

## Glass Passivated Bridge Rectifiers

### FEATURES

- Glass passivated junction
- Ideal for automated placement
- Reliable low cost construction utilizing molded plastic technique
- High surge current capability
- Moisture sensitivity level: level 1, per J-STD-020
- Compliant to RoHS Directive 2011/65/EU and in accordance to WEEE 2002/96/EC
- Halogen-free according to IEC 61249-2-21 definition



ABS



### MECHANICAL DATA

**Case:** Molded plastic body

Molding compound, UL flammability classification rating 94V-0

Base P/N with suffix "G" on packing code - halogen-free

**Terminal:** Matte tin plated leads, solderable per JESD22-B102

Meet JESD 201 class 1A whisker test

**Polarity:** Polarity as marked on the body

**Weight:** 0.096 g (approximately)

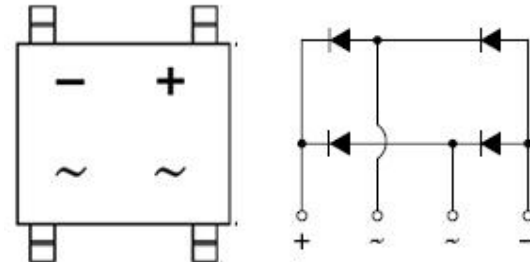

MAXIMUM RATINGS AND ELECTRICAL CHARACTERISTICS (T <sub>A</sub> =25°C unless otherwise noted)				
PARAMETER	SYMBOL	ABS15J	ABS15M	Unit
Maximum repetitive peak reverse voltage	V <sub>RRM</sub>	600	1000	V
Maximum RMS voltage	V <sub>RMS</sub>	420	700	V
Maximum DC blocking voltage	V <sub>DC</sub>	600	1000	V
Maximum average forward rectified current	I <sub>F(AV)</sub>	1.5		A
Peak forward surge current, 8.3 ms single half sine-wave superimposed on rated load	I <sub>FSM</sub>	40		A
Rating for fusing (t<8.3ms)	I <sup>2</sup> t	6.64		A <sup>2</sup> s
Maximum instantaneous forward voltage (Note 1) I <sub>F</sub> = 0.5 A I <sub>F</sub> = 1.5 A	V <sub>F</sub>	Typ.	Max.	V
		0.88	-	
		0.97	1.00	
Maximum DC reverse current at rated DC blocking voltage	I <sub>R</sub>	T <sub>J</sub> =25 °C	5	μA
		T <sub>J</sub> =125°C	150	
Typical thermal resistance	R <sub>θJL</sub>	25		°C/W
	R <sub>θJA</sub>	80		
Operating junction temperature range	T <sub>J</sub>	- 55 to +150		°C
Storage temperature range	T <sub>STG</sub>	- 55 to +150		°C

Note 1: Pulse test with PW=300μs, 1% duty cycle

**ORDERING INFORMATION**

PART NO.	PACKING CODE	GREEN COMPOUND CODE	PACKAGE	PACKING
ABS15x (Note 1)	RE	Suffix "G"	ABS	1,000 / 7" Plastic reel
	RG		ABS	5,000 / 13" Paper reel

Note 1: "x" defines voltage from 600V (ABS15J) to 1000V (ABS15M)

Note 2: For ABS: Packing code (Whole series with green compound)

**EXAMPLE**

PREFERRED P/N	PART NO.	PACKING CODE	GREEN COMPOUND CODE	DESCRIPTION
ABS15J REG	ABS15J	RE	G	Green compound

**RATINGS AND CHARACTERISTICS CURVES**

(TA=25°C unless otherwise noted)

FIG.1 MAXIMUM FORWARD CURRENT DERATING CURVE

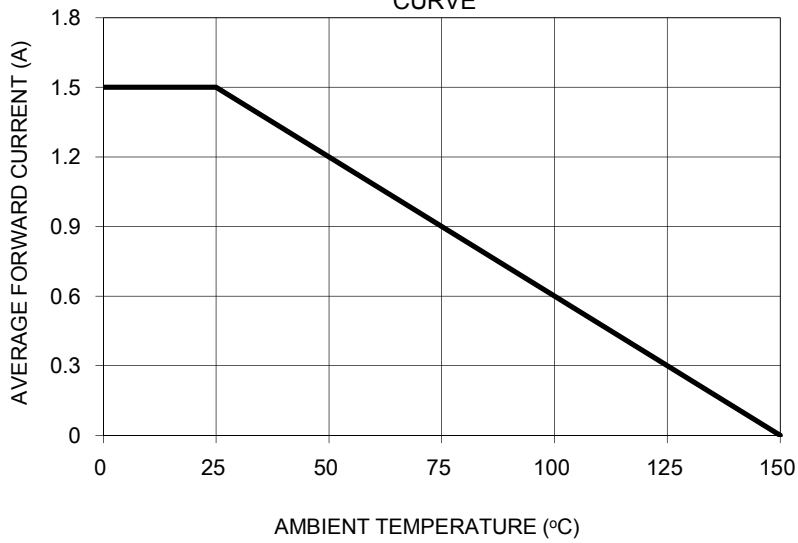

FIG. 2 TYPICAL REVERSE CHARACTERISTICS

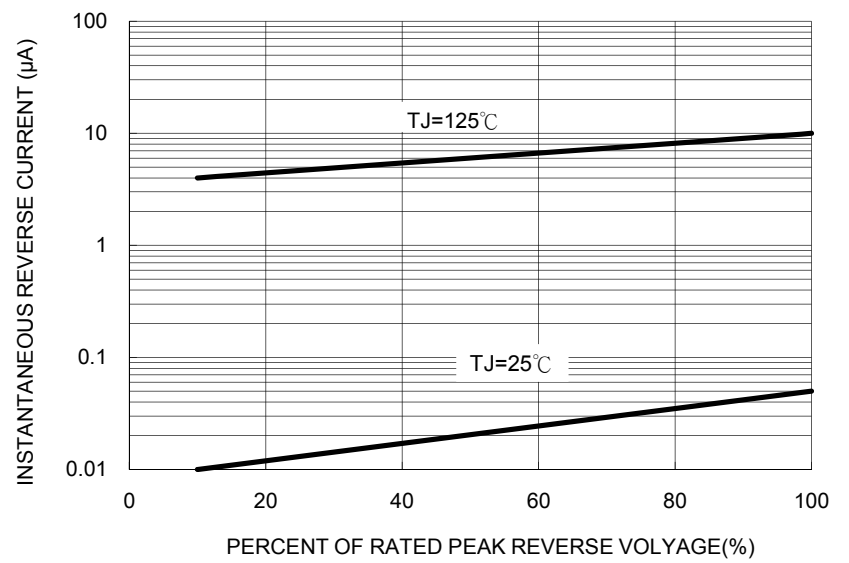

FIG. 3 MAXIMUM NON-REPETITIVE FORWARD SURGE CURRENT

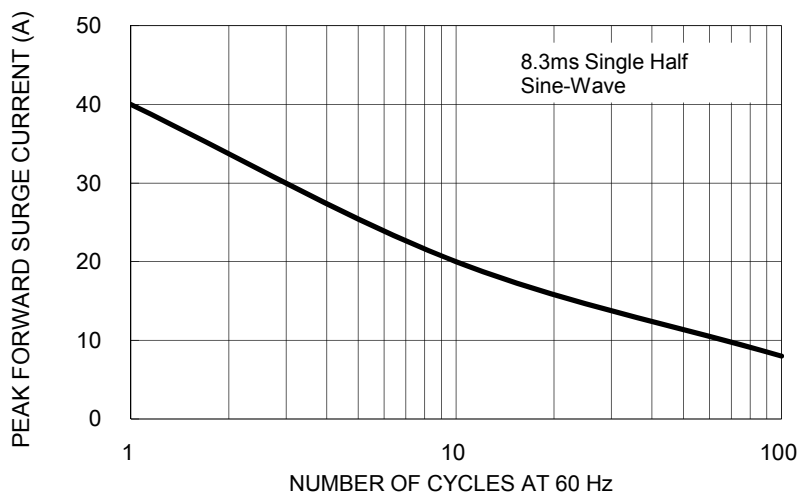

FIG. 4 TYPICAL JUNCTION CAPACITANCE

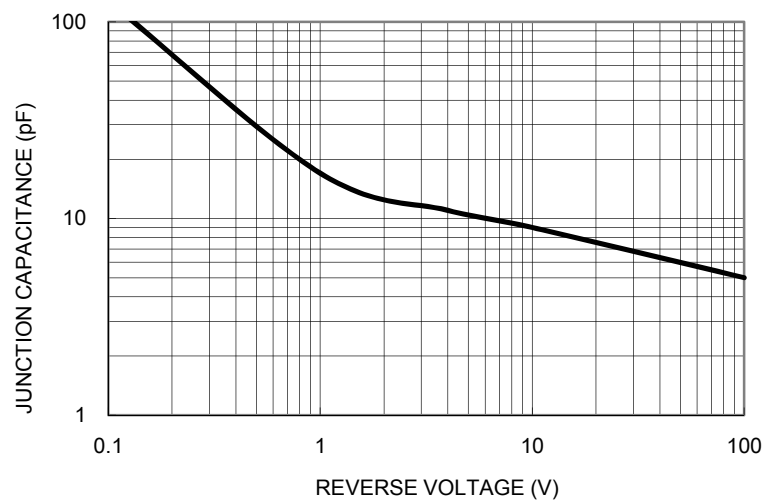
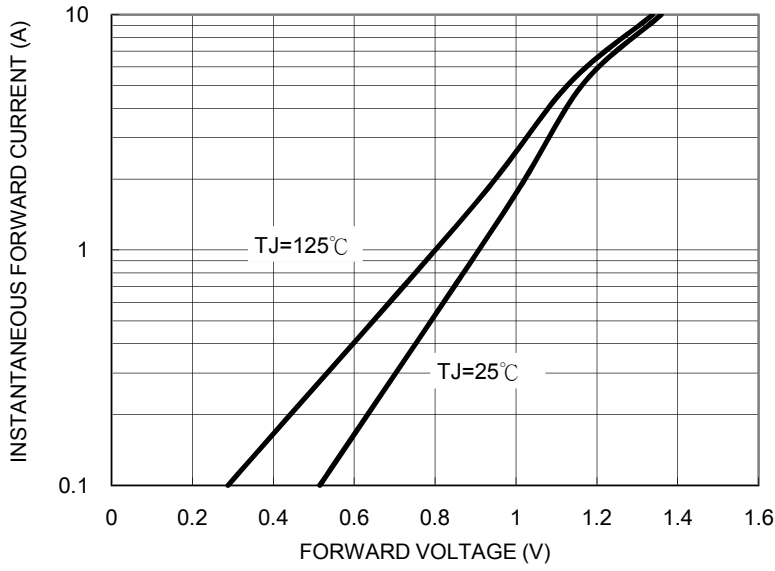
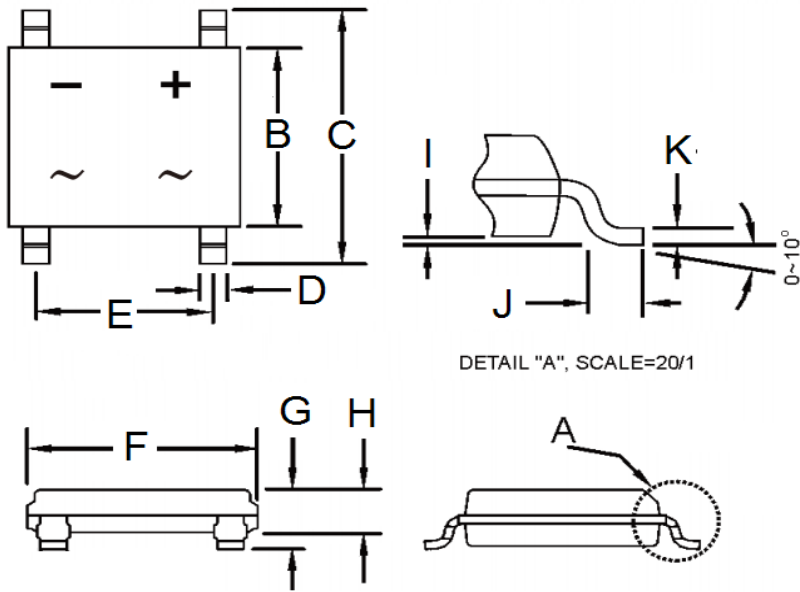

FIG. 5 TYPICAL FORWARD CHARACTERISTICS



PACKAGE OUTLINE DIMENSIONS



DIM.	Unit (mm)		Unit (inch)	
	Min	Max	Min	Max
B	4.30	4.50	0.169	0.177
C	6.25	6.65	0.246	0.262
D	0.60	0.70	0.024	0.028
E	3.90	4.10	0.154	0.161
F	4.90	5.10	0.193	0.200
G	1.40	1.60	0.055	0.063
H	1.35	1.45	0.053	0.057
I	0.05	0.15	0.002	0.006
J	0.30	0.70	0.012	0.028
K	0.15	0.25	0.006	0.010

SUGGESTED PAD LAYOUT

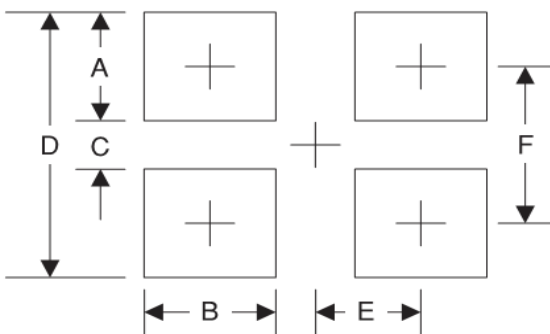

Symbol	Unit (mm)	Unit (inch)
A	1.5	0.059
B	0.9	0.035
C	4.22	0.166
D	7.22	0.284
E	2.05	0.081
F	5.72	0.225

MARKING DIAGRAM



P/N = Specific Device Code  
 YW = Date Code  
 F = Factory Code

## Notice

Specifications of the products displayed herein are subject to change without notice. TSC or anyone on its behalf, assumes no responsibility or liability for any errors inaccuracies.

Information contained herein is intended to provide a product description only. No license, express or implied, to any intellectual property rights is granted by this document. Except as provided in TSC's terms and conditions of sale for such products, TSC assumes no liability whatsoever, and disclaims any express or implied warranty, relating to sale and/or use of TSC products including liability or warranties relating to fitness for a particular purpose, merchantability, or infringement of any patent, copyright, or other intellectual property right.

The products shown herein are not designed for use in medical, life-saving, or life-sustaining applications. Customers using or selling these products for use in such applications do so at their own risk and agree to fully indemnify TSC for any damages resulting from such improper use or sale.