

## 650 V power Schottky silicon carbide diode

Datasheet - production data

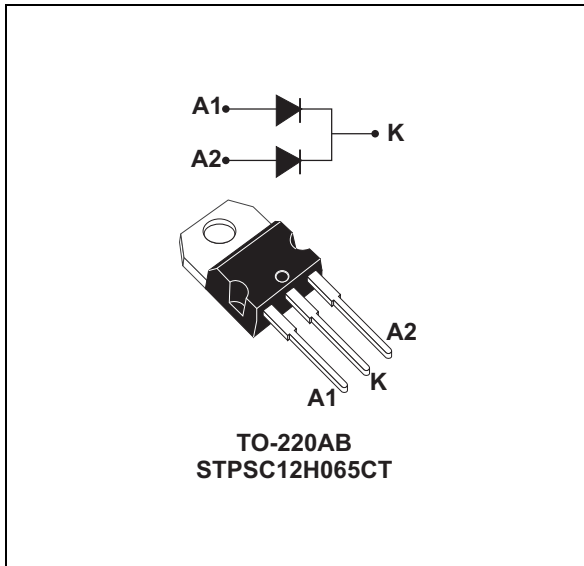

### Description

The SiC diode is an ultrahigh performance power Schottky diode. It is manufactured using a silicon carbide substrate. The wide band gap material allows the design of a Schottky diode structure with a 650 V rating. Due to the Schottky construction, no recovery is shown at turn-off and ringing patterns are negligible. The minimized capacitive charge at turn-off behavior is independent of temperature.

Especially suited for use in interleaved or bridgeless topologies, this dual-diode rectifier will boost the performance in hard switching conditions. Its high forward surge capability ensures a good robustness during transient phases.

Table 1. Device summary

Symbol	Value
$I_{F(AV)}$	2 x 6 A
$V_{RRM}$	650 V
$T_j$ (max)	175 °C

### Features

- No or negligible reverse recovery
- Switching behavior independent of temperature
- High forward surge capability

# 1 Characteristics

**Table 2. Absolute ratings (limiting values per diode at 25 °C unless otherwise specified)**

Symbol	Parameter		Value	Unit
V <sub>RRM</sub>	Repetitive peak reverse voltage		650	V
I <sub>F(RMS)</sub>	Forward rms current		22	A
I <sub>F(AV)</sub>	Average forward current	T <sub>c</sub> = 135 °C <sup>(1)</sup> , DC Per diode	6	A
		T <sub>c</sub> = 135 °C <sup>(2)</sup> , DC Per device	12	A
I <sub>FSM</sub>	Surge non repetitive forward current	t <sub>p</sub> = 10 ms sinusoidal, T <sub>c</sub> = 25 °C	60	A
		t <sub>p</sub> = 10 ms sinusoidal, T <sub>c</sub> = 125 °C	52	
		t <sub>p</sub> = 10 μs square, T <sub>c</sub> = 25 °C	400	
I <sub>FRM</sub>	Repetitive peak forward current	T <sub>c</sub> = 135 °C <sup>(1)</sup> , T <sub>j</sub> = 175 °C, δ = 0.1	25	A
T <sub>stg</sub>	Storage temperature range		-65 to +175	°C
T <sub>j</sub>	Operating junction temperature <sup>(3)</sup>		-40 to +175	°C

1. Value based on R<sub>th(j-c)</sub> max (per diode)
2. Value based on R<sub>th(j-c)</sub> max (per device)
3.  $\frac{dP_{tot}}{dT_j} < \frac{1}{R_{th(j-a)}}$  condition to avoid thermal runaway for a diode on its own heatsink

**Table 3. Thermal resistance parameters**

Symbol	Parameter		Typ.	Max.	Unit
R <sub>th(j-c)</sub>	Junction to case	Per diode	1.6	2.4	°C/W
		Per device	0.875	1.275	
R <sub>th(c)</sub>	Coupling		-	0.15	

When the diodes 1 and 2 are used simultaneously:

$$\Delta T_j(\text{diode 1}) = P(\text{diode1}) \times R_{th(j-c)}(\text{Per diode}) + P(\text{diode2}) \times R_{th(c)}$$

**Table 4. Static electrical characteristics (per diode)**

Symbol	Parameter	Tests conditions		Min.	Typ.	Max.	Unit
I <sub>R</sub> <sup>(1)</sup>	Reverse leakage current	T <sub>j</sub> = 25 °C	V <sub>R</sub> = V <sub>RRM</sub>	-	5	60	μA
		T <sub>j</sub> = 150 °C		-	50	250	
V <sub>F</sub> <sup>(2)</sup>	Forward voltage drop	T <sub>j</sub> = 25 °C	I <sub>F</sub> = 6 A	-	1.56	1.75	V
		T <sub>j</sub> = 150 °C		-	1.98	2.5	

1. t<sub>p</sub> = 10 ms, δ < 2%
2. t<sub>p</sub> = 500 μs, δ < 2%

To evaluate the conduction losses use the following equation:

$$P = 1.35 \times I_{F(AV)} + 0.192 \times I_{F(RMS)}^2$$

Table 5. Dynamic electrical characteristics (per diode)

Symbol	Parameter	Test conditions	Typ.	Unit
$Q_{cj}^{(1)}$	Total capacitive charge	$V_R = 400\text{ V}$	18	nC
$C_j$	Total capacitance	$V_R = 0\text{ V}, T_C = 25\text{ }^\circ\text{C}, F = 1\text{ MHz}$	300	pF
		$V_R = 400\text{ V}, T_C = 25\text{ }^\circ\text{C}, F = 1\text{ MHz}$	30	

1. Most accurate value for the capacitive charge:  $Q_{cj} = \int_0^{V_{OUT}} c_j(V_R).dv_R$

Figure 1. Forward voltage drop versus forward current (typical values, low level, per diode)

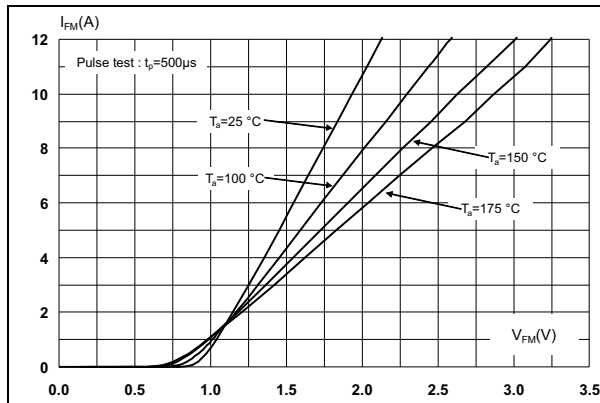

Figure 2. Forward voltage drop versus forward current (typical values, high level, per diode)

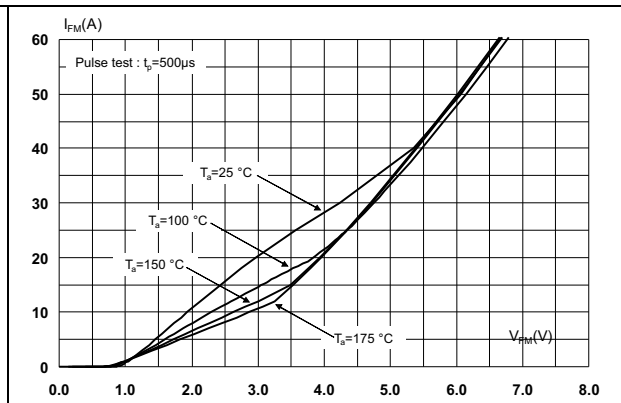

Figure 3. Reverse leakage current versus reverse voltage applied (typical values, per diode)

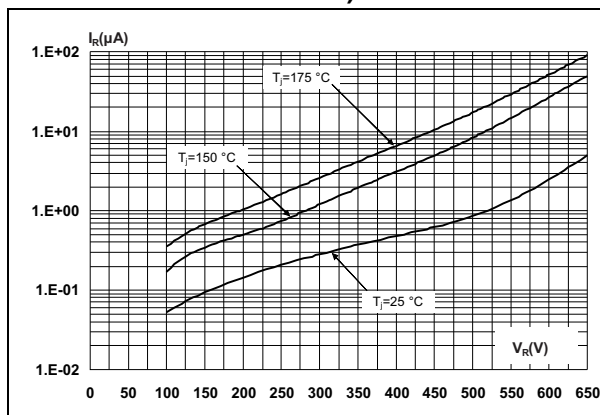

Figure 4. Peak forward current versus case temperature (per diode)

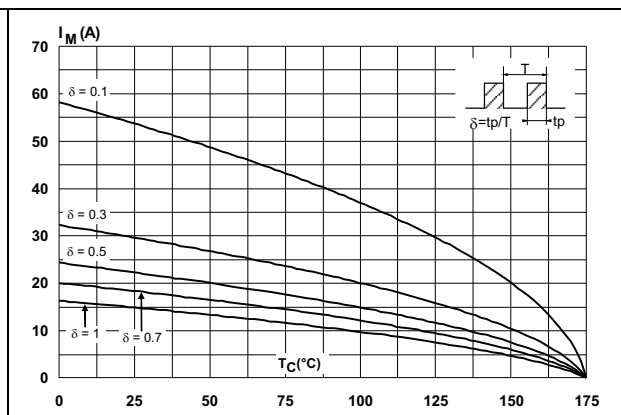

Figure 5. Junction capacitance versus reverse voltage applied (typical values, per diode)

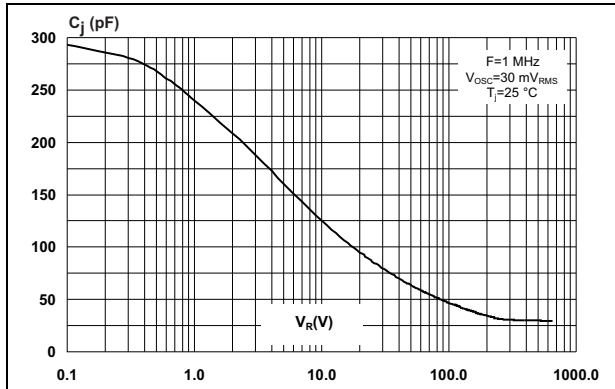

Figure 6. Relative variation of thermal impedance junction to case versus pulse duration

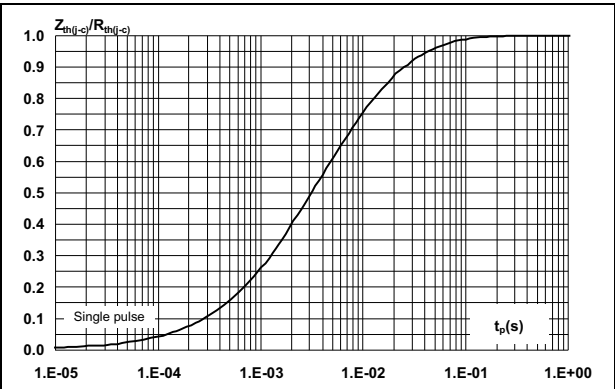

Figure 7. Non-repetitive peak surge forward current versus pulse duration (sinusoidal waveform, per diode)

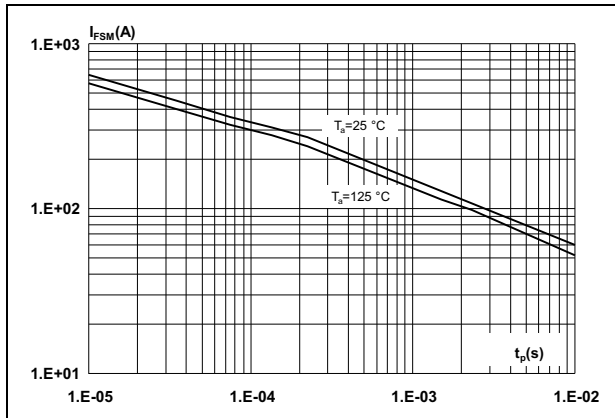
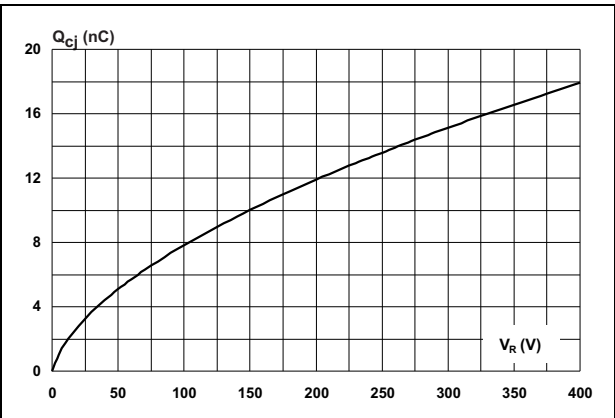

Figure 8. Total capacitive charges versus reverse voltage applied (typical values, per diode)



## 2 Package information

- Epoxy meets UL94, V0
- Cooling method: conduction (C)
- Recommended torque value: 0.4 to 0.6 N·m

In order to meet environmental requirements, ST offers these devices in different grades of ECOPACK® packages, depending on their level of environmental compliance. ECOPACK® specifications, grade definitions and product status are available at: [www.st.com](http://www.st.com). ECOPACK® is an ST trademark.

Figure 9. TO-220AB dimension definitions

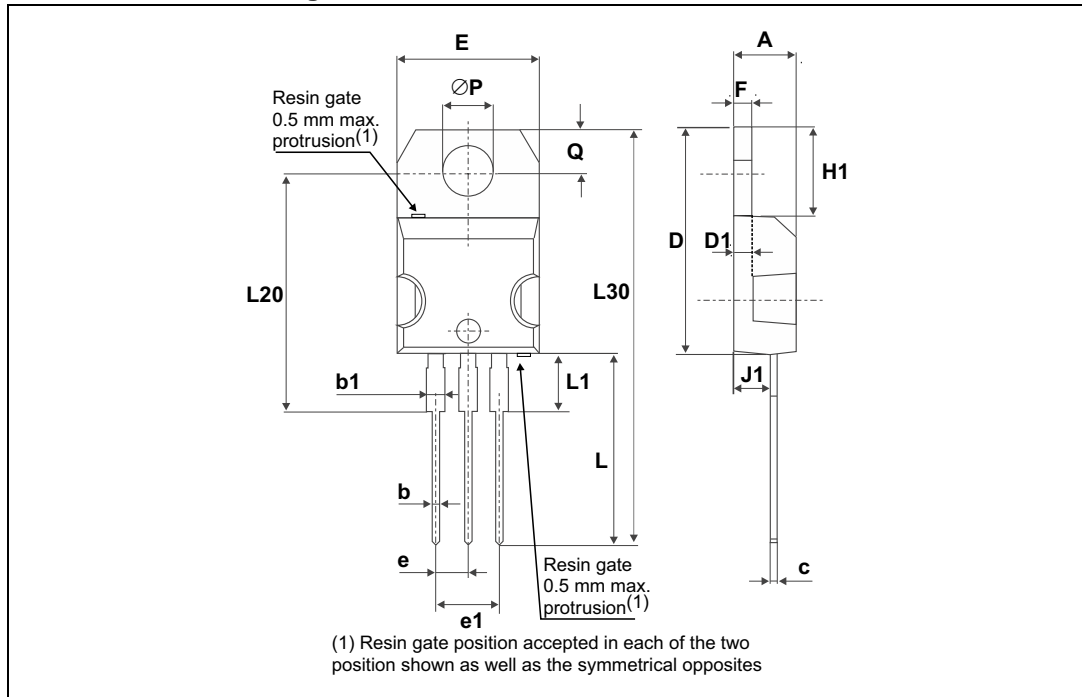

Table 6. TO-220AB dimensions values

Ref.	Dimensions			
	Millimeters		Inches	
	Min.	Max.	Min.	Max.
A	4.40	4.60	0.17	0.18
b	0.61	0.88	0.024	0.035
b1	1.14	1.70	0.045	0.067
c	0.48	0.70	0.019	0.027
D	15.25	15.75	0.60	0.62
D1	1.27 typ.		0.05 typ.	
E	10	10.40	0.39	0.41
e	2.40	2.70	0.094	0.106
e1	4.95	5.15	0.19	0.20
F	1.23	1.32	0.048	0.052
H1	6.20	6.60	0.24	0.26
J1	2.40	2.72	0.094	0.107
L	13	14	0.51	0.55
L1	3.50	3.93	0.137	0.154
L20	16.40 typ.		0.64 typ.	
L30	28.90 typ.		1.13 typ.	
∅P	3.75	3.85	0.147	0.151
Q	2.65	2.95	0.104	0.116

### 3 Ordering information

Table 7. Ordering information

Order code	Marking	Package	Weight	Base qty	Delivery mode
STPSC12H065CT	STPSC12H065CT	TO-220AB	1.86 g	50	Tube

### 4 Revision history

Table 8. Document revision history

Date	Revision	Changes
24-Jun-2013	1	First issue.
07-Nov-2013	2	Updated <a href="#">Figure 1</a> and <a href="#">Figure 2</a> .

**Please Read Carefully:**

Information in this document is provided solely in connection with ST products. STMicroelectronics NV and its subsidiaries ("ST") reserve the right to make changes, corrections, modifications or improvements, to this document, and the products and services described herein at any time, without notice.

All ST products are sold pursuant to ST's terms and conditions of sale.

Purchasers are solely responsible for the choice, selection and use of the ST products and services described herein, and ST assumes no liability whatsoever relating to the choice, selection or use of the ST products and services described herein.

No license, express or implied, by estoppel or otherwise, to any intellectual property rights is granted under this document. If any part of this document refers to any third party products or services it shall not be deemed a license grant by ST for the use of such third party products or services, or any intellectual property contained therein or considered as a warranty covering the use in any manner whatsoever of such third party products or services or any intellectual property contained therein.

**UNLESS OTHERWISE SET FORTH IN ST'S TERMS AND CONDITIONS OF SALE ST DISCLAIMS ANY EXPRESS OR IMPLIED WARRANTY WITH RESPECT TO THE USE AND/OR SALE OF ST PRODUCTS INCLUDING WITHOUT LIMITATION IMPLIED WARRANTIES OF MERCHANTABILITY, FITNESS FOR A PARTICULAR PURPOSE (AND THEIR EQUIVALENTS UNDER THE LAWS OF ANY JURISDICTION), OR INFRINGEMENT OF ANY PATENT, COPYRIGHT OR OTHER INTELLECTUAL PROPERTY RIGHT.**

**ST PRODUCTS ARE NOT DESIGNED OR AUTHORIZED FOR USE IN: (A) SAFETY CRITICAL APPLICATIONS SUCH AS LIFE SUPPORTING, ACTIVE IMPLANTED DEVICES OR SYSTEMS WITH PRODUCT FUNCTIONAL SAFETY REQUIREMENTS; (B) AERONAUTIC APPLICATIONS; (C) AUTOMOTIVE APPLICATIONS OR ENVIRONMENTS, AND/OR (D) AEROSPACE APPLICATIONS OR ENVIRONMENTS. WHERE ST PRODUCTS ARE NOT DESIGNED FOR SUCH USE, THE PURCHASER SHALL USE PRODUCTS AT PURCHASER'S SOLE RISK, EVEN IF ST HAS BEEN INFORMED IN WRITING OF SUCH USAGE, UNLESS A PRODUCT IS EXPRESSLY DESIGNATED BY ST AS BEING INTENDED FOR "AUTOMOTIVE, AUTOMOTIVE SAFETY OR MEDICAL" INDUSTRY DOMAINS ACCORDING TO ST PRODUCT DESIGN SPECIFICATIONS. PRODUCTS FORMALLY ESCC, QML OR JAN QUALIFIED ARE DEEMED SUITABLE FOR USE IN AEROSPACE BY THE CORRESPONDING GOVERNMENTAL AGENCY.**

Resale of ST products with provisions different from the statements and/or technical features set forth in this document shall immediately void any warranty granted by ST for the ST product or service described herein and shall not create or extend in any manner whatsoever, any liability of ST.

ST and the ST logo are trademarks or registered trademarks of ST in various countries.

Information in this document supersedes and replaces all information previously supplied.

The ST logo is a registered trademark of STMicroelectronics. All other names are the property of their respective owners.

© 2013 STMicroelectronics - All rights reserved

STMicroelectronics group of companies

Australia - Belgium - Brazil - Canada - China - Czech Republic - Finland - France - Germany - Hong Kong - India - Israel - Italy - Japan - Malaysia - Malta - Morocco - Philippines - Singapore - Spain - Sweden - Switzerland - United Kingdom - United States of America

[www.st.com](http://www.st.com)