

**TLV2221, TLV2221Y**  
**Advanced LinCMOS™ RAIL-TO-RAIL**  
**VERY LOW-POWER SINGLE OPERATIONAL AMPLIFIERS**

SLOS157B – JUNE 1996 – REVISED APRIL 2005

- **Output Swing Includes Both Supply Rails**
- **Low Noise . . . 19 nV/√Hz Typ at f = 1 kHz**
- **Low Input Bias Current . . . 1 pA Typ**
- **Fully Specified for Single-Supply 3-V and 5-V Operation**
- **Very Low Power . . . 110 μA Typ**
- **Common-Mode Input Voltage Range Includes Negative Rail**
- **Wide Supply Voltage Range 2.7 V to 10 V**
- **Macromodel Included**

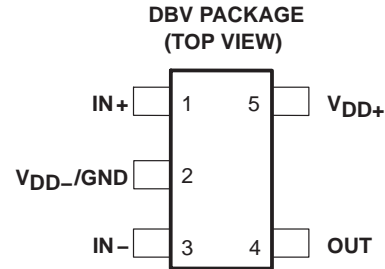

### description

The TLV2221 is a single low-voltage operational amplifier available in the SOT-23 package. It offers a compromise between the ac performance and output drive of the TLV2231 and the micropower TLV2211.

It consumes only 150 μA (max) of supply current and is ideal for battery-powered applications. The device exhibits rail-to-rail output performance for increased dynamic range in single- or split-supply applications. The TLV2221 is fully characterized at 3 V and 5 V and is optimized for low-voltage applications.

The TLV2221, exhibiting high input impedance and low noise, is excellent for small-signal conditioning for high-impedance sources, such as piezoelectric transducers. Because of the micropower dissipation levels combined with 3-V operation, these devices work well in hand-held monitoring and remote-sensing applications. In addition, the rail-to-rail output feature with single or split supplies makes this family a great choice when interfacing with analog-to-digital converters (ADCs).

With a total area of 5.6mm<sup>2</sup>, the SOT-23 package only requires one third the board space of the standard 8-pin SOIC package. This ultra-small package allows designers to place single amplifiers very close to the signal source, minimizing noise pick-up from long PCB traces. TI has also taken special care to provide a pinout that is optimized for board layout (see Figure 1). Both inputs are separated by GND to prevent coupling or leakage paths. The OUT and IN– terminals are on the same end of the board to provide negative feedback. Finally, gain setting resistors and decoupling capacitor are easily placed around the package.

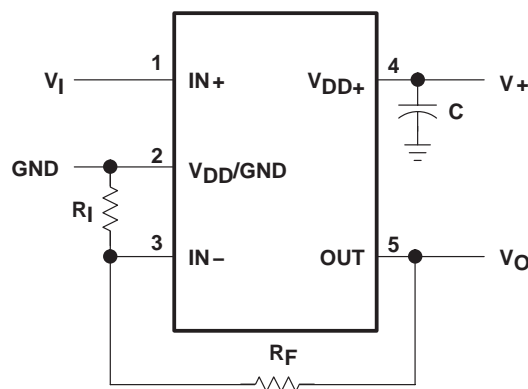

**Figure 1. Typical Surface Mount Layout for a Fixed-Gain Noninverting Amplifier**



Please be aware that an important notice concerning availability, standard warranty, and use in critical applications of Texas Instruments semiconductor products and disclaimers thereto appears at the end of this data sheet.

Advanced LinCMOS is a trademark of Texas Instruments Incorporated.

PRODUCTION DATA information is current as of publication date. Products conform to specifications per the terms of Texas Instruments standard warranty. Production processing does not necessarily include testing of all parameters.



Copyright © 1997 –2005, Texas Instruments Incorporated

# TLV2221, TLV2221Y

## Advanced LinCMOS™ RAIL-TO-RAIL

### VERY LOW-POWER SINGLE OPERATIONAL AMPLIFIERS

SLOS157B – JUNE 1996 – REVISED APRIL 2005

#### AVAILABLE OPTIONS

T <sub>A</sub>	V <sub>IO</sub> max AT 25°C	PACKAGED DEVICES	SYMBOL	CHIP FORM‡ (Y)
		SOT-23 (DBV)†		
0°C to 70°C	3 mV	TLV2221CDBV	VADC	TLV2221Y
-40°C to 85°C	3 mV	TLV2221IDBV	VADI	

† The DBV package available in tape and reel only.

‡ Chip forms are tested at T<sub>A</sub> = 25°C only.

#### TLV2221Y chip information

This chip, when properly assembled, displays characteristics similar to the TLV2221C. Thermal compression or ultrasonic bonding may be used on the doped-aluminum bonding pads. This chip may be mounted with conductive epoxy or a gold-silicon preform.

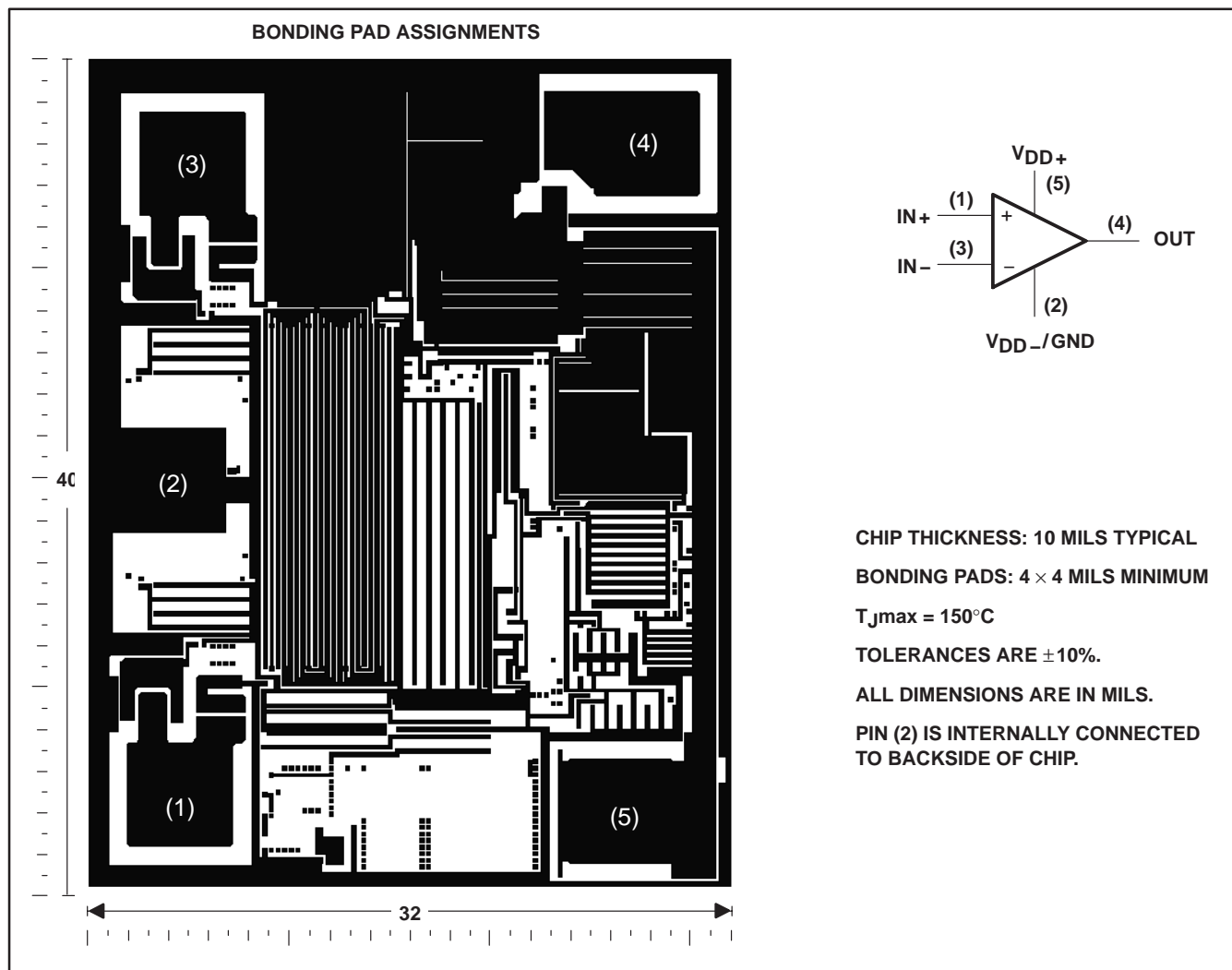

equivalent schematic

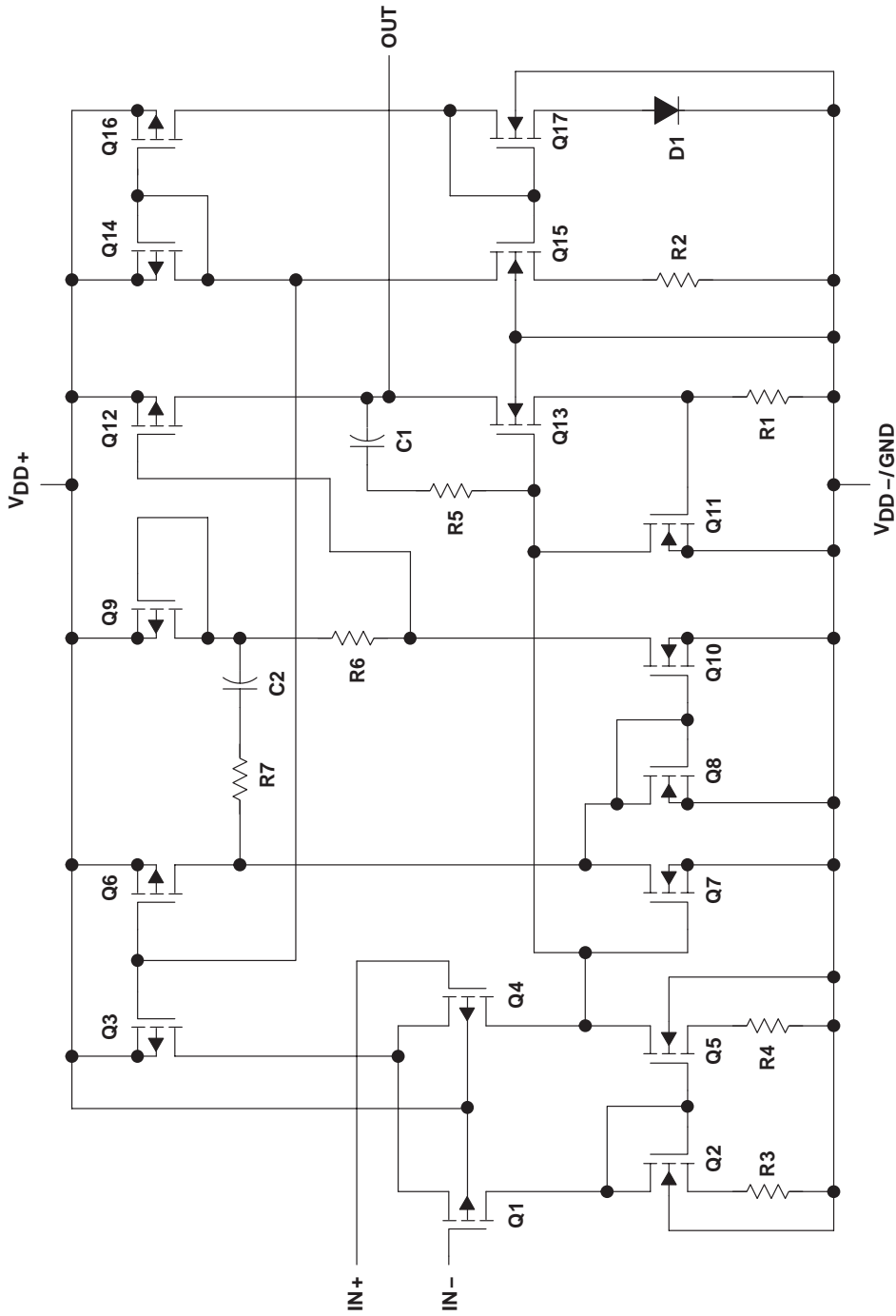

COMPONENT COUNT†	
Transistors	23
Diodes	5
Resistors	11
Capacitors	2

† Includes both amplifiers and all ESD, bias, and trim circuitry

**TLV2221, TLV2221Y**  
**Advanced LinCMOS™ RAIL-TO-RAIL**  
**VERY LOW-POWER SINGLE OPERATIONAL AMPLIFIERS**

SLOS157B – JUNE 1996 – REVISED APRIL 2005

**absolute maximum ratings over operating free-air temperature range (unless otherwise noted)†**

Supply voltage, $V_{DD}$ (see Note 1)	12 V
Differential input voltage, $V_{ID}$ (see Note 2)	$\pm V_{DD}$
Input voltage range, $V_I$ (any input, see Note 1)	-0.3 V to $V_{DD}$
Input current, $I_I$ (each input)	$\pm 5$ mA
Output current, $I_O$	$\pm 50$ mA
Total current into $V_{DD+}$	$\pm 50$ mA
Total current out of $V_{DD-}$	$\pm 50$ mA
Duration of short-circuit current (at or below) 25°C (see Note 3)	unlimited
Continuous total power dissipation	See Dissipation Rating Table
Operating free-air temperature range, $T_A$ : TLV2221C	0°C to 70°C
TLV2221I	-40°C to 85°C
Storage temperature range, $T_{stg}$	-65°C to 150°C
Lead temperature 1,6 mm (1/16 inch) from case for 10 seconds: DBV package	260°C

† Stresses beyond those listed under “absolute maximum ratings” may cause permanent damage to the device. These are stress ratings only, and functional operation of the device at these or any other conditions beyond those indicated under “recommended operating conditions” is not implied. Exposure to absolute-maximum-rated conditions for extended periods may affect device reliability.

- NOTES: 1. All voltage values, except differential voltages, are with respect to  $V_{DD-}$ .  
 2. Differential voltages are at the noninverting input with respect to the inverting input. Excessive current flows when input is brought below  $V_{DD-} - 0.3$  V.  
 3. The output can be shorted to either supply. Temperature and/or supply voltages must be limited to ensure that the maximum dissipation rating is not exceeded.

**DISSIPATION RATING TABLE**

PACKAGE	$T_A \leq 25^\circ\text{C}$ POWER RATING	DERATING FACTOR ABOVE $T_A = 25^\circ\text{C}$	$T_A = 70^\circ\text{C}$ POWER RATING	$T_A = 85^\circ\text{C}$ POWER RATING
DBV	150 mW	1.2 mW/°C	96 mW	78 mW

**recommended operating conditions**

	TLV2221C		TLV2221I		UNIT
	MIN	MAX	MIN	MAX	
Supply voltage, $V_{DD}$ (see Note 1)	2.7	10	2.7	10	V
Input voltage range, $V_I$	$V_{DD-}$	$V_{DD+} - 1.3$	$V_{DD-}$	$V_{DD+} - 1.3$	V
Common-mode input voltage, $V_{IC}$	$V_{DD-}$	$V_{DD+} - 1.3$	$V_{DD-}$	$V_{DD+} - 1.3$	V
Operating free-air temperature, $T_A$	0	70	-40	85	°C

NOTE 1: All voltage values, except differential voltages, are with respect to  $V_{DD-}$ .

**TLV2221, TLV2221Y**  
**Advanced LinCMOS™ RAIL-TO-RAIL**  
**VERY LOW-POWER SINGLE OPERATIONAL AMPLIFIERS**

SLOS157B – JUNE 1996 – REVISED APRIL 2005

**electrical characteristics at specified free-air temperature,  $V_{DD} = 3\text{ V}$  (unless otherwise noted)**

PARAMETER	TEST CONDITIONS	$T_A$ †	TLV2221C			TLV2221I			UNIT
			MIN	TYP	MAX	MIN	TYP	MAX	
$V_{IO}$ Input offset voltage	$V_{DD\pm} = \pm 1.5\text{ V}$ , $V_{IC} = 0$ , $V_O = 0$ , $R_S = 50\ \Omega$	Full range	0.62		3	0.62		3	mV
$\alpha_{V_{IO}}$ Temperature coefficient of input offset voltage			1		1		$\mu\text{V}/^\circ\text{C}$		
Input offset voltage long-term drift (see Note 4)		25°C	0.003		0.003		$\mu\text{V}/\text{mo}$		
$I_{IO}$ Input offset current		25°C	0.5		0.5		pA		
		Full range	150		150				
$I_{IB}$ Input bias current		25°C	1		1		pA		
	Full range	150		150					
$V_{ICR}$ Common-mode input voltage range	$R_S = 50\ \Omega$ , $ V_{IO}  \leq 5\text{ mV}$	25°C	0 to 2	-0.3 to 2.2	0 to 2	-0.3 to 2.2	V		
		Full range	0 to 1.7		0 to 1.7				
$V_{OH}$ High-level output voltage	$I_{OH} = -100\ \mu\text{A}$ $I_{OH} = -400\ \mu\text{A}$	25°C	2.97		2.97		V		
		25°C	2.88		2.88				
		Full range	2.5		2.5				
$V_{OL}$ Low-level output voltage	$V_{IC} = 1.5\text{ V}$ , $I_{OL} = 50\ \mu\text{A}$ $V_{IC} = 1.5\text{ V}$ , $I_{OL} = 500\ \mu\text{A}$	25°C	15		15		mV		
		25°C	150		150				
		Full range	500		500				
$A_{VD}$ Large-signal differential voltage amplification	$V_{IC} = 1.5\text{ V}$ , $V_O = 1\text{ V to } 2\text{ V}$	25°C	$R_L = 2\text{ k}\Omega$ ‡		2 3		V/mV		
			Full range		1				
		25°C	$R_L = 1\text{ M}\Omega$ ‡		250				
$r_{id}$ Differential input resistance		25°C	$10^{12}$		$10^{12}$		$\Omega$		
$r_{ic}$ Common-mode input resistance		25°C	$10^{12}$		$10^{12}$		$\Omega$		
$c_{ic}$ Common-mode input capacitance	$f = 10\text{ kHz}$	25°C	6		6		pF		
$z_o$ Closed-loop output impedance	$f = 10\text{ kHz}$ , $A_V = 10$	25°C	90		90		$\Omega$		
CMRR Common-mode rejection ratio	$V_{IC} = 0\text{ to } 1.7\text{ V}$ , $V_O = 1.5\text{ V}$ , $R_S = 50\ \Omega$	25°C	70	82	70	82	dB		
		Full range	65		65				
$k_{SVR}$ Supply voltage rejection ratio ( $\Delta V_{DD} / \Delta V_{IO}$ )	$V_{DD} = 2.7\text{ V to } 8\text{ V}$ , $V_{IC} = V_{DD}/2$ , No load	25°C	80	95	80	95	dB		
		Full range	80		80				
$I_{DD}$ Supply current	$V_O = 1.5\text{ V}$ , No load	25°C	100	150	100	150	$\mu\text{A}$		
		Full range	200		200				

† Full range for the TLV2221C is 0°C to 70°C. Full range for the TLV2221I is -40°C to 85°C.

‡ Referenced to 1.5 V

NOTE 4: Typical values are based on the input offset voltage shift observed through 500 hours of operating life test at  $T_A = 150^\circ\text{C}$  extrapolated to  $T_A = 25^\circ\text{C}$  using the Arrhenius equation and assuming an activation energy of 0.96 eV.

**TLV2221, TLV2221Y**  
**Advanced LinCMOS™ RAIL-TO-RAIL**  
**VERY LOW-POWER SINGLE OPERATIONAL AMPLIFIERS**

SLOS157B – JUNE 1996 – REVISED APRIL 2005

operating characteristics at specified free-air temperature,  $V_{DD} = 3\text{ V}$

PARAMETER	TEST CONDITIONS		$T_A$ †	TLV2221C			TLV2221I			UNIT
				MIN	TYP	MAX	MIN	TYP	MAX	
SR	Slew rate at unity gain	$V_O = 1.1\text{ V to }1.9\text{ V}, R_L = 2\text{ k}\Omega^\ddagger, C_L = 100\text{ pF}^\ddagger$	25°C	0.1	0.18		0.1	0.18		V/ $\mu\text{s}$
			Full range	0.05			0.05			
$V_n$	Equivalent input noise voltage	$f = 10\text{ Hz}$ $f = 1\text{ kHz}$	25°C		120			120		nV/ $\sqrt{\text{Hz}}$
			25°C		20			20		
$V_{N(PP)}$	Peak-to-peak equivalent input noise voltage	$f = 0.1\text{ Hz to }1\text{ Hz}$ $f = 0.1\text{ Hz to }10\text{ Hz}$	25°C		680			680		nV
			25°C		860			860		
$I_n$	Equivalent input noise current		25°C		0.6			0.6	fA/ $\sqrt{\text{Hz}}$	
THD+N	Total harmonic distortion plus noise	$V_O = 1\text{ V to }2\text{ V}, f = 20\text{ kHz}, R_L = 2\text{ k}\Omega^\ddagger$	25°C	$A_V = 1$		2.52%		2.52%		
				$A_V = 10$		7.01%		7.01%		
		$V_O = 1\text{ V to }2\text{ V}, f = 20\text{ kHz}, R_L = 2\text{ k}\Omega^\S$	25°C	$A_V = 1$		0.076%		0.076%		
				$A_V = 10$		0.147%		0.147%		
	Gain-bandwidth product	$f = 1\text{ kHz}, C_L = 100\text{ pF}^\ddagger, R_L = 2\text{ k}\Omega^\ddagger$	25°C		480			480	kHz	
BOM	Maximum output-swing bandwidth	$V_{O(PP)} = 1\text{ V}, R_L = 2\text{ k}\Omega^\ddagger, A_V = 1, C_L = 100\text{ pF}^\ddagger$	25°C		30			30	kHz	
$t_s$	Settling time	$A_V = -1, \text{ Step} = 1\text{ V to }2\text{ V}, R_L = 2\text{ k}\Omega^\ddagger, C_L = 100\text{ pF}^\ddagger$	25°C		To 0.1%			4.5		$\mu\text{s}$
			25°C		To 0.01%			6.8		$\mu\text{s}$
$\phi_m$	Phase margin at unity gain	$R_L = 2\text{ k}\Omega^\ddagger, C_L = 100\text{ pF}^\ddagger$	25°C		51°			51°		
	Gain margin		25°C		12			12		dB

† Full range is  $-40^\circ\text{C to }85^\circ\text{C}$ .

‡ Referenced to 1.5 V

§ Referenced to 0 V

**TLV2221, TLV2221Y**  
**Advanced LinCMOS™ RAIL-TO-RAIL**  
**VERY LOW-POWER SINGLE OPERATIONAL AMPLIFIERS**

SLOS157B – JUNE 1996 – REVISED APRIL 2005

**electrical characteristics at specified free-air temperature,  $V_{DD} = 5\text{ V}$  (unless otherwise noted)**

PARAMETER	TEST CONDITIONS	$T_A$ †	TLV2221C			TLV2221I			UNIT
			MIN	TYP	MAX	MIN	TYP	MAX	
$V_{IO}$ Input offset voltage	$V_{DD\pm} = \pm 2.5\text{ V}$ , $V_O = 0$ ,	Full range	0.61	3		0.61	3		mV
$\alpha_{VIO}$ Temperature coefficient of input offset voltage			1		1		$\mu\text{V}/^\circ\text{C}$		
Input offset voltage long-term drift (see Note 4)		25°C	0.003		0.003		$\mu\text{V}/\text{mo}$		
$I_{IO}$ Input offset current		25°C	0.5		0.5		pA		
		Full range		150		150			
$I_{IB}$ Input bias current		25°C	1		1		pA		
	Full range		150		150				
$V_{ICR}$ Common-mode input voltage range	$R_S = 50\ \Omega$ , $ V_{IO}  \leq 5\text{ mV}$	25°C	0 to 4	-0.3 to 4.2		0 to 4	-0.3 to 4.2		V
		Full range	0 to 3.5		0 to 3.5				
$V_{OH}$ High-level output voltage	$I_{OH} = -500\ \mu\text{A}$	25°C	4.75	4.88		4.75	4.88		V
	$I_{OH} = -1\text{ mA}$		4.5	4.76		4.5	4.76		
$V_{OL}$ Low-level output voltage	$V_{IC} = 2.5\text{ V}$ , $I_{OL} = 50\ \mu\text{A}$	25°C		12			12		mV
	$V_{IC} = 2.5\text{ V}$ , $I_{OL} = 500\ \mu\text{A}$	25°C		120			120		
		Full range			500			500	
$A_{VD}$ Large-signal differential voltage amplification	$V_{IC} = 2.5\text{ V}$ , $V_O = 1\text{ V to }4\text{ V}$	$R_L = 2\text{ k}\Omega$ ‡	25°C	3	5		3	5	V/mV
		$R_L = 1\text{ M}\Omega$ ‡	Full range	1			1		
			25°C		800			800	
$r_{id}$ Differential input resistance		25°C		$10^{12}$			$10^{12}$	$\Omega$	
$r_{ic}$ Common-mode input resistance		25°C		$10^{12}$			$10^{12}$	$\Omega$	
$c_{ic}$ Common-mode input capacitance	$f = 10\text{ kHz}$	25°C		6			6	pF	
$z_o$ Closed-loop output impedance	$f = 10\text{ kHz}$ , $A_V = 10$	25°C		70			70	$\Omega$	
CMRR Common-mode rejection ratio	$V_{IC} = 0\text{ to }2.7\text{ V}$ , $V_O = 1.5\text{ V}$ , $R_S = 50\ \Omega$	25°C	70	85		70	85	dB	
		Full range	65			65			
$k_{SVR}$ Supply voltage rejection ratio ( $\Delta V_{DD} / \Delta V_{IO}$ )	$V_{DD} = 4.4\text{ V to }8\text{ V}$ , $V_{IC} = V_{DD}/2$ , No load	25°C	80	95		80	95	dB	
		Full range	80			80			
$I_{DD}$ Supply current	$V_O = 2.5\text{ V}$ , No load	25°C	110	150		110	150	$\mu\text{A}$	
		Full range		200			200		

† Full range for the TLV2221C is 0°C to 70°C. Full range for the TLV2221I is -40°C to 85°C.

‡ Referenced to 2.5 V

NOTE 5: Typical values are based on the input offset voltage shift observed through 500 hours of operating life test at  $T_A = 150^\circ\text{C}$  extrapolated to  $T_A = 25^\circ\text{C}$  using the Arrhenius equation and assuming an activation energy of 0.96 eV.

**TLV2221, TLV2221Y**  
**Advanced LinCMOS™ RAIL-TO-RAIL**  
**VERY LOW-POWER SINGLE OPERATIONAL AMPLIFIERS**

SLOS157B – JUNE 1996 – REVISED APRIL 2005

operating characteristics at specified free-air temperature,  $V_{DD} = 5\text{ V}$

PARAMETER	TEST CONDITIONS	$T_A$ †	TLV2221C			TLV2221I			UNIT	
			MIN	TYP	MAX	MIN	TYP	MAX		
SR	Slew rate at unity gain $V_O = 1.5\text{ V to }3.5\text{ V}$ , $R_L = 2\text{ k}\Omega$ ‡, $C_L = 100\text{ pF}$ ‡	25°C	0.1	0.18		0.1	0.18		V/ $\mu$ s	
		Full range	0.05			0.05				
$V_n$	Equivalent input noise voltage $f = 10\text{ Hz}$ $f = 1\text{ kHz}$	25°C	90			90			nV/ $\sqrt{\text{Hz}}$	
		25°C	19			19				
$V_{N(PP)}$	Peak-to-peak equivalent input noise voltage $f = 0.1\text{ Hz to }1\text{ Hz}$ $f = 0.1\text{ Hz to }10\text{ Hz}$	25°C	800			800			nV	
		25°C	960			960				
$I_n$	Equivalent input noise current	25°C	0.6			0.6			fA/ $\sqrt{\text{Hz}}$	
THD+N	Total harmonic distortion plus noise $V_O = 1.5\text{ V to }3.5\text{ V}$ , $f = 20\text{ kHz}$ , $R_L = 2\text{ k}\Omega$ ‡	25°C	$A_V = 1$	2.45%			2.45%			
			$A_V = 10$	5.54%			5.54%			
	25°C	$V_O = 1.5\text{ V to }3.5\text{ V}$ , $f = 20\text{ kHz}$ , $R_L = 2\text{ k}\Omega$ §	$A_V = 1$	0.142%			0.142%			
			$A_V = 10$	0.257%			0.257%			
	Gain-bandwidth product $f = 1\text{ kHz}$ , $C_L = 100\text{ pF}$ ‡	25°C	510			510			kHz	
$B_{OM}$	Maximum output-swing bandwidth $V_{O(PP)} = 1\text{ V}$ , $R_L = 2\text{ k}\Omega$ ‡, $A_V = 1$ , $C_L = 100\text{ pF}$ ‡	25°C	40			40			kHz	
$t_s$	Settling time $A_V = -1$ , Step = 1.5 V to 3.5 V, $R_L = 2\text{ k}\Omega$ ‡, $C_L = 100\text{ pF}$ ‡	25°C	6.8			6.8			$\mu$ s	
		25°C	9.2			9.2				
$\phi_m$	Phase margin at unity gain $R_L = 2\text{ k}\Omega$ ‡, $C_L = 100\text{ pF}$ ‡	25°C	52°			52°				
		25°C	12			12			dB	

† Full range is  $-40^\circ\text{C}$  to  $85^\circ\text{C}$ .

‡ Referenced to 2.5 V

§ Referenced to 0 V



**TLV2221, TLV2221Y**  
**Advanced LinCMOS™ RAIL-TO-RAIL**  
**VERY LOW-POWER SINGLE OPERATIONAL AMPLIFIERS**

SLOS157B – JUNE 1996 – REVISED APRIL 2005

**electrical characteristics at  $V_{DD} = 3\text{ V}$ ,  $T_A = 25^\circ\text{C}$  (unless otherwise noted)**

PARAMETER	TEST CONDITIONS	TLV2221Y			UNIT
		MIN	TYP	MAX	
$V_{IO}$ Input offset voltage	$V_{DD} \pm = \pm 1.5\text{ V}$ , $R_S = 50\ \Omega$	620			$\mu\text{V}$
$I_{IO}$ Input offset current		0.5			$\text{pA}$
$I_{IB}$ Input bias current		1			$\text{pA}$
$V_{ICR}$ Common-mode input voltage range	$ V_{IO}  \leq 5\text{ mV}$ , $R_S = 50\ \Omega$	-0.3 to 2.2			$\text{V}$
$V_{OH}$ High-level output voltage	$I_{OH} = -100\ \mu\text{A}$	2.97			$\text{V}$
$V_{OL}$ Low-level output voltage	$V_{IC} = 1.5\text{ V}$ , $I_{OL} = 50\ \mu\text{A}$	15			$\text{mV}$
	$V_{IC} = 1.5\text{ V}$ , $I_{OL} = 500\ \mu\text{A}$	150			
$A_{VD}$ Large-signal differential voltage amplification	$V_O = 1\text{ V to } 2\text{ V}$	$R_L = 2\text{ k}\Omega^\dagger$	3		$\text{V/mV}$
		$R_L = 1\text{ M}\Omega^\dagger$	250		
$r_{id}$ Differential input resistance		$10^{12}$			$\Omega$
$r_{ic}$ Common-mode input resistance		$10^{12}$			$\Omega$
$c_{ic}$ Common-mode input capacitance	$f = 10\text{ kHz}$	6			$\text{pF}$
$z_o$ Closed-loop output impedance	$f = 10\text{ kHz}$ , $A_V = 10$	90			$\Omega$
CMRR Common-mode rejection ratio	$V_{IC} = 0\text{ to } 1.7\text{ V}$ , $V_O = 0$ , $R_S = 50\ \Omega$	82			$\text{dB}$
$k_{SVR}$ Supply voltage rejection ratio ( $\Delta V_{DD}/\Delta V_{IO}$ )	$V_{DD} = 2.7\text{ V to } 8\text{ V}$ , $V_{IC} = 0$ , No load	95			$\text{dB}$
$I_{DD}$ Supply current	$V_O = 0$ , No load	100			$\mu\text{A}$

$^\dagger$  Referenced to 1.5 V

**electrical characteristics at  $V_{DD} = 5\text{ V}$ ,  $T_A = 25^\circ\text{C}$  (unless otherwise noted)**

PARAMETER	TEST CONDITIONS	TLV2221Y			UNIT
		MIN	TYP	MAX	
$V_{IO}$ Input offset voltage	$V_{DD} \pm = \pm 1.5\text{ V}$ , $R_S = 50\ \Omega$	610			$\mu\text{V}$
$I_{IO}$ Input offset current		0.5			$\text{pA}$
$I_{IB}$ Input bias current		1			$\text{pA}$
$V_{ICR}$ Common-mode input voltage range	$ V_{IO}  \leq 5\text{ mV}$ , $R_S = 50\ \Omega$	-0.3 to 4.2			$\text{V}$
$V_{OH}$ High-level output voltage	$I_{OH} = -500\ \mu\text{A}$	4.88			$\text{V}$
$V_{OL}$ Low-level output voltage	$V_{IC} = 2.5\text{ V}$ , $I_{OL} = 50\ \mu\text{A}$	12			$\text{mV}$
	$V_{IC} = 2.5\text{ V}$ , $I_{OL} = 500\ \mu\text{A}$	120			
$A_{VD}$ Large-signal differential voltage amplification	$V_O = 1\text{ V to } 4\text{ V}$	$R_L = 2\text{ k}\Omega^\dagger$	5		$\text{V/mV}$
		$R_L = 1\text{ M}\Omega^\dagger$	800		
$r_{id}$ Differential input resistance		$10^{12}$			$\Omega$
$r_{ic}$ Common-mode input resistance		$10^{12}$			$\Omega$
$c_{ic}$ Common-mode input capacitance	$f = 10\text{ kHz}$	6			$\text{pF}$
$z_o$ Closed-loop output impedance	$f = 10\text{ kHz}$ , $A_V = 10$	70			$\Omega$
CMRR Common-mode rejection ratio	$V_{IC} = 0\text{ to } 1.7\text{ V}$ , $V_O = 0$ , $R_S = 50\ \Omega$	85			$\text{dB}$
$k_{SVR}$ Supply voltage rejection ratio ( $\Delta V_{DD}/\Delta V_{IO}$ )	$V_{DD} = 2.7\text{ V to } 8\text{ V}$ , $V_{IC} = 0$ , No load	95			$\text{dB}$
$I_{DD}$ Supply current	$V_O = 0$ , No load	110			$\mu\text{A}$

$^\dagger$  Referenced to 2.5 V

**TLV2221, TLV2221Y**  
**Advanced LinCMOS™ RAIL-TO-RAIL**  
**VERY LOW-POWER SINGLE OPERATIONAL AMPLIFIERS**

SLOS157B – JUNE 1996 – REVISED APRIL 2005

**TYPICAL CHARACTERISTICS**

**Table of Graphs**

		<b>FIGURE</b>
$V_{IO}$	Input offset voltage	Distribution vs Common-mode input voltage 2, 3 4, 5
$\alpha V_{IO}$	Input offset voltage temperature coefficient	Distribution 6, 7
$I_{IB}/I_{IO}$	Input bias and input offset currents	vs Free-air temperature 8
$V_I$	Input voltage	vs Supply voltage vs Free-air temperature 9 10
$V_{OH}$	High-level output voltage	vs High-level output current 11, 14
$V_{OL}$	Low-level output voltage	vs Low-level output current 12, 13, 15
$V_{O(PP)}$	Maximum peak-to-peak output voltage	vs Frequency 16
$I_{OS}$	Short-circuit output current	vs Supply voltage vs Free-air temperature 17 18
$V_O$	Output voltage	vs Differential input voltage 19, 20
$A_{VD}$	Differential voltage amplification	vs Load resistance 21
$A_{VD}$	Large signal differential voltage amplification	vs Frequency vs Free-air temperature 22, 23 24, 25
$z_o$	Output impedance	vs Frequency 26, 27
CMRR	Common-mode rejection ratio	vs Frequency vs Free-air temperature 28 29
$k_{SVR}$	Supply-voltage rejection ratio	vs Frequency vs Free-air temperature 30, 31 32
$I_{DD}$	Supply current	vs Supply voltage 33
SR	Slew rate	vs Load capacitance vs Free-air temperature 34 35
$V_O$	Inverting large-signal pulse response	vs Time 36, 37
$V_O$	Voltage-follower large-signal pulse response	vs Time 38, 39
$V_O$	Inverting small-signal pulse response	vs Time 40, 41
$V_O$	Voltage-follower small-signal pulse response	vs Time 42, 43
$V_n$	Equivalent input noise voltage	vs Frequency 44, 45
	Input noise voltage (referred to input)	Over a 10-second period 46
THD + N	Total harmonic distortion plus noise	vs Frequency 47
	Gain-bandwidth product	vs Free-air temperature vs Supply voltage 48 49
$\phi_m$	Phase margin	vs Frequency vs Load capacitance 22, 23 52, 53
	Gain margin	vs Load capacitance 50, 51
$B_1$	Unity-gain bandwidth	vs Load capacitance 54, 55

**TYPICAL CHARACTERISTICS**

**DISTRIBUTION OF TLV2211  
 INPUT OFFSET VOLTAGE**

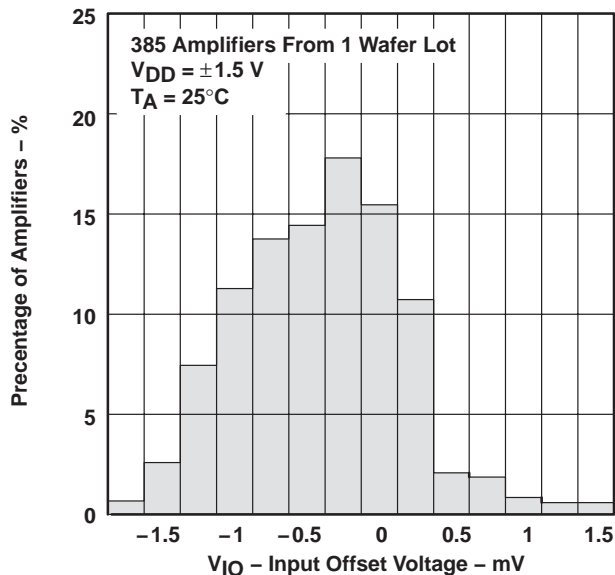

**Figure 2**

**DISTRIBUTION OF TLV2211  
 INPUT OFFSET VOLTAGE**

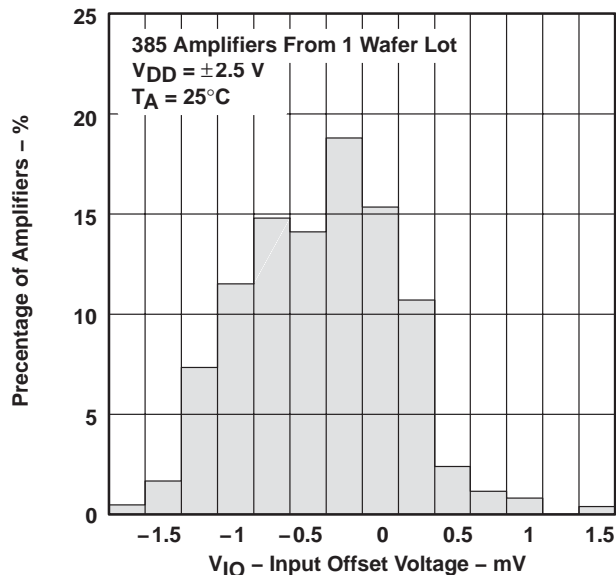

**Figure 3**

**INPUT OFFSET VOLTAGE†  
 vs  
 COMMON-MODE INPUT VOLTAGE**

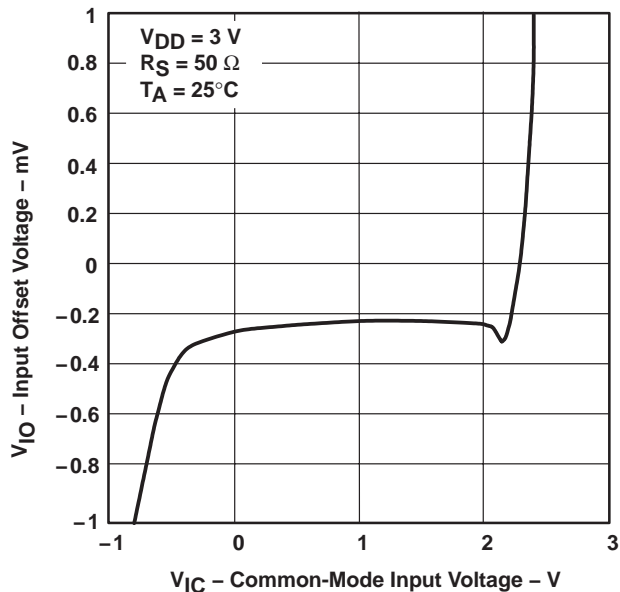

**Figure 4**

**INPUT OFFSET VOLTAGE†  
 vs  
 COMMON-MODE INPUT VOLTAGE**

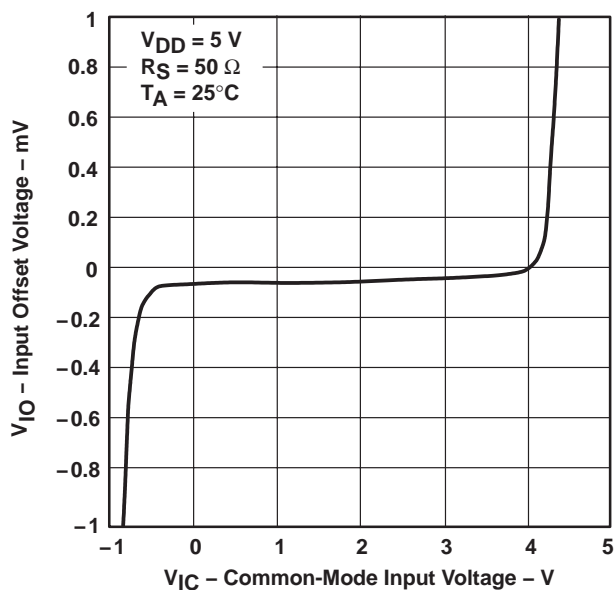

**Figure 5**

† For all curves where  $V_{DD} = 5\text{ V}$ , all loads are referenced to 2.5 V. For all curves where  $V_{DD} = 3\text{ V}$ , all loads are referenced to 1.5 V.

**TLV2221, TLV2221Y**  
**Advanced LinCMOS™ RAIL-TO-RAIL**  
**VERY LOW-POWER SINGLE OPERATIONAL AMPLIFIERS**

SLOS157B – JUNE 1996 – REVISED APRIL 2005

**TYPICAL CHARACTERISTICS**

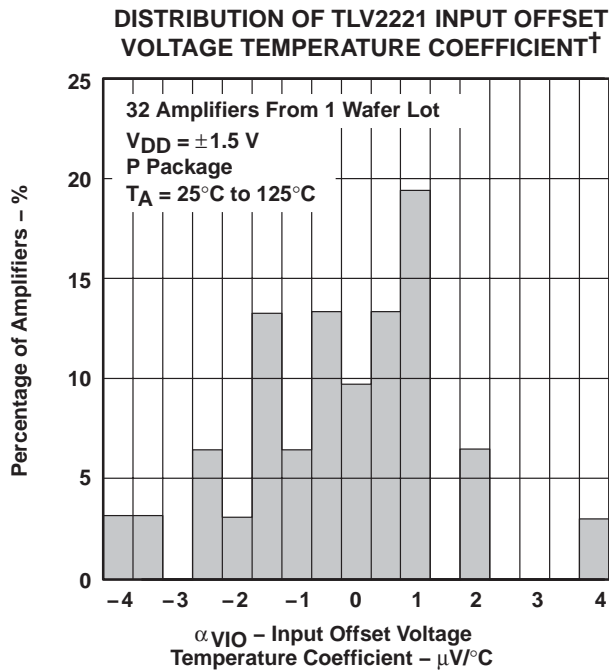

**Figure 6**

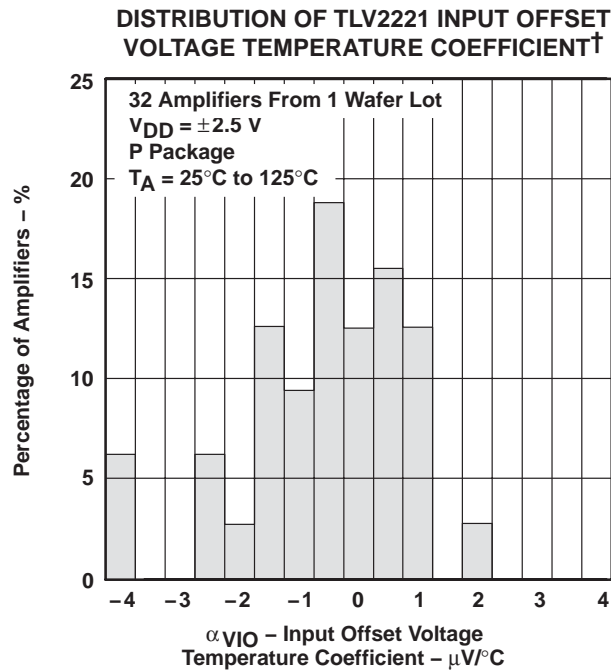

**Figure 7**

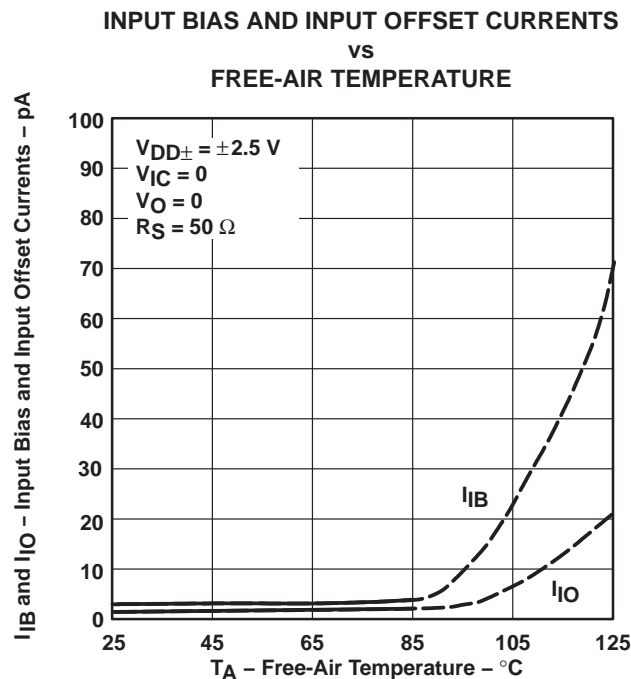

**Figure 8**

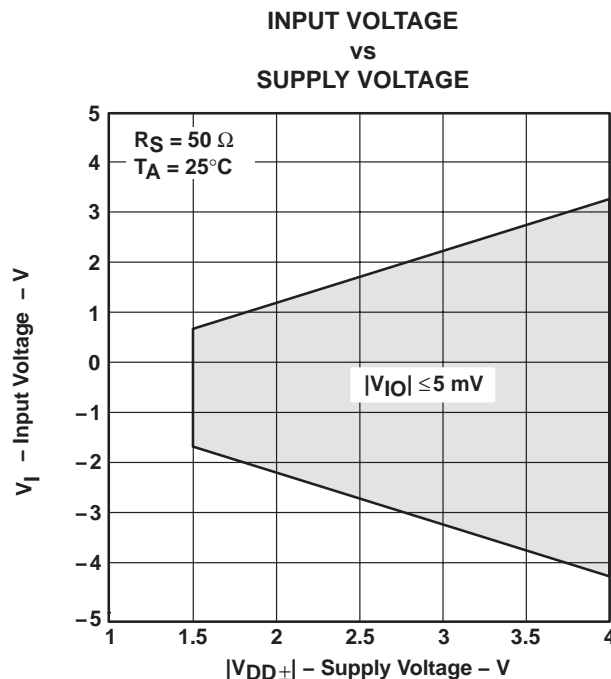

**Figure 9**

† Data at high and low temperatures are applicable only within the rated operating free-air temperature ranges of the various devices.

**TYPICAL CHARACTERISTICS**

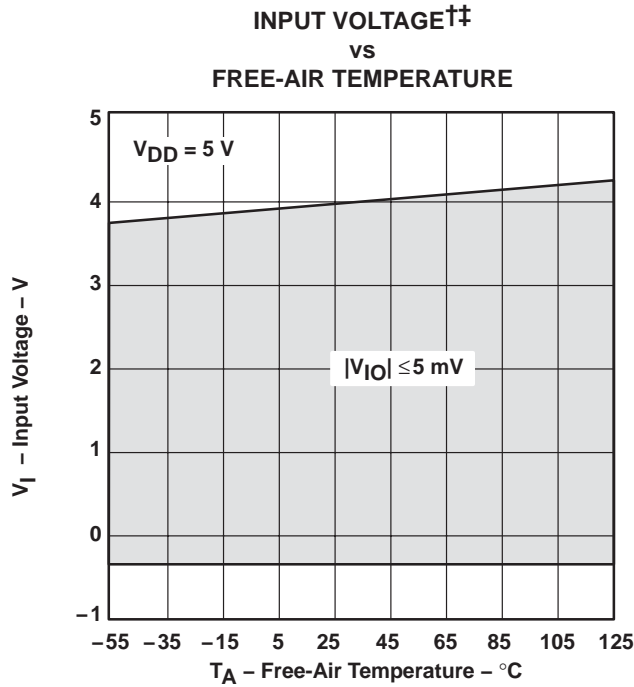

**Figure 10**

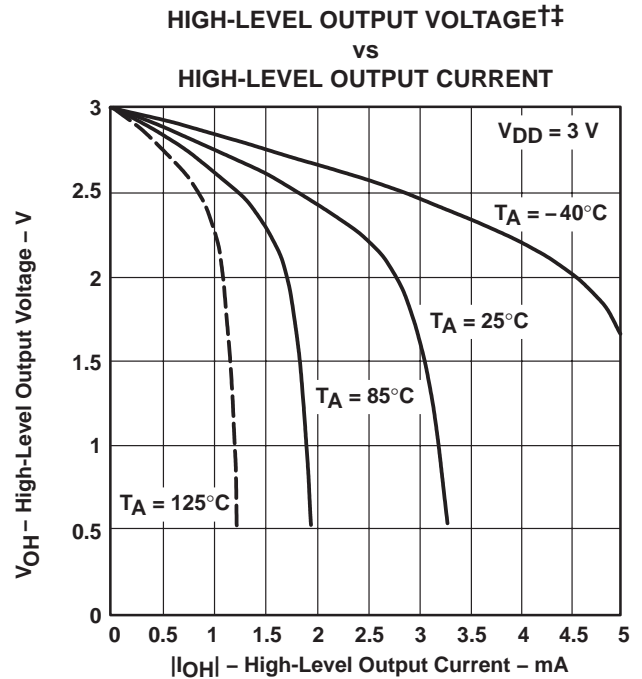

**Figure 11**

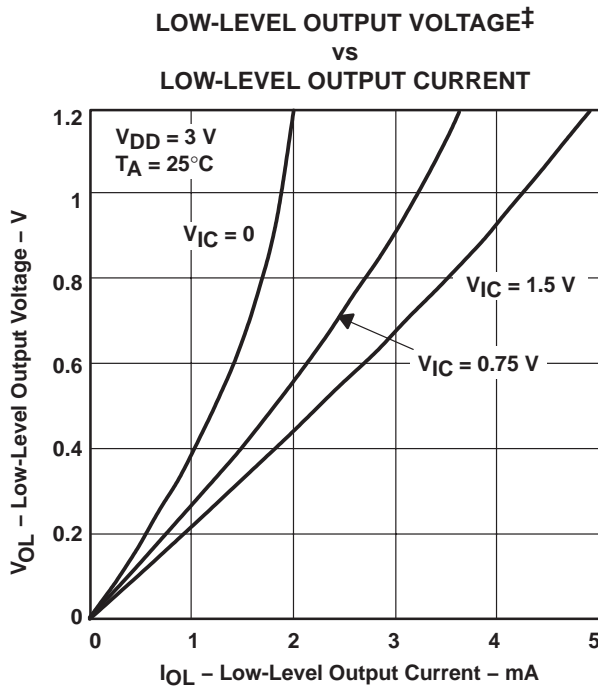

**Figure 12**

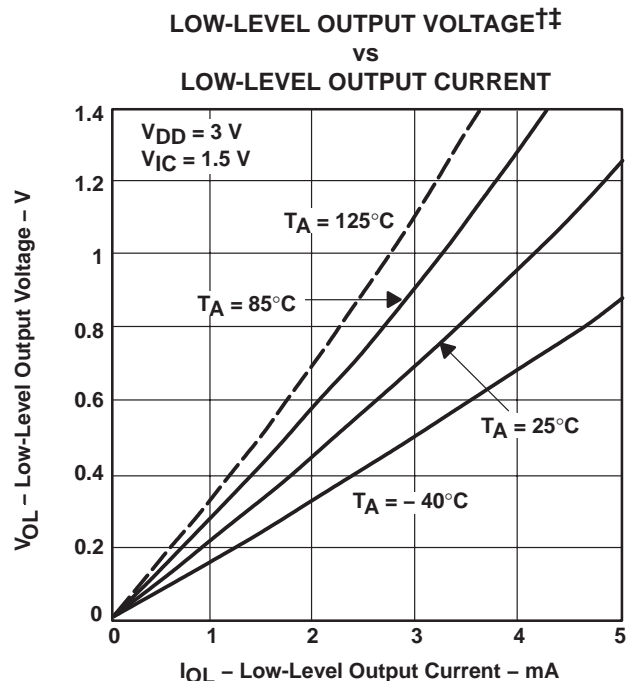

**Figure 13**

† Data at high and low temperatures are applicable only within the rated operating free-air temperature ranges of the various devices.  
 †† For all curves where  $V_{DD} = 5\text{ V}$ , all loads are referenced to 2.5 V. For all curves where  $V_{DD} = 3\text{ V}$ , all loads are referenced to 1.5 V.

**TYPICAL CHARACTERISTICS**

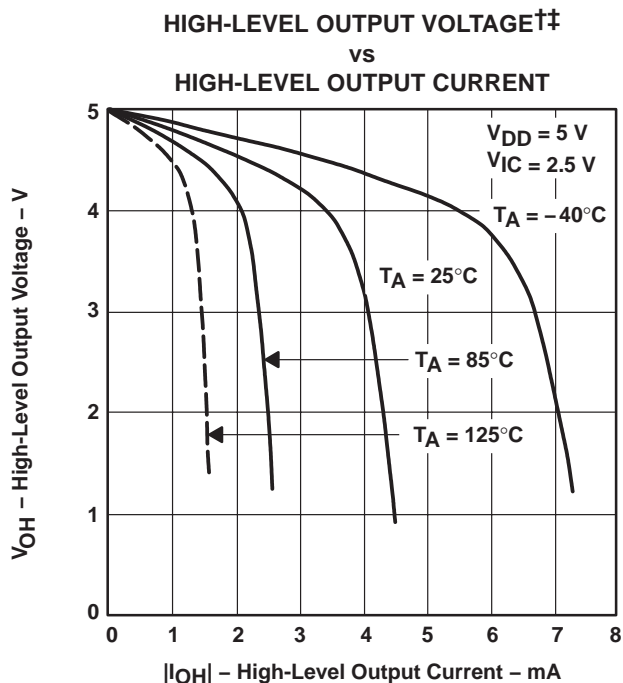

**Figure 14**

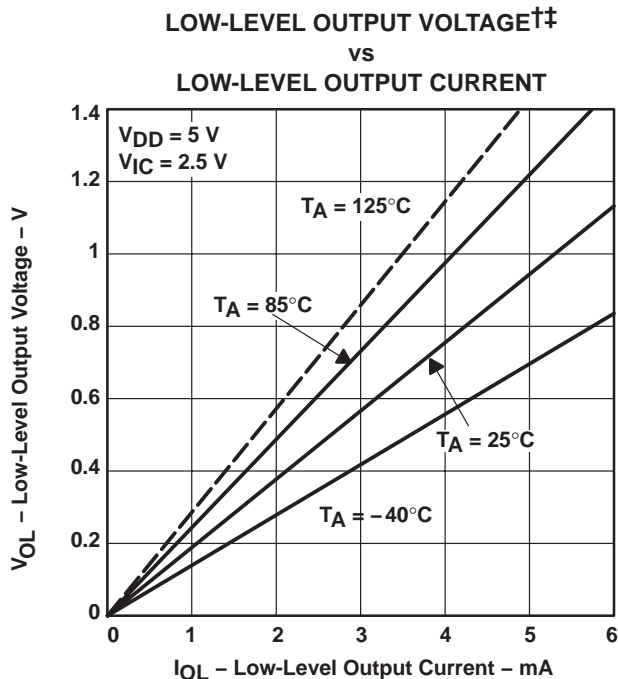

**Figure 15**

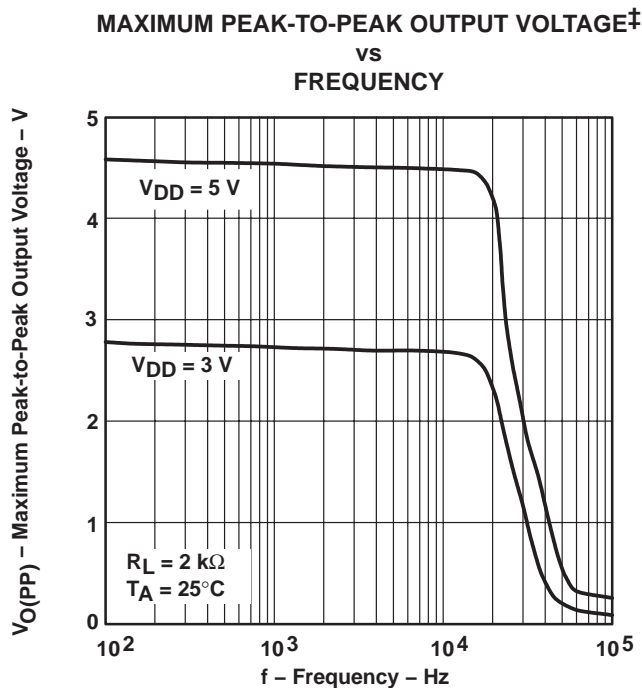

**Figure 16**

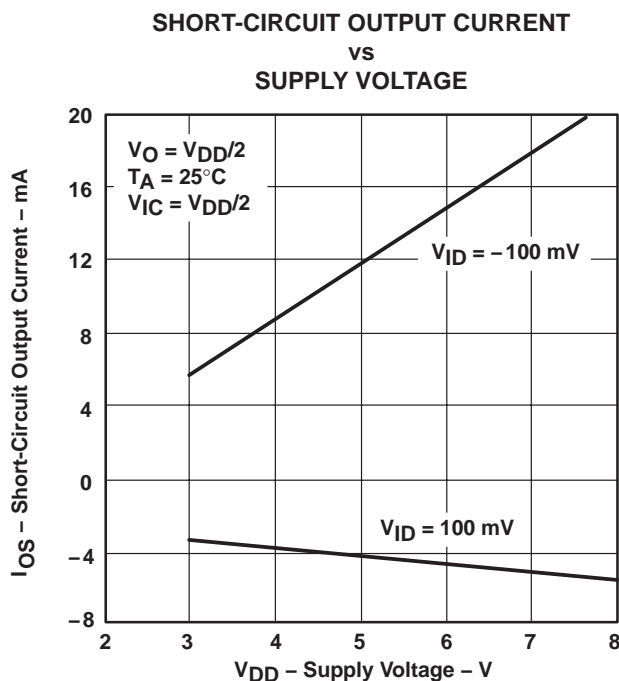

**Figure 17**

† Data at high and low temperatures are applicable only within the rated operating free-air temperature ranges of the various devices.  
 ‡ For all curves where  $V_{DD} = 5\text{ V}$ , all loads are referenced to 2.5 V. For all curves where  $V_{DD} = 3\text{ V}$ , all loads are referenced to 1.5 V.

**TYPICAL CHARACTERISTICS**

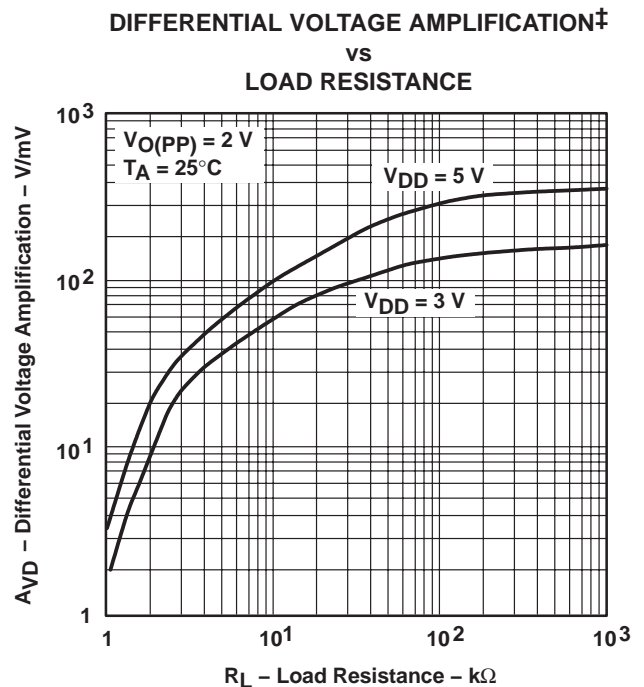
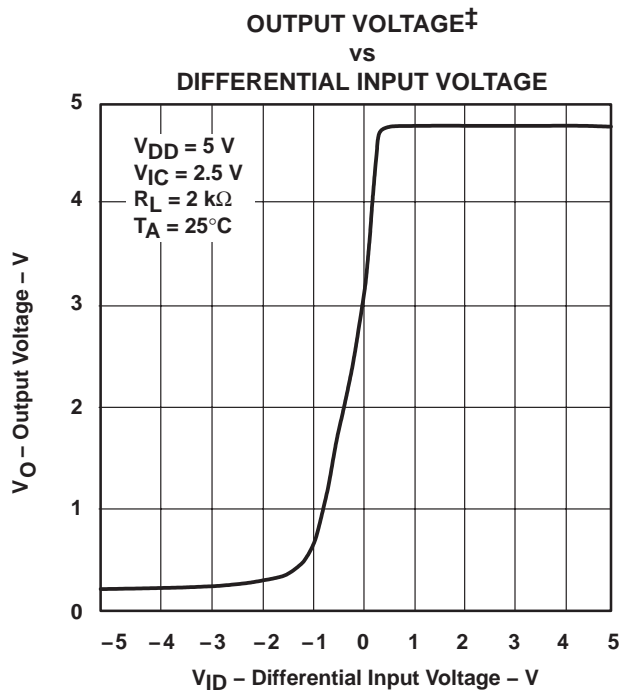
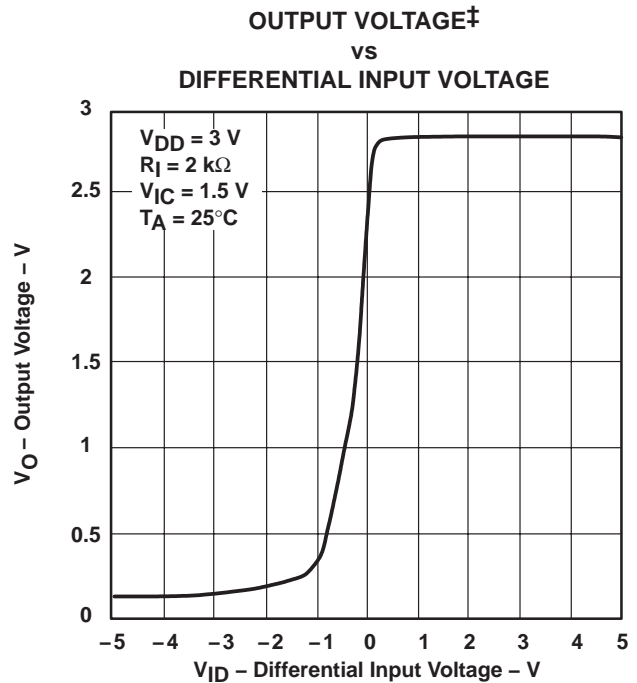
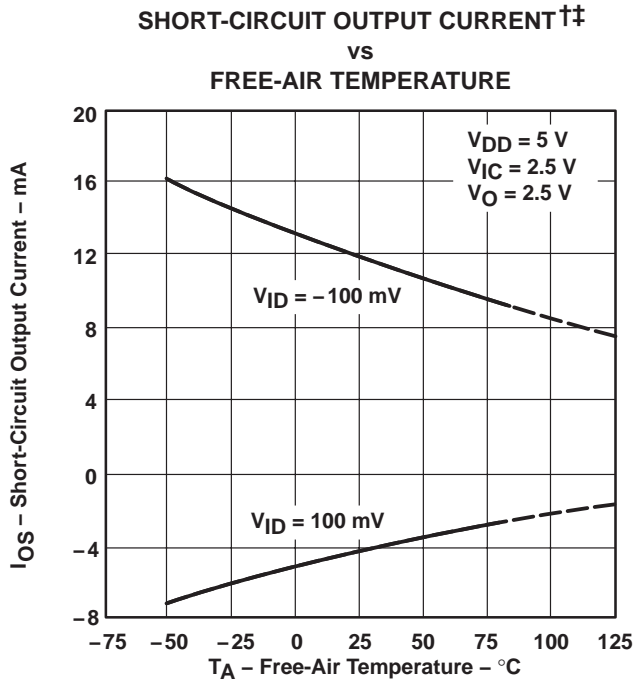

† Data at high and low temperatures are applicable only within the rated operating free-air temperature ranges of the various devices.

‡ For all curves where  $V_{DD} = 5\text{ V}$ , all loads are referenced to 2.5 V. For all curves where  $V_{DD} = 3\text{ V}$ , all loads are referenced to 1.5 V.

**TYPICAL CHARACTERISTICS**

**LARGE-SIGNAL DIFFERENTIAL VOLTAGE†  
 AMPLIFICATION AND PHASE MARGIN†  
 vs  
 FREQUENCY**

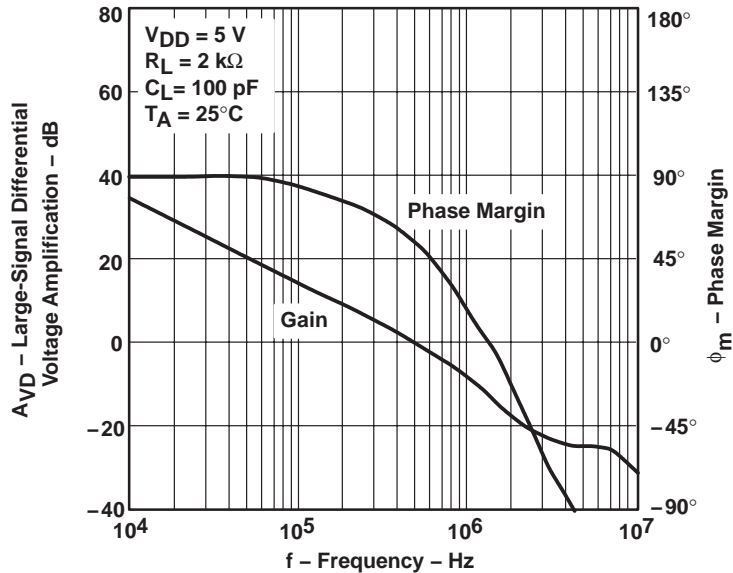

**Figure 22**

**LARGE-SIGNAL DIFFERENTIAL VOLTAGE  
 AMPLIFICATION AND PHASE MARGIN†  
 vs  
 FREQUENCY**

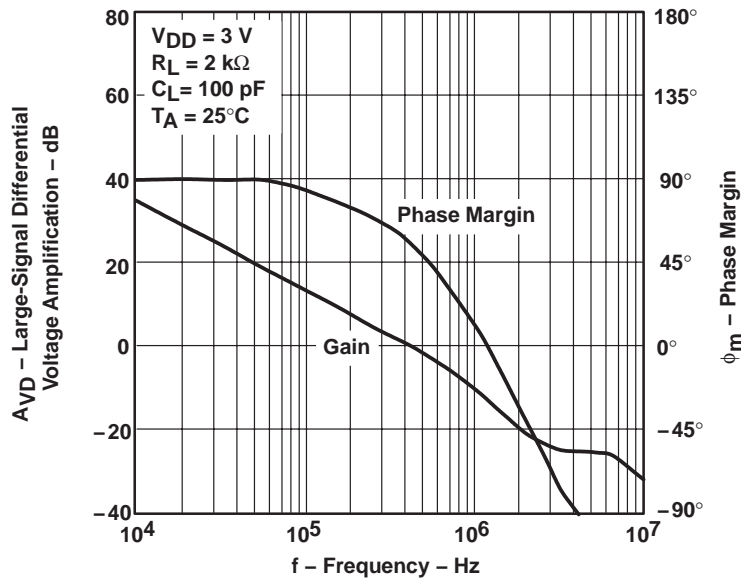

**Figure 23**

† For all curves where  $V_{DD} = 5\text{ V}$ , all loads are referenced to 2.5 V. For all curves where  $V_{DD} = 3\text{ V}$ , all loads are referenced to 1.5 V.



**TYPICAL CHARACTERISTICS**

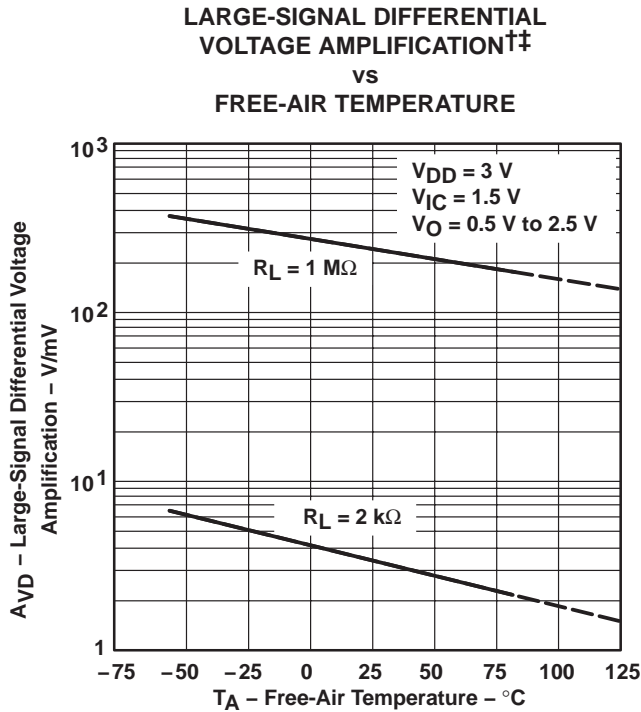

Figure 24

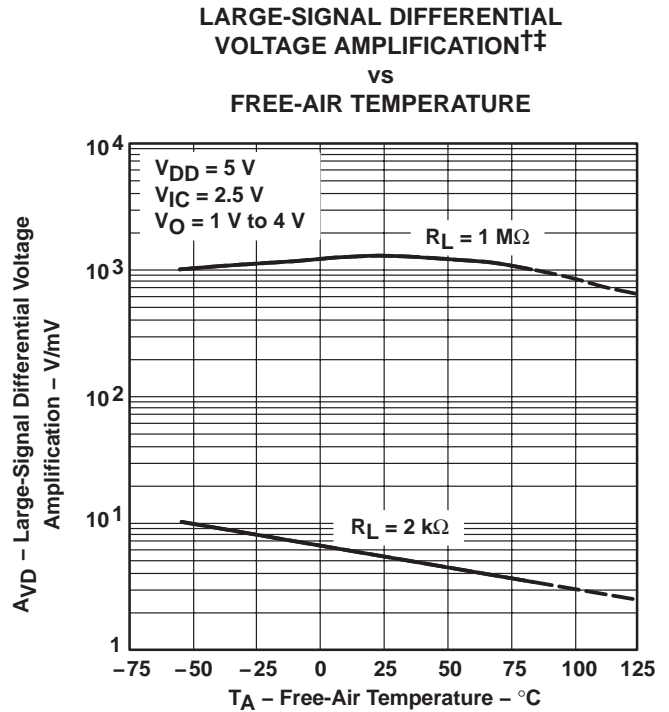

Figure 25

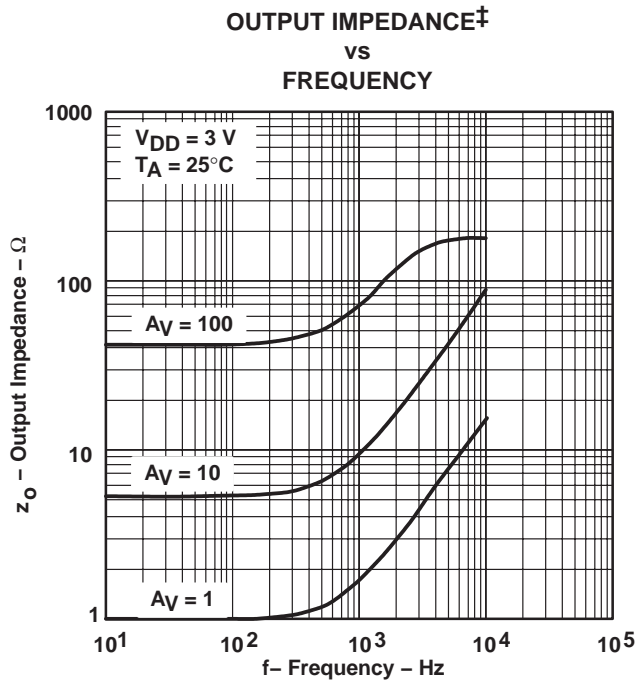

Figure 26

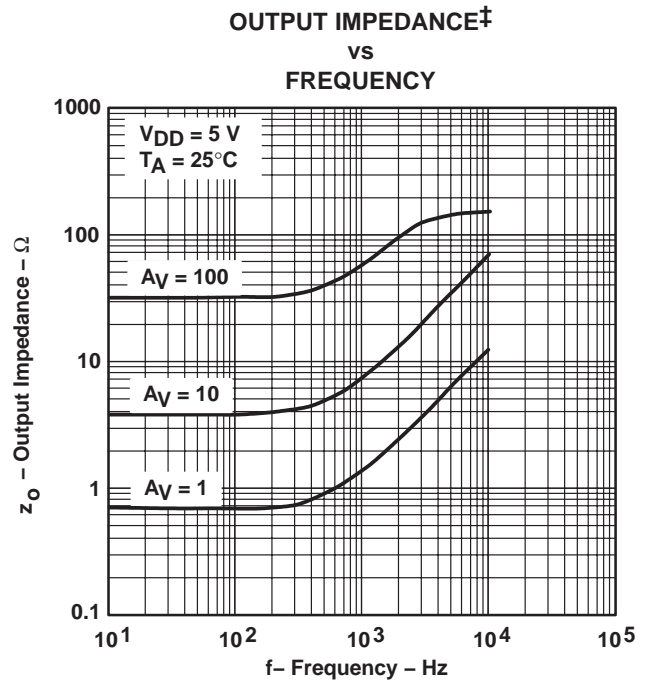
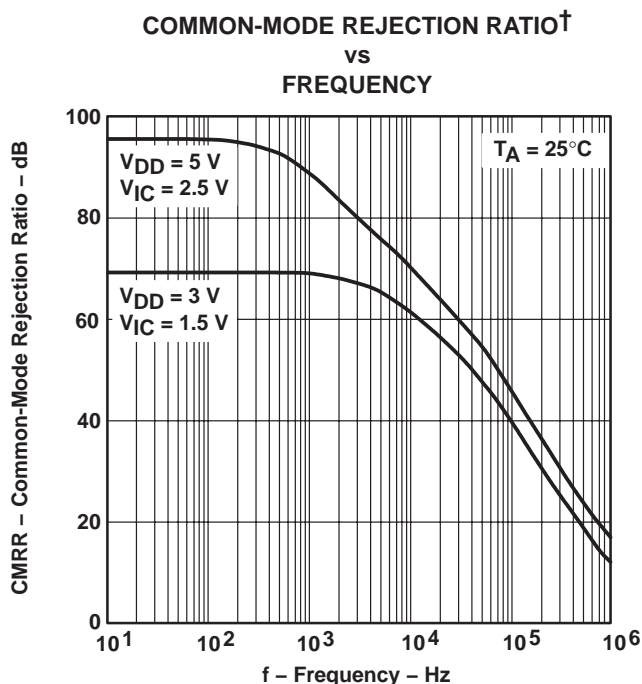

Figure 27

† Data at high and low temperatures are applicable only within the rated operating free-air temperature ranges of the various devices.  
 ‡ For all curves where  $V_{DD} = 5\text{ V}$ , all loads are referenced to 2.5 V. For all curves where  $V_{DD} = 3\text{ V}$ , all loads are referenced to 1.5 V.

**TYPICAL CHARACTERISTICS**



**Figure 28**

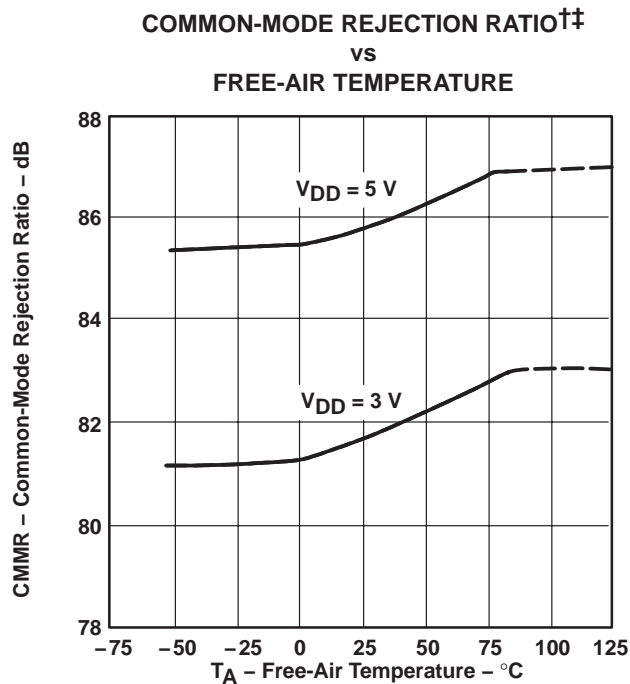

**Figure 29**

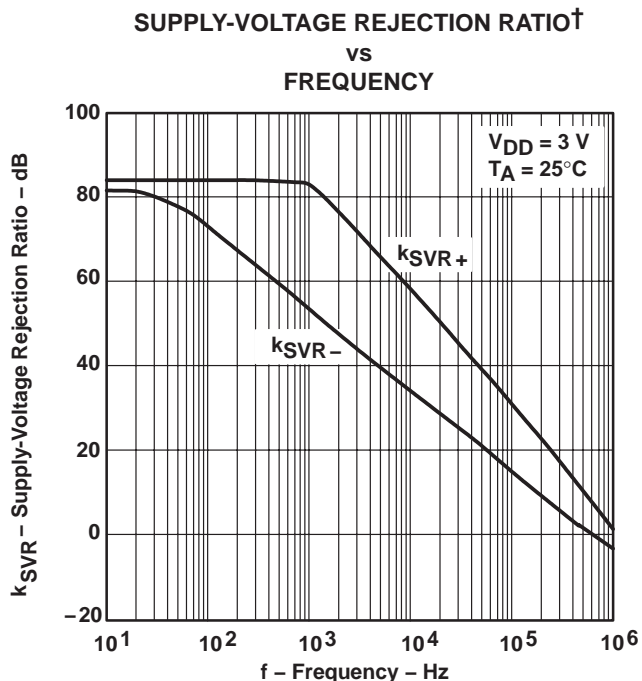

**Figure 30**

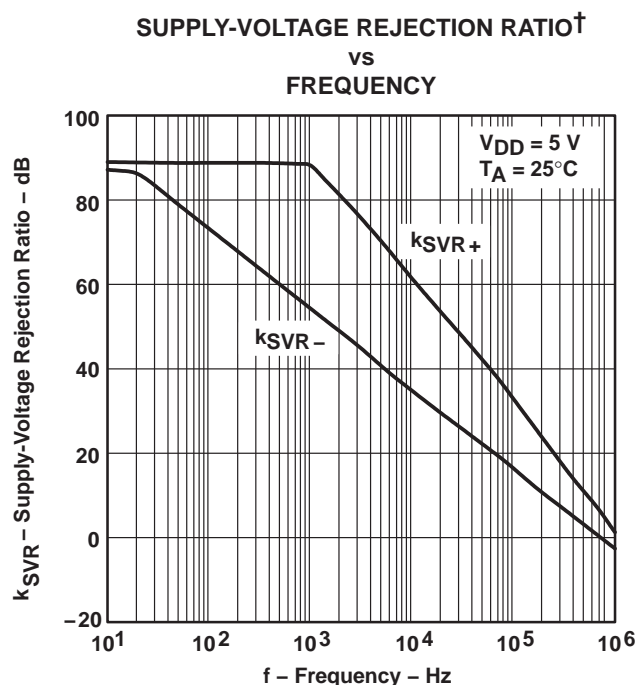

**Figure 31**

† For all curves where  $V_{DD} = 5\text{ V}$ , all loads are referenced to 2.5 V. For all curves where  $V_{DD} = 3\text{ V}$ , all loads are referenced to 1.5 V.  
 ‡ Data at high and low temperatures are applicable only within the rated operating free-air temperature ranges of the various devices.

**TYPICAL CHARACTERISTICS**

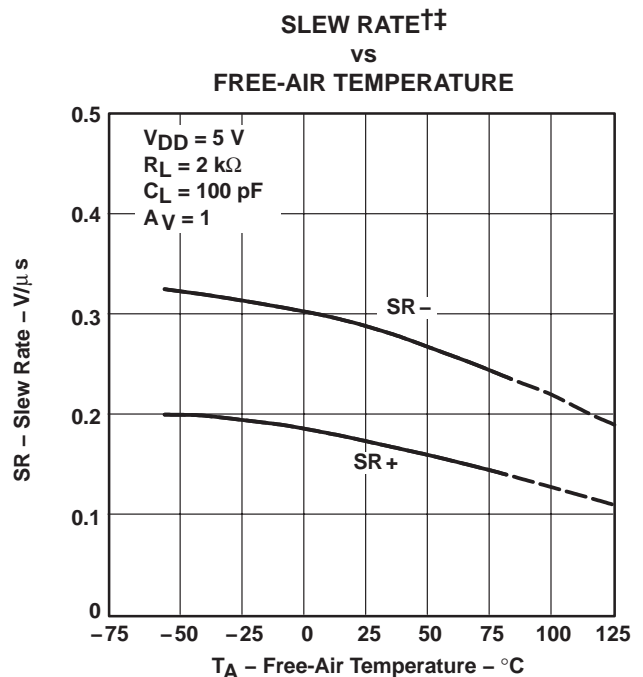
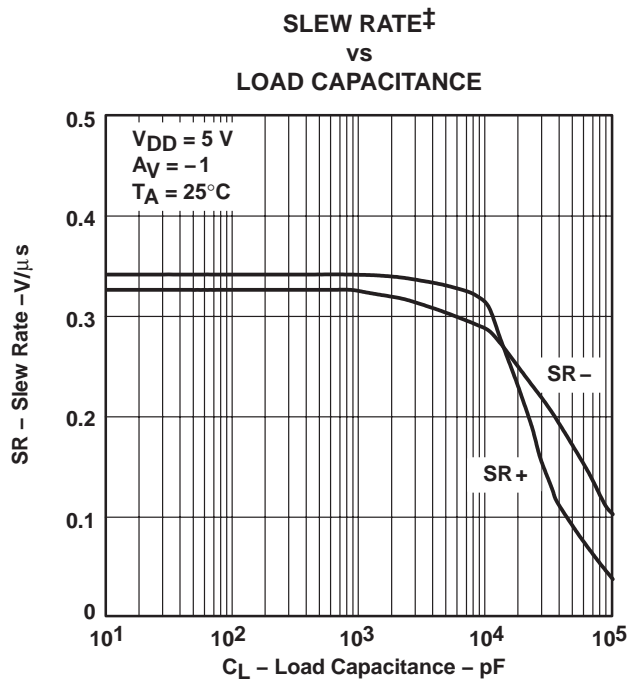
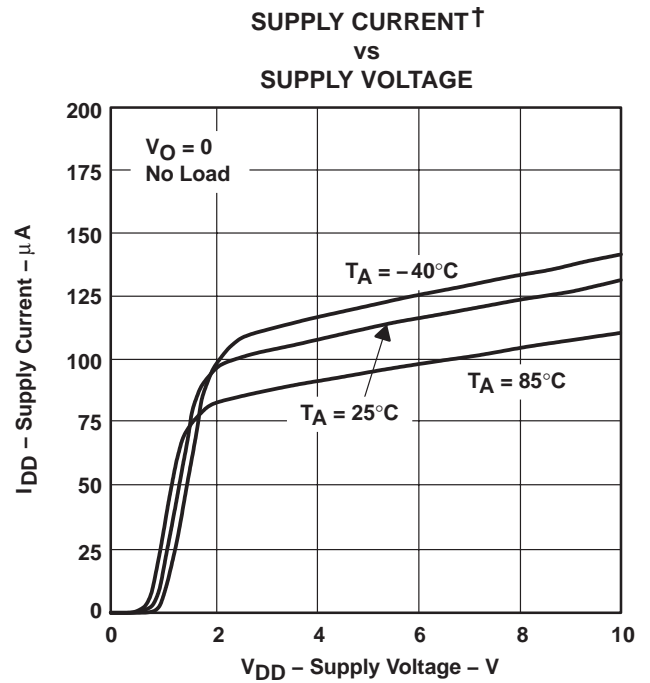
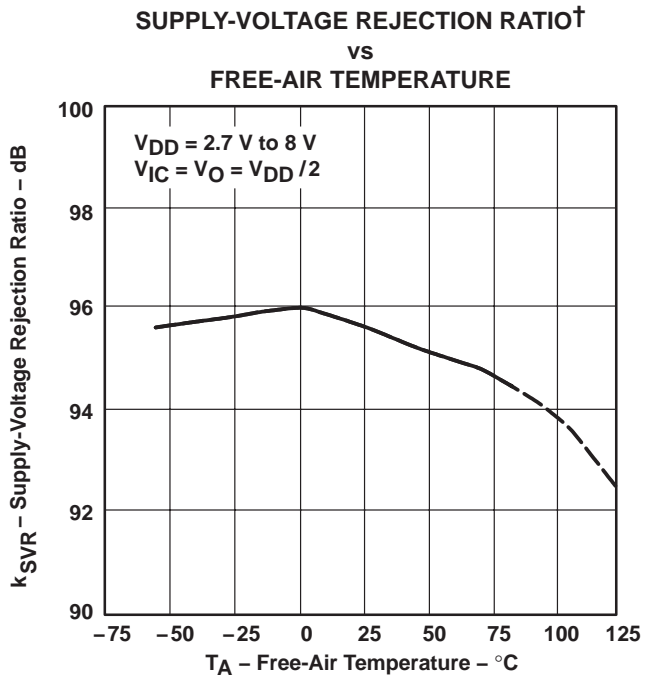

† Data at high and low temperatures are applicable only within the rated operating free-air temperature ranges of the various devices.

‡ For all curves where  $V_{DD} = 5\text{ V}$ , all loads are referenced to 2.5 V. For all curves where  $V_{DD} = 3\text{ V}$ , all loads are referenced to 1.5 V.

**TYPICAL CHARACTERISTICS**

**INVERTING LARGE-SIGNAL PULSE RESPONSE†**

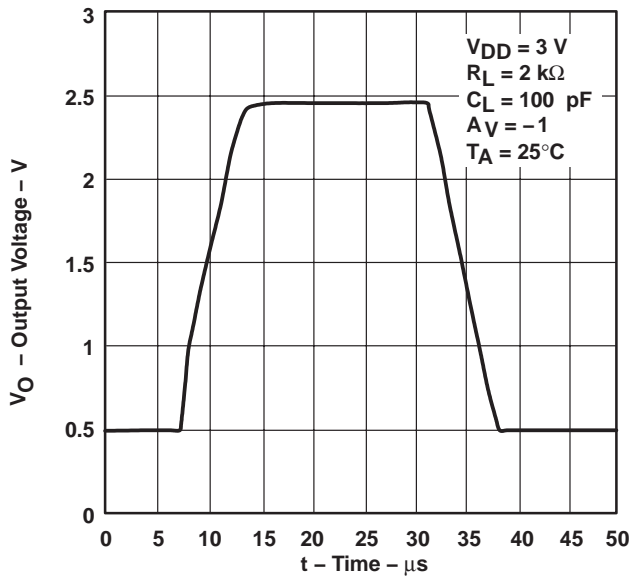

**Figure 36**

**INVERTING LARGE-SIGNAL PULSE RESPONSE†**

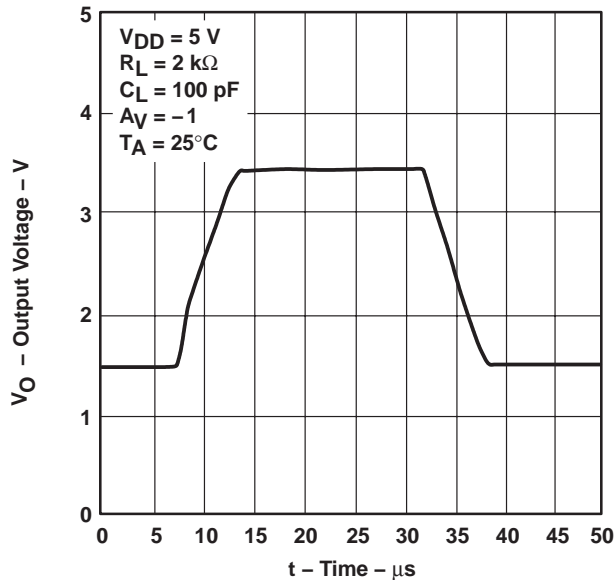

**Figure 37**

**VOLTAGE-FOLLOWER LARGE-SIGNAL PULSE RESPONSE†**

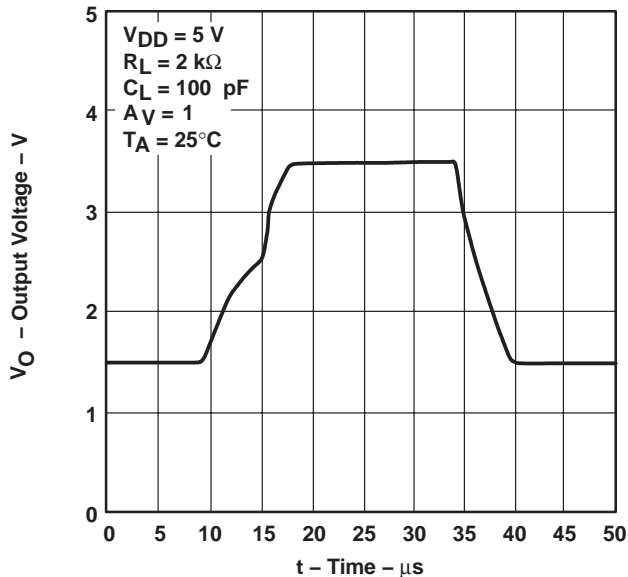

**Figure 38**

**VOLTAGE-FOLLOWER LARGE-SIGNAL PULSE RESPONSE†**

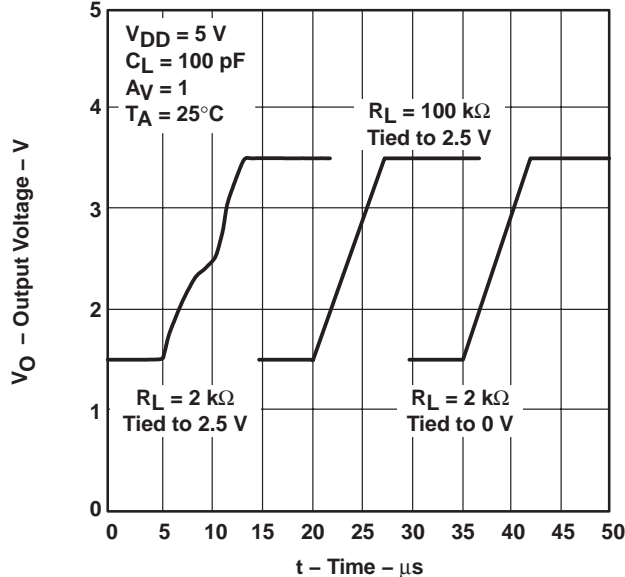
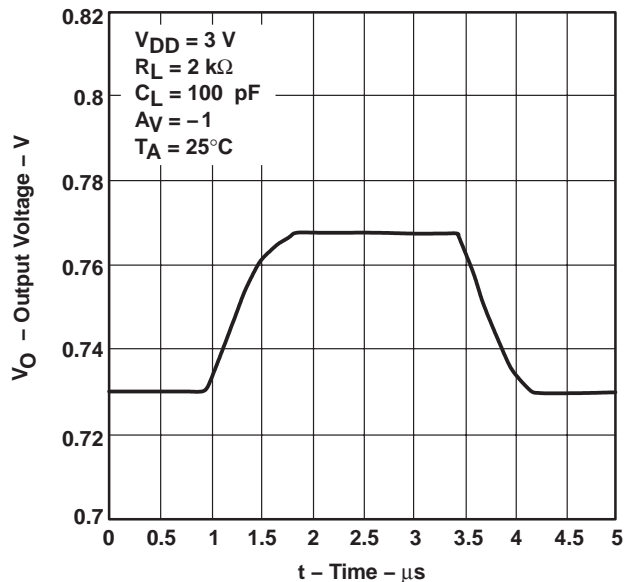

**Figure 39**

† For all curves where  $V_{DD} = 5\text{ V}$ , all loads are referenced to 2.5 V. For all curves where  $V_{DD} = 3\text{ V}$ , all loads are referenced to 1.5 V.

**TYPICAL CHARACTERISTICS**

**INVERTING SMALL-SIGNAL PULSE RESPONSE†**



**Figure 40**

**INVERTING SMALL-SIGNAL PULSE RESPONSE†**

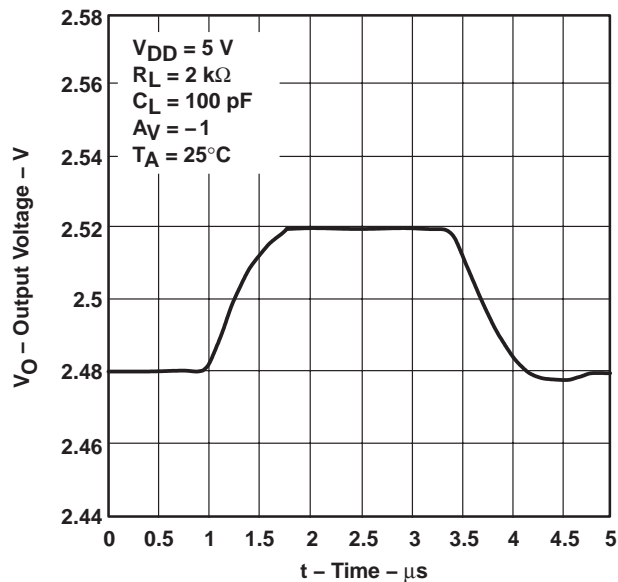

**Figure 41**

**VOLTAGE-FOLLOWER SMALL-SIGNAL PULSE RESPONSE†**

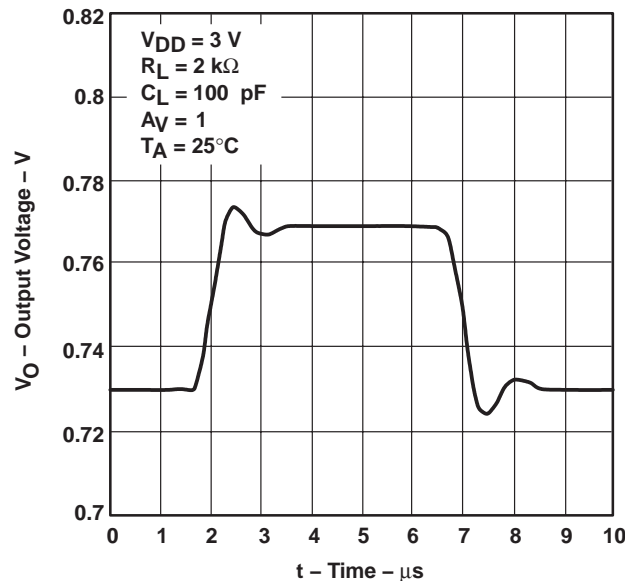

**Figure 42**

**VOLTAGE-FOLLOWER SMALL-SIGNAL PULSE RESPONSE†**

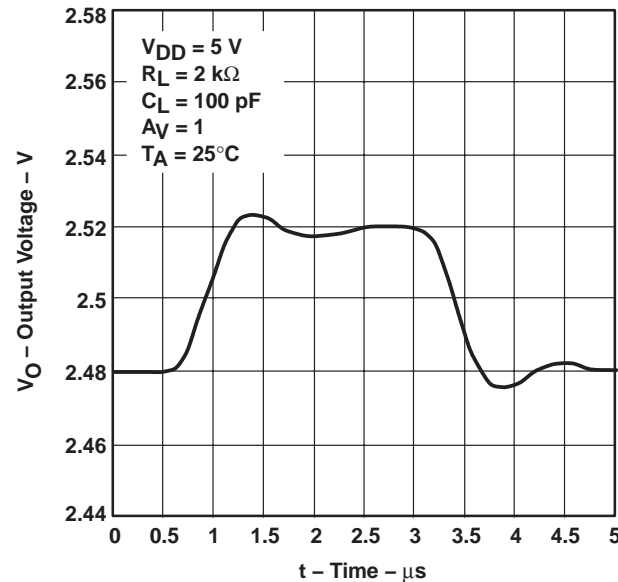
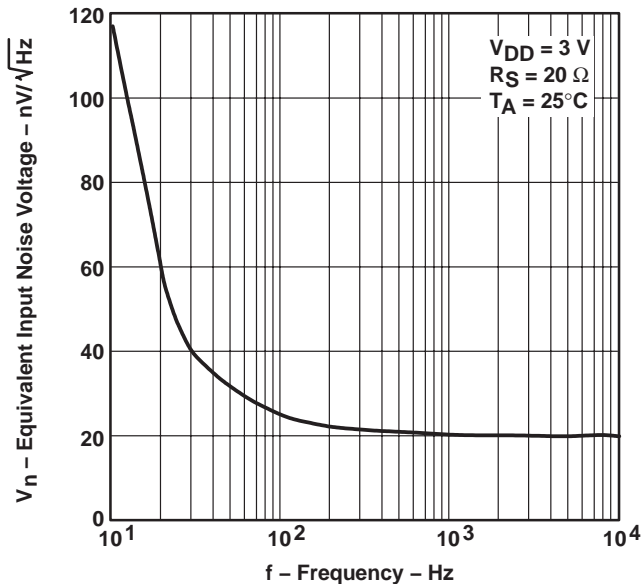

**Figure 43**

† For all curves where  $V_{DD} = 5\text{ V}$ , all loads are referenced to 2.5 V. For all curves where  $V_{DD} = 3\text{ V}$ , all loads are referenced to 1.5 V.

**TYPICAL CHARACTERISTICS**

**EQUIVALENT INPUT NOISE VOLTAGE†  
 VS  
 FREQUENCY**



**Figure 44**

**EQUIVALENT INPUT NOISE VOLTAGE†  
 VS  
 FREQUENCY**

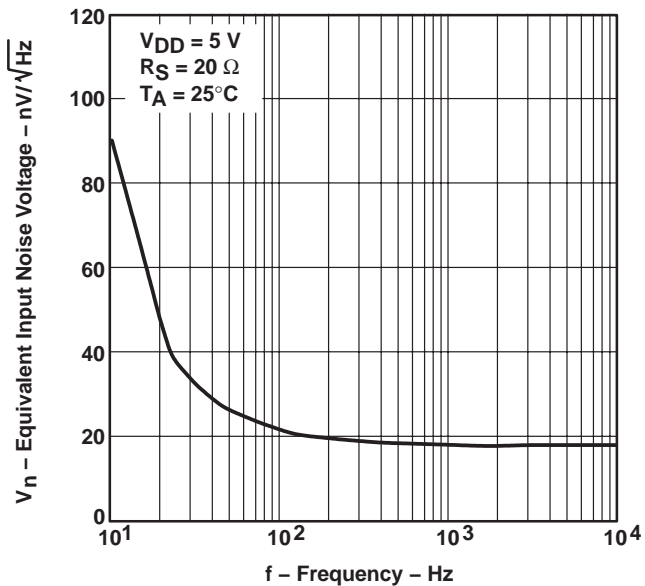

**Figure 45**

**INPUT NOISE VOLTAGE OVER  
 A 10-SECOND PERIOD†**

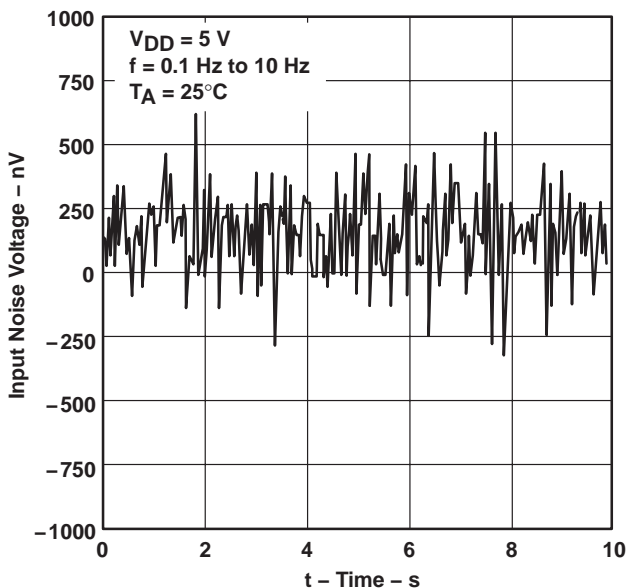

**Figure 46**

**TOTAL HARMONIC DISTORTION PLUS NOISE†  
 VS  
 FREQUENCY**

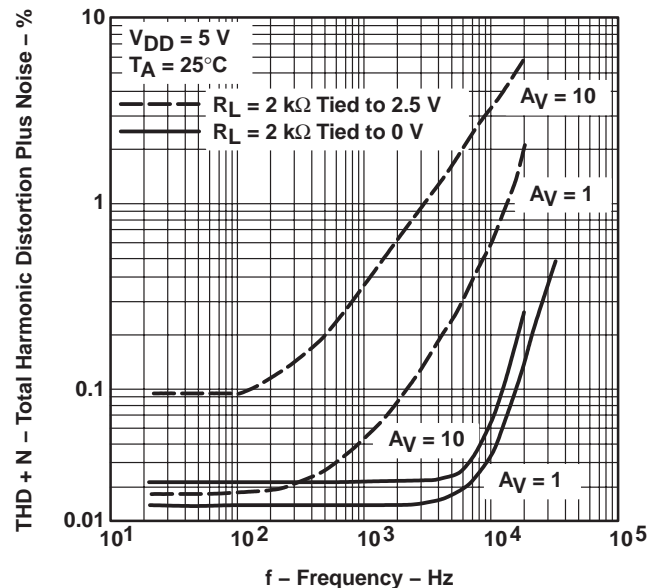

**Figure 47**

† For all curves where  $V_{DD} = 5\text{ V}$ , all loads are referenced to 2.5 V. For all curves where  $V_{DD} = 3\text{ V}$ , all loads are referenced to 1.5 V.

**TYPICAL CHARACTERISTICS**

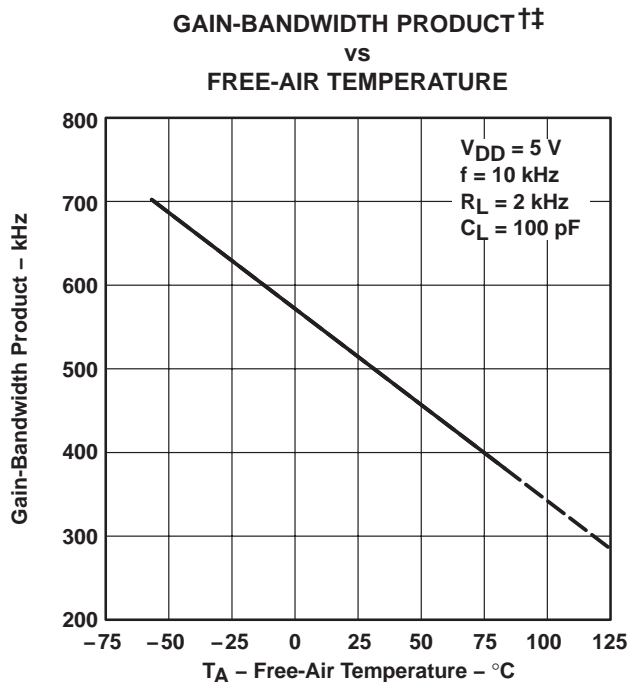

**Figure 48**

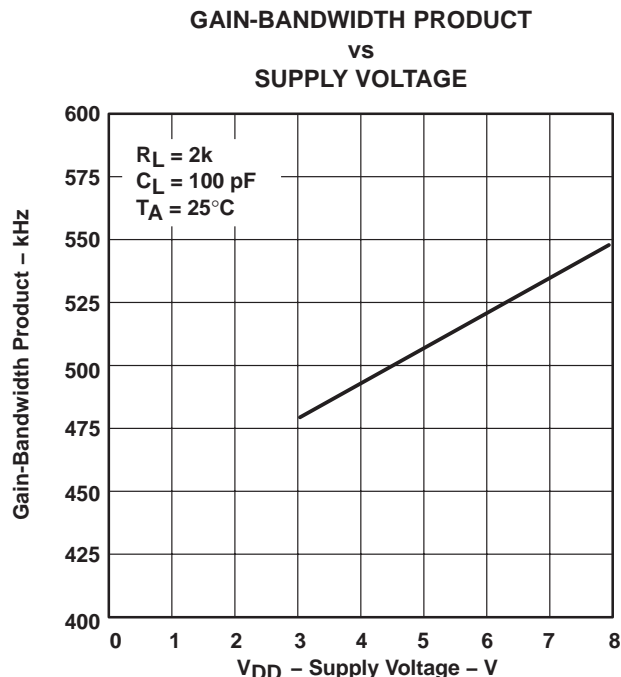

**Figure 49**

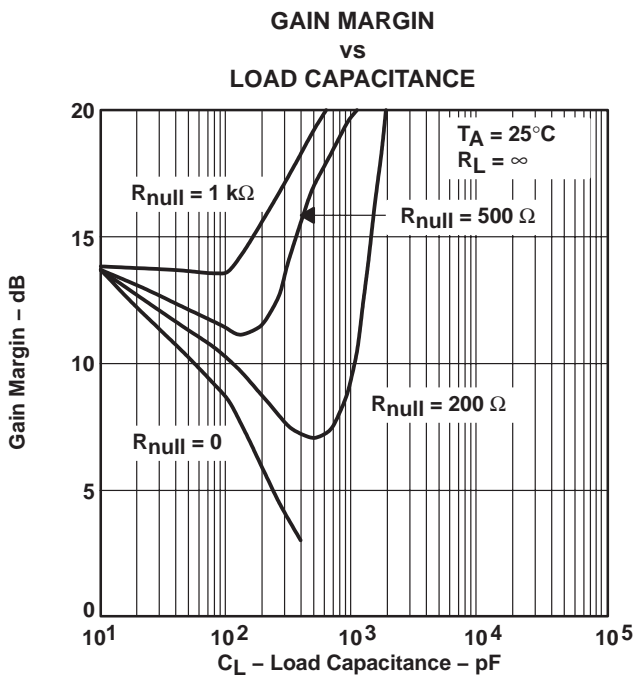

**Figure 50**

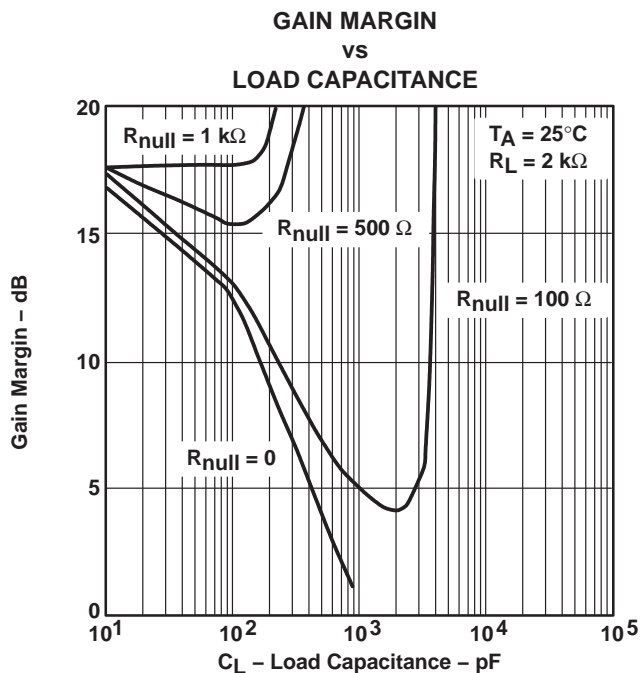

**Figure 51**

† Data at high and low temperatures are applicable only within the rated operating free-air temperature ranges of the various devices.  
 †† For all curves where  $V_{DD} = 5\text{ V}$ , all loads are referenced to 2.5 V. For all curves where  $V_{DD} = 3\text{ V}$ , all loads are referenced to 1.5 V.

**TYPICAL CHARACTERISTICS**

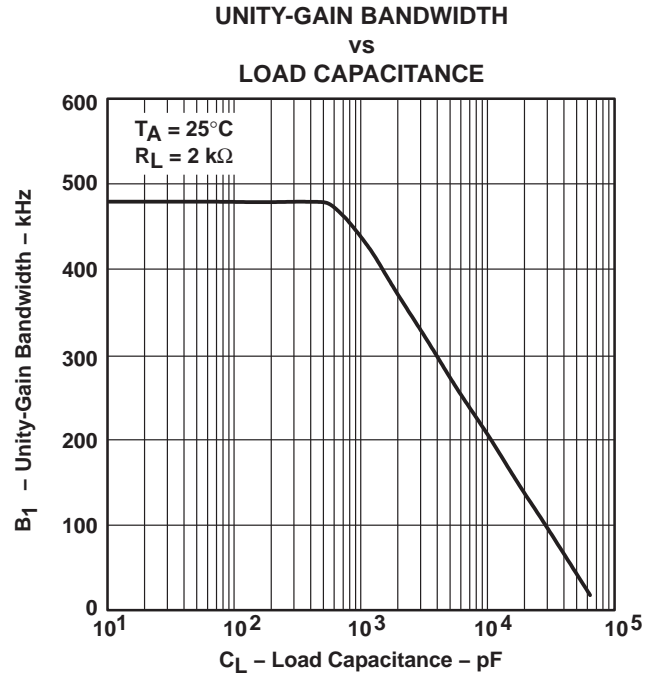
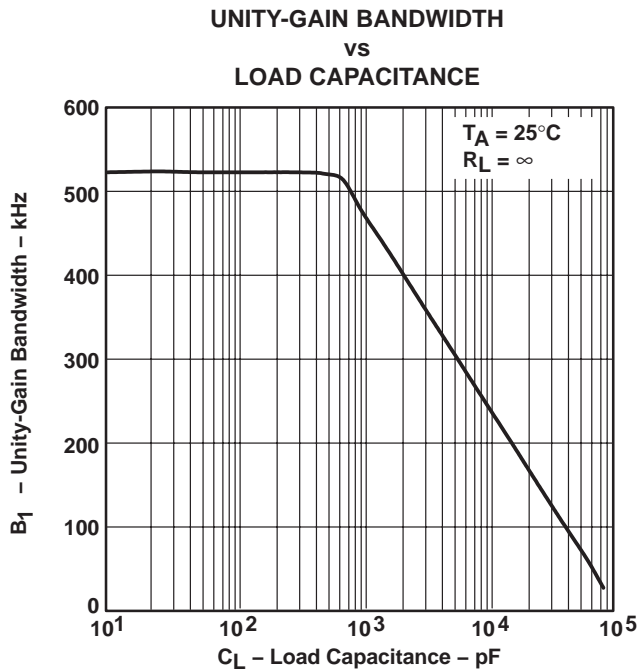
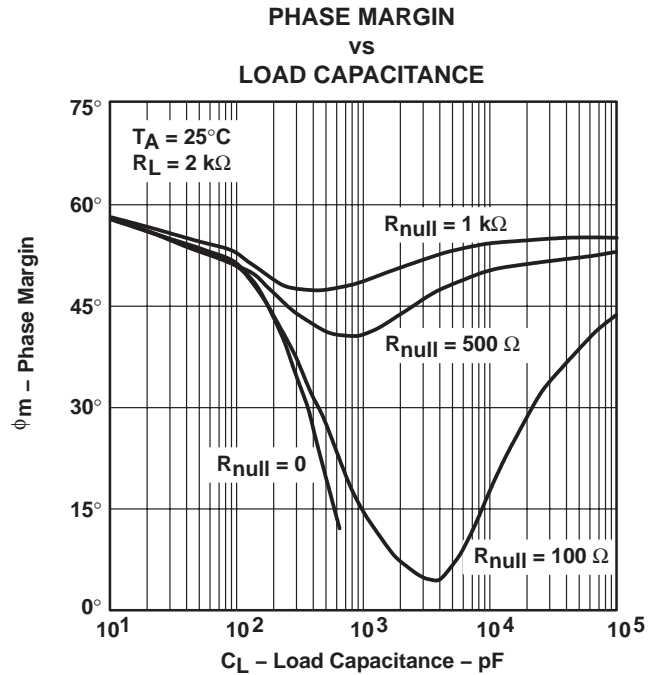
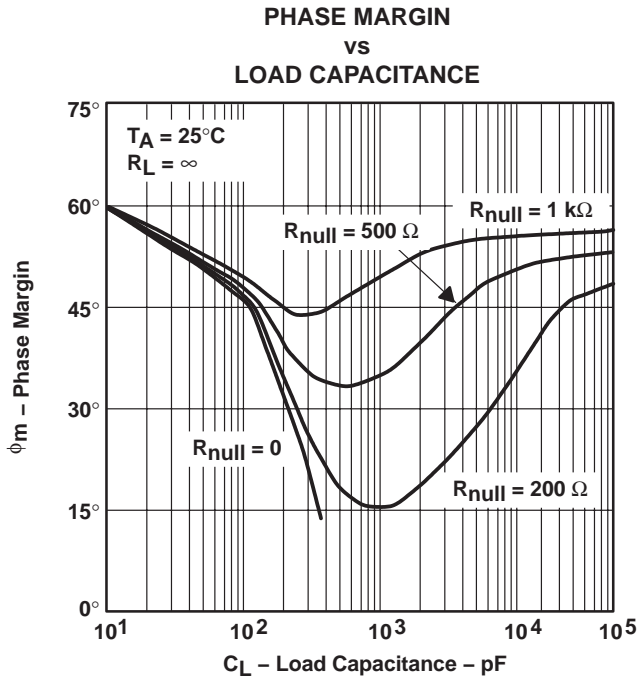



## APPLICATION INFORMATION

### driving large capacitive loads

The TLV2221 is designed to drive larger capacitive loads than most CMOS operational amplifiers. Figure 50 through Figure 55 illustrate its ability to drive loads greater than 100 pF while maintaining good gain and phase margins ( $R_{null} = 0$ ).

A small series resistor ( $R_{null}$ ) at the output of the device (Figure 56) improves the gain and phase margins when driving large capacitive loads. Figure 50 through Figure 53 show the effects of adding series resistances of 100  $\Omega$ , 200  $\Omega$ , 500  $\Omega$ , and 1 k $\Omega$ . The addition of this series resistor has two effects: the first effect is that it adds a zero to the transfer function and the second effect is that it reduces the frequency of the pole associated with the output load in the transfer function.

The zero introduced to the transfer function is equal to the series resistance times the load capacitance. To calculate the approximate improvement in phase margin, equation 1 can be used.

$$\Delta\phi_{m1} = \tan^{-1} \left( 2 \times \pi \times \text{UGBW} \times R_{null} \times C_L \right) \quad (1)$$

where :

- $\Delta\phi_{m1}$  = improvement in phase margin
- UGBW = unity-gain bandwidth frequency
- $R_{null}$  = output series resistance
- $C_L$  = load capacitance

The unity-gain bandwidth (UGBW) frequency decreases as the capacitive load increases (Figure 54 and Figure 55). To use equation 1, UGBW must be approximated from Figure 54 and Figure 55.

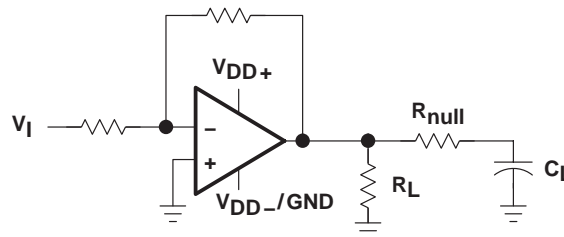

**Figure 56. Series-Resistance Circuit**

The TLV2221 is designed to provide better sinking and sourcing output currents than earlier CMOS rail-to-rail output devices. This device is specified to sink 500  $\mu\text{A}$  and source 1 mA at  $V_{DD} = 5\text{ V}$  at a maximum quiescent  $I_{DD}$  of 200  $\mu\text{A}$ . This provides a greater than 80% power efficiency.

When driving heavy dc loads, such as 2 k $\Omega$ , the positive edge under slewing conditions can experience some distortion. This condition can be seen in Figure 38. This condition is affected by three factors:

- Where the load is referenced. When the load is referenced to either rail, this condition does not occur. The distortion occurs only when the output signal swings through the point where the load is referenced. Figure 39 illustrates two 2-k $\Omega$  load conditions. The first load condition shows the distortion seen for a 2-k $\Omega$  load tied to 2.5 V. The third load condition in Figure 39 shows no distortion for a 2-k $\Omega$  load tied to 0 V.
- Load resistance. As the load resistance increases, the distortion seen on the output decreases. Figure 39 illustrates the difference seen on the output for a 2-k $\Omega$  load and a 100-k $\Omega$  load with both tied to 2.5 V.
- Input signal edge rate. Faster input edge rates for a step input result in more distortion than with slower input edge rates.

# TLV2221, TLV2221Y

## Advanced LinCMOS™ RAIL-TO-RAIL

### VERY LOW-POWER SINGLE OPERATIONAL AMPLIFIERS

SLOS157B – JUNE 1996 – REVISED APRIL 2005

## APPLICATION INFORMATION

### macromodel information

Macromodel information provided was derived using Microsim *Parts*™, the model generation software used with Microsim *PSpice*™. The Boyle macromodel (see Note 6) and subcircuit in Figure 57 are generated using the TLV2221 typical electrical and operating characteristics at  $T_A = 25^\circ\text{C}$ . Using this information, output simulations of the following key parameters can be generated to a tolerance of 20% (in most cases):

- Maximum positive output voltage swing
- Maximum negative output voltage swing
- Slew rate
- Quiescent power dissipation
- Input bias current
- Open-loop voltage amplification
- Unity-gain frequency
- Common-mode rejection ratio
- Phase margin
- DC output resistance
- AC output resistance
- Short-circuit output current limit

NOTE 6: G. R. Boyle, B. M. Cohn, D. O. Pederson, and J. E. Solomon, "Macromodeling of Integrated Circuit Operational Amplifiers", *IEEE Journal of Solid-State Circuits*, SC-9, 353 (1974).

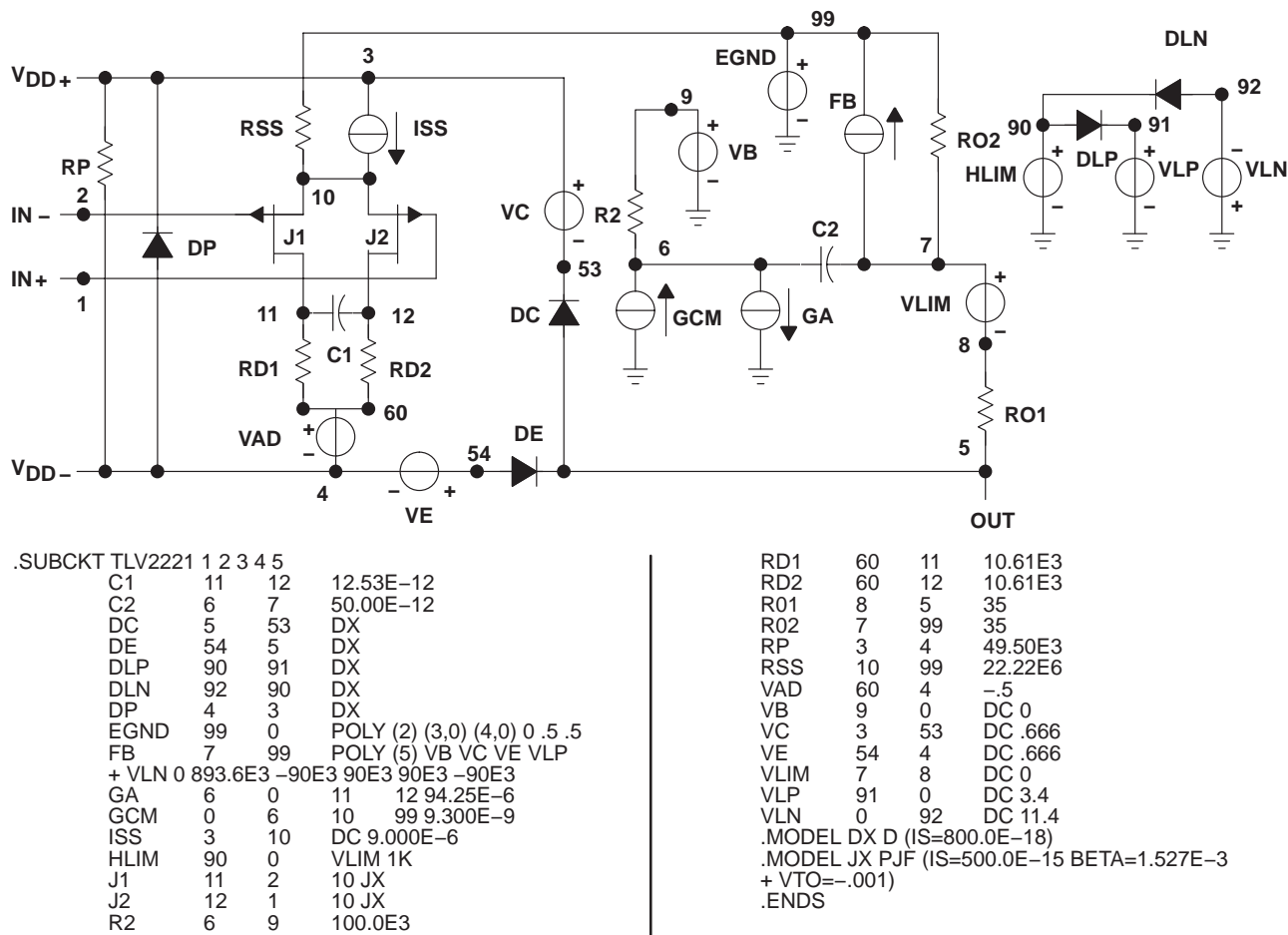

Figure 57. Boyle Macromodel and Subcircuit

*PSpice* and *Parts* are trademark of MicroSim Corporation.

Macromodels, simulation models, or other models provided by TI, directly or indirectly, are not warranted by TI as fully representing all of the specification and operating characteristics of the semiconductor product to which the model relates.

**PACKAGING INFORMATION**

Orderable Device	Status <sup>(1)</sup>	Package Type	Package Drawing	Pins	Package Qty	Eco Plan <sup>(2)</sup>	Lead/Ball Finish	MSL Peak Temp <sup>(3)</sup>
TLV2221CDBVR	ACTIVE	SOT-23	DBV	5	3000	Green (RoHS & no Sb/Br)	CU NIPDAU	Level-1-260C-UNLIM
TLV2221CDBVRG4	ACTIVE	SOT-23	DBV	5	3000	Green (RoHS & no Sb/Br)	CU NIPDAU	Level-1-260C-UNLIM
TLV2221CDBVT	ACTIVE	SOT-23	DBV	5	250	Green (RoHS & no Sb/Br)	CU NIPDAU	Level-1-260C-UNLIM
TLV2221CDBVTG4	ACTIVE	SOT-23	DBV	5	250	Green (RoHS & no Sb/Br)	CU NIPDAU	Level-1-260C-UNLIM
TLV2221IDBVR	ACTIVE	SOT-23	DBV	5	3000	Green (RoHS & no Sb/Br)	CU NIPDAU	Level-1-260C-UNLIM
TLV2221IDBVRG4	ACTIVE	SOT-23	DBV	5	3000	Green (RoHS & no Sb/Br)	CU NIPDAU	Level-1-260C-UNLIM
TLV2221IDBVT	ACTIVE	SOT-23	DBV	5	250	Green (RoHS & no Sb/Br)	CU NIPDAU	Level-1-260C-UNLIM
TLV2221IDBVTG4	ACTIVE	SOT-23	DBV	5	250	Green (RoHS & no Sb/Br)	CU NIPDAU	Level-1-260C-UNLIM

<sup>(1)</sup> The marketing status values are defined as follows:

**ACTIVE:** Product device recommended for new designs.

**LIFEBUY:** TI has announced that the device will be discontinued, and a lifetime-buy period is in effect.

**NRND:** Not recommended for new designs. Device is in production to support existing customers, but TI does not recommend using this part in a new design.

**PREVIEW:** Device has been announced but is not in production. Samples may or may not be available.

**OBSOLETE:** TI has discontinued the production of the device.

<sup>(2)</sup> Eco Plan - The planned eco-friendly classification: Pb-Free (RoHS), Pb-Free (RoHS Exempt), or Green (RoHS & no Sb/Br) - please check <http://www.ti.com/productcontent> for the latest availability information and additional product content details.

**TBD:** The Pb-Free/Green conversion plan has not been defined.

**Pb-Free (RoHS):** TI's terms "Lead-Free" or "Pb-Free" mean semiconductor products that are compatible with the current RoHS requirements for all 6 substances, including the requirement that lead not exceed 0.1% by weight in homogeneous materials. Where designed to be soldered at high temperatures, TI Pb-Free products are suitable for use in specified lead-free processes.

**Pb-Free (RoHS Exempt):** This component has a RoHS exemption for either 1) lead-based flip-chip solder bumps used between the die and package, or 2) lead-based die adhesive used between the die and leadframe. The component is otherwise considered Pb-Free (RoHS compatible) as defined above.

**Green (RoHS & no Sb/Br):** TI defines "Green" to mean Pb-Free (RoHS compatible), and free of Bromine (Br) and Antimony (Sb) based flame retardants (Br or Sb do not exceed 0.1% by weight in homogeneous material)

<sup>(3)</sup> MSL, Peak Temp. -- The Moisture Sensitivity Level rating according to the JEDEC industry standard classifications, and peak solder temperature.

**Important Information and Disclaimer:**The information provided on this page represents TI's knowledge and belief as of the date that it is provided. TI bases its knowledge and belief on information provided by third parties, and makes no representation or warranty as to the accuracy of such information. Efforts are underway to better integrate information from third parties. TI has taken and continues to take reasonable steps to provide representative and accurate information but may not have conducted destructive testing or chemical analysis on incoming materials and chemicals. TI and TI suppliers consider certain information to be proprietary, and thus CAS numbers and other limited information may not be available for release.

In no event shall TI's liability arising out of such information exceed the total purchase price of the TI part(s) at issue in this document sold by TI to Customer on an annual basis.

**TAPE AND REEL INFORMATION**



**QUADRANT ASSIGNMENTS FOR PIN 1 ORIENTATION IN TAPE**



\*All dimensions are nominal

Device	Package Type	Package Drawing	Pins	SPQ	Reel Diameter (mm)	Reel Width W1 (mm)	A0 (mm)	B0 (mm)	K0 (mm)	P1 (mm)	W (mm)	Pin1 Quadrant
TLV2221CDBVR	SOT-23	DBV	5	3000	180.0	9.0	3.15	3.2	1.4	4.0	8.0	Q3
TLV2221CDBVT	SOT-23	DBV	5	250	180.0	9.0	3.15	3.2	1.4	4.0	8.0	Q3
TLV2221IDBVR	SOT-23	DBV	5	3000	180.0	9.0	3.15	3.2	1.4	4.0	8.0	Q3
TLV2221IDBVT	SOT-23	DBV	5	250	180.0	9.0	3.15	3.2	1.4	4.0	8.0	Q3

**TAPE AND REEL BOX DIMENSIONS**



\*All dimensions are nominal

Device	Package Type	Package Drawing	Pins	SPQ	Length (mm)	Width (mm)	Height (mm)
TLV2221CDBVR	SOT-23	DBV	5	3000	182.0	182.0	20.0
TLV2221CDBVT	SOT-23	DBV	5	250	182.0	182.0	20.0
TLV2221IDBVR	SOT-23	DBV	5	3000	182.0	182.0	20.0
TLV2221IDBVT	SOT-23	DBV	5	250	182.0	182.0	20.0

DBV (R-PDSO-G5)

PLASTIC SMALL-OUTLINE PACKAGE



- NOTES:
- A. All linear dimensions are in millimeters.
  - B. This drawing is subject to change without notice.
  - C. Body dimensions do not include mold flash or protrusion. Mold flash and protrusion shall not exceed 0.15 per side.
  - D. Falls within JEDEC MO-178 Variation AA.

## IMPORTANT NOTICE

Texas Instruments Incorporated and its subsidiaries (TI) reserve the right to make corrections, modifications, enhancements, improvements, and other changes to its products and services at any time and to discontinue any product or service without notice. Customers should obtain the latest relevant information before placing orders and should verify that such information is current and complete. All products are sold subject to TI's terms and conditions of sale supplied at the time of order acknowledgment.

TI warrants performance of its hardware products to the specifications applicable at the time of sale in accordance with TI's standard warranty. Testing and other quality control techniques are used to the extent TI deems necessary to support this warranty. Except where mandated by government requirements, testing of all parameters of each product is not necessarily performed.

TI assumes no liability for applications assistance or customer product design. Customers are responsible for their products and applications using TI components. To minimize the risks associated with customer products and applications, customers should provide adequate design and operating safeguards.

TI does not warrant or represent that any license, either express or implied, is granted under any TI patent right, copyright, mask work right, or other TI intellectual property right relating to any combination, machine, or process in which TI products or services are used. Information published by TI regarding third-party products or services does not constitute a license from TI to use such products or services or a warranty or endorsement thereof. Use of such information may require a license from a third party under the patents or other intellectual property of the third party, or a license from TI under the patents or other intellectual property of TI.

Reproduction of TI information in TI data books or data sheets is permissible only if reproduction is without alteration and is accompanied by all associated warranties, conditions, limitations, and notices. Reproduction of this information with alteration is an unfair and deceptive business practice. TI is not responsible or liable for such altered documentation. Information of third parties may be subject to additional restrictions.

Resale of TI products or services with statements different from or beyond the parameters stated by TI for that product or service voids all express and any implied warranties for the associated TI product or service and is an unfair and deceptive business practice. TI is not responsible or liable for any such statements.

TI products are not authorized for use in safety-critical applications (such as life support) where a failure of the TI product would reasonably be expected to cause severe personal injury or death, unless officers of the parties have executed an agreement specifically governing such use. Buyers represent that they have all necessary expertise in the safety and regulatory ramifications of their applications, and acknowledge and agree that they are solely responsible for all legal, regulatory and safety-related requirements concerning their products and any use of TI products in such safety-critical applications, notwithstanding any applications-related information or support that may be provided by TI. Further, Buyers must fully indemnify TI and its representatives against any damages arising out of the use of TI products in such safety-critical applications.

TI products are neither designed nor intended for use in military/aerospace applications or environments unless the TI products are specifically designated by TI as military-grade or "enhanced plastic." Only products designated by TI as military-grade meet military specifications. Buyers acknowledge and agree that any such use of TI products which TI has not designated as military-grade is solely at the Buyer's risk, and that they are solely responsible for compliance with all legal and regulatory requirements in connection with such use.

TI products are neither designed nor intended for use in automotive applications or environments unless the specific TI products are designated by TI as compliant with ISO/TS 16949 requirements. Buyers acknowledge and agree that, if they use any non-designated products in automotive applications, TI will not be responsible for any failure to meet such requirements.

Following are URLs where you can obtain information on other Texas Instruments products and application solutions:

### Products

Amplifiers	<a href="http://amplifier.ti.com">amplifier.ti.com</a>
Data Converters	<a href="http://dataconverter.ti.com">dataconverter.ti.com</a>
DSP	<a href="http://dsp.ti.com">dsp.ti.com</a>
Clocks and Timers	<a href="http://www.ti.com/clocks">www.ti.com/clocks</a>
Interface	<a href="http://interface.ti.com">interface.ti.com</a>
Logic	<a href="http://logic.ti.com">logic.ti.com</a>
Power Mgmt	<a href="http://power.ti.com">power.ti.com</a>
Microcontrollers	<a href="http://microcontroller.ti.com">microcontroller.ti.com</a>
RFID	<a href="http://www.ti-rfid.com">www.ti-rfid.com</a>
RF/IF and ZigBee® Solutions	<a href="http://www.ti.com/lprf">www.ti.com/lprf</a>

### Applications

Audio	<a href="http://www.ti.com/audio">www.ti.com/audio</a>
Automotive	<a href="http://www.ti.com/automotive">www.ti.com/automotive</a>
Broadband	<a href="http://www.ti.com/broadband">www.ti.com/broadband</a>
Digital Control	<a href="http://www.ti.com/digitalcontrol">www.ti.com/digitalcontrol</a>
Medical	<a href="http://www.ti.com/medical">www.ti.com/medical</a>
Military	<a href="http://www.ti.com/military">www.ti.com/military</a>
Optical Networking	<a href="http://www.ti.com/opticalnetwork">www.ti.com/opticalnetwork</a>
Security	<a href="http://www.ti.com/security">www.ti.com/security</a>
Telephony	<a href="http://www.ti.com/telephony">www.ti.com/telephony</a>
Video & Imaging	<a href="http://www.ti.com/video">www.ti.com/video</a>
Wireless	<a href="http://www.ti.com/wireless">www.ti.com/wireless</a>

Mailing Address: Texas Instruments, Post Office Box 655303, Dallas, Texas 75265  
Copyright © 2008, Texas Instruments Incorporated