

RPL-5.0 Series / Power Module

5 Amp / 2.75-17VDC / 24 Pad QFN Package

FEATURES

- Buck regulator power module with integrated shielded inductor
- 17V maximum input voltage
- Programmable 0.6 - 12V output voltage
- 5A maximum output current
- SCP, OCP and UVLO protection
- 3mm x 3mm x 2mm QFN package
- Flip-Chip technology for improved thermal management
- Efficiency up to 90%



Dimensions (LxWxH): 4.0 x 6.0 x 1.6mm (0.157 x 0.236 x 0.628inch)
0.1g (0.002lbs)

APPLICATIONS



SAFETY & EMC



DESCRIPTION

RECOM's RPL-5.0 series is a pinnacle in power module technology that sets a new standard for compactness and performance within its portfolio. This state-of-the-art Non-Isolated Step-Down Power Module is meticulously designed to be the smallest and most powerful in its class, embodying innovation and efficiency. The RPL-5.0 series features a cutting-edge buck regulator power module with an integrated shielded inductor. With a maximum input voltage of 17V, it ensures stable and reliable power conversion, catering to a diverse array of point of load applications with precision. This module offers unparalleled flexibility, allowing for programmable output voltages ranging from 0.6V to 12V. This adaptability makes the RPL-5.0 series a versatile solution, seamlessly integrating into a variety of system requirements. Capable of delivering up to 5A maximum output current, this power module is engineered to meet the dynamic needs of contemporary electronics. Safety is ingrained in its design, featuring Short Circuit Protection (SCP), Overcurrent Protection (OCP) and Undervoltage Lockout (UVLO) features to ensure the longevity and safeguarding of connected devices. Packaged in an incredibly compact 3mm x 3mm x 2mm QFN package, the RPL-5.0 series redefines expectations for size in its class, revolutionizing the landscape of power modules. The incorporation of Flip-Chip technology further enhances thermal management, enabling efficient operation even in the most demanding conditions. With an efficiency rating of up to 90%, the RPL-5.0 series not only meets but surpasses industry standards. This remarkable efficiency not only minimizes energy consumption but also mitigates heat generation, contributing to the overall reliability and extended lifespan of the module. The RPL-5.0 series is one of the smallest and most potent Non-Isolated Step-Down Power Module in its class, embodying the perfect blend of compact design, power, and efficiency.

SELECTION GUIDE

Part Number	Input Voltage Range [VDC]	Output Voltage Range [VDC]	Output Current max. [A]	Efficiency ⁽¹⁾ typ. [%]
RPL-5.0	2.75 - 17	0.6 - 12	5000	90

Note1: Efficiency is tested at V_{IN} = 5VDC, full load at +25°C ambient and V_{OUT} = 3.3VDC

MODEL NUMBERING

RPL-5.0-
 Output Current _____ Packaging ⁽²⁾

Note2: Add suffix "-R" for tape and reel packaging
 Add suffix "-CT" for bag packaging (refer to „Packaging information“)

RPL-5.0 series / Power Module

5 Amp / 2.75-17VDC / 24 Pad QFN Package

ABSOLUTE MAXIMUM RATINGS (measured @ $T_{AMB} = 25^{\circ}C$, nom. V_{IN} , full load and after warm-up unless otherwise stated)

Parameter	Symbol	Min.	Typ.	Max.
Absolute maximum voltage	V_{IN}	-0.3VDC		20VDC
	V_{SW}	-0.3VDC		$V_{IN} + 0.7VDC$
	others	-0.3VDC		4VDC
Maximum continuous power losses ⁽³⁾	$T_{AMB} = +25^{\circ}C$			3.816W
Junction Temperature	T_J			+150°C
Lead Temperature				+260°C

Note3: Exceeding maximum allowable power dissipation causes device to enter thermal shutdown which protects device from permanent damage.

BASIC CHARACTERISTICS (measured @ $T_{AMB} = 25^{\circ}C$, nom. V_{IN} , full load and after warm-up unless otherwise stated)

Parameter	Symbol	Condition	Min.	Typ.	Max.
Input voltage range	V_{IN}	refer to „Safe Operating Area“	2.75VDC		17VDC
Quiescent current	I_Q	$V_{CTRL} = 2VDC, V_{FB} = 0.65VDC$		100µA	150µA
Output voltage range	V_{OUT}	refer to „Safe Operating Area“	0.6VDC		12VDC
			0.6VDC		$V_{IN} \times D_{max}$
Standby current	I_{IN}	$V_{CTRL} = 0VDC$		2µA	5µA
Feedback voltage	V_{FB}		594mV	600mV	606mV
		$T_{AMB} = -40^{\circ}C$ to $125^{\circ}C$	591mV	600mV	609mV
Feedback current		$V_{FB} = 700mV$		10nA	50nA
Valley current limit			6A	7A	
Switching frequency	f_{SW}		0.9kHz	1.2kHz	1.6kHz
Minimum on time				50ns	
Minimum off time				100ns	
Soft start current			4µA	6µA	8µA

Typical Application

$V_{IN} = 2.75-17VDC, V_{OUT} = 1VDC, I_{OUT} = 6A$

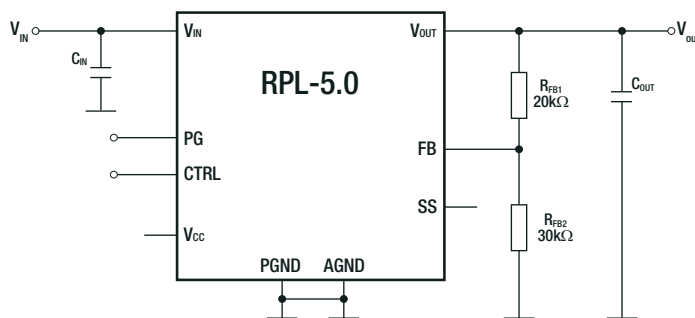

Safe Operating Area

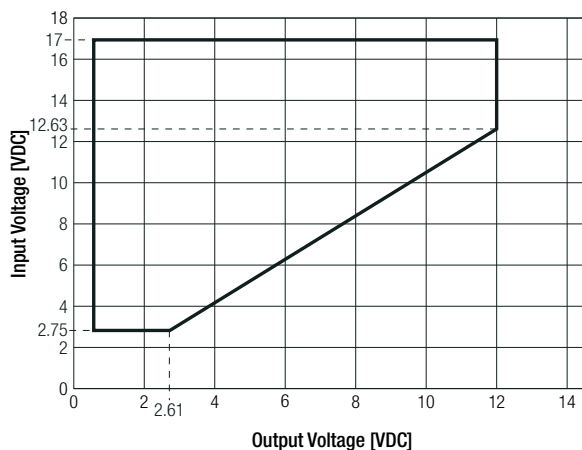

RPL-5.0 series / Power Module

5 Amp / 2.75-17VDC / 24 Pad QFN Package



CTRL OPERATING CONDITIONS (measured @ $T_{AMB}= 25^{\circ}C$, $V_{IN}= 5VDC$, full load and after warm-up unless otherwise stated)

Parameter	Symbol	Condition	Min.	Typ.	Max.
CTRL rising threshold	V_{CTRL_RISING}		1.19VDC	1.23VDC	1.27VDC
CTRL falling threshold	$V_{CTRL_FALLING}$		0.96VDC	1VDC	1.04VDC
CTRL pull-down resistor				1.2M Ω	

POWER GOOD OPERATING CONDITIONS (measured @ $T_{AMB}= 25^{\circ}C$, $V_{IN}= 5VDC$, full load and after warm-up unless otherwise stated)

Parameter	Symbol	Condition	Min.	Typ.	Max.
OV rising threshold	PG_{OVHI}		115% of V_{REF}	120% of V_{REF}	125% of V_{REF}
OV falling threshold	PG_{OVLO}		105% of V_{REF}	110% of V_{REF}	115% of V_{REF}
UV rising threshold	PG_{UVHI}		85% of V_{REF}	90% of V_{REF}	95% of V_{REF}
UV falling threshold	PG_{UVLO}		75% of V_{REF}	80% of V_{REF}	85% of V_{REF}
Delay	PG_{DELAY}	both edges		50 μ s	
Leakage current	I_{PG_LEAK}	$V_{PG}= 5VDC$			10 μ A
Sink current capability	V_{PG_SINK}	$sink_{current}= 4mA$			0.4VDC

VCC CONDITIONS (measured @ $T_{AMB}= 25^{\circ}C$, $V_{IN}= 5VDC$, full load and after warm-up unless otherwise stated)

Parameter	Condition	Min.	Typ.	Max.
Regulator	$V_{IN}= 5VDC$		3.5VDC	
Load regulation	$I_{CC}= 5mA$		3%	
UVLO rising threshold		2.4VDC	2.5VDC	2.6VDC
UVLO threshold hysteresis			200mV	

PROTECTIONS (measured @ $T_{AMB}= 25^{\circ}C$, $V_{IN}= 5VDC$, full load and after warm-up unless otherwise stated)

Parameter	Condition	Value	
Short Circuit Protection SCP		hiccup, auto recovery	
Over Current Protection OCP		hiccup, auto recovery	
Thermal shutdown	restart after cooldown	junction temperature	150 $^{\circ}C$ typ.
		hysteresis	20 $^{\circ}C$ typ.

THERMAL OPERATING CONDITIONS (measured @ $T_{AMB}= 25^{\circ}C$, $V_{IN}= 5VDC$, full load and after warm-up unless otherwise stated)

Parameter	Symbol	Condition	Min.	Typ.	Max.
Operating Junction Temperature	T_J	refer to „Thermal Derating“	-40 $^{\circ}C$		+125 $^{\circ}C$
Thermal Resistance ⁽⁴⁾	R_{thJA}	junction to ambient		32.8K/W	
	R_{thJC}	junction to case		10.2K/W	

Note4: Test PCB= 6.4 x 6.4cm double sided PCB with 20oz copper, natural convection

ENVIRONMENTAL

Parameter	Condition	Value
Moisture Sensitive Level		Level 3, 245 $^{\circ}C$, 168hrs

OUTPUT VOLTAGE SETTING

The external resistor divider sets V_{OUT}. First, choose a value for R₂. Too small of an R₂ value leads to considerable quiescent current (I_Q) loss, while too large an R₂ value makes FB noise sensitive. It is recommended that R₂ be between 2kΩ and 100kΩ. Typically, set the current flowing through R₂ below 250μA to balance system stability and minimize load loss. Then R₁ can be calculated with Equation below:

Feedback Network

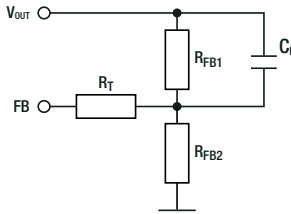

Calculation:

$$R_{FB1} = \frac{(V_{OUT} - V_{ref})}{V_{ref}} \times R_{FB2}$$

Practical example with V_{OUT} = 1.8VDC

$$R_{FB1} = \frac{(1.8V - 0.6V)}{0.6V} \times 10k\Omega = 20k\Omega$$

Table below lists recommended resistor values for common V_{OUT}:

V _{OUT} [VDC]	R _{FB1} [Ω]	R _{FB2} [Ω]	C _F [pF]	R _T [Ω]
1	20k	30k	39	0
1.2		20k		
1.5		13k		
1.8		10k		
2.5		6k34		
3.3		4k42		

*(according to E96)

TYPICAL PERFORMANCE CHARACTERISTICS (measured @ T_{AMB} = 25°C, V_{OUT} = 1.8VDC)

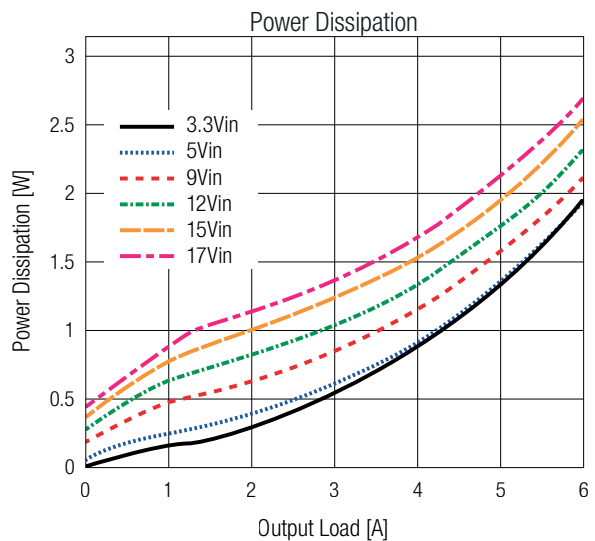
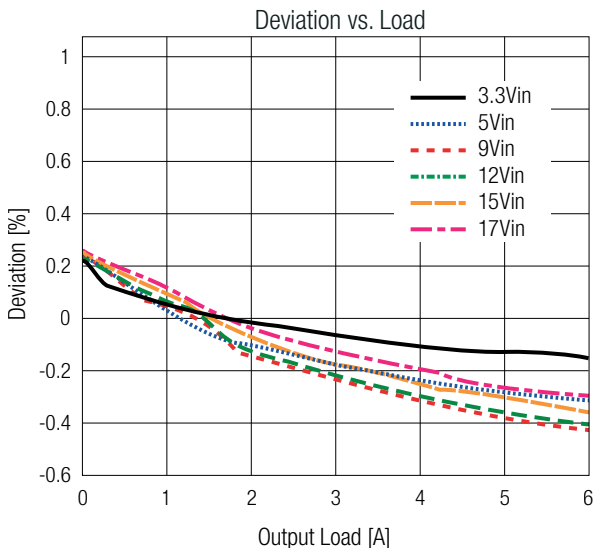
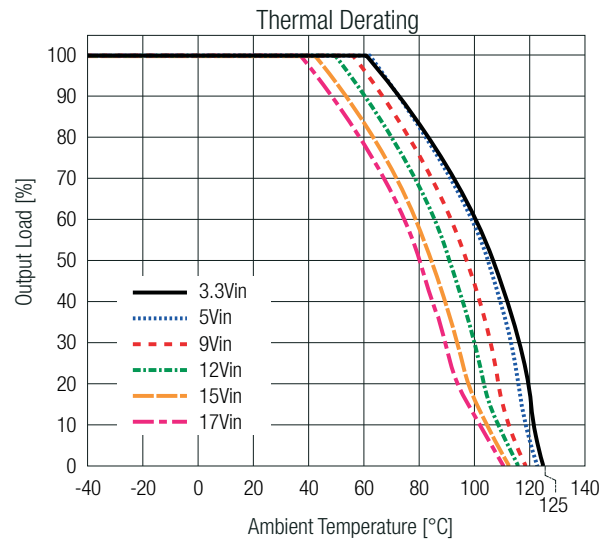
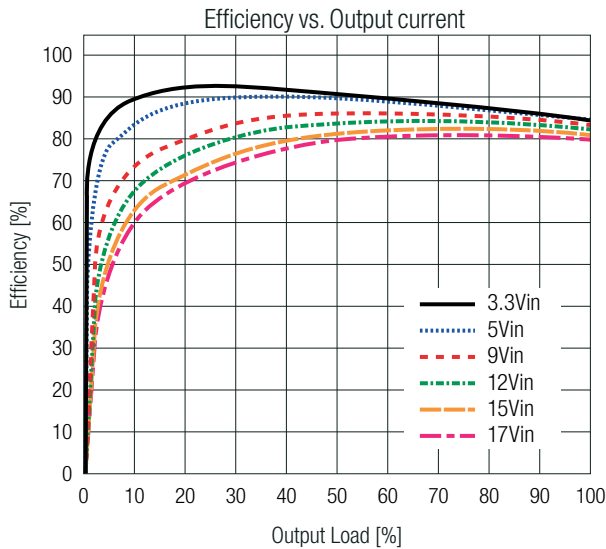

RPL-5.0 series / Power Module

5 Amp / 2.75-17VDC / 24 Pad QFN Package

TYPICAL PERFORMANCE CHARACTERISTICS (measured @ $T_{AMB} = 25^{\circ}C$, $V_{OUT} = 3.3VDC$)

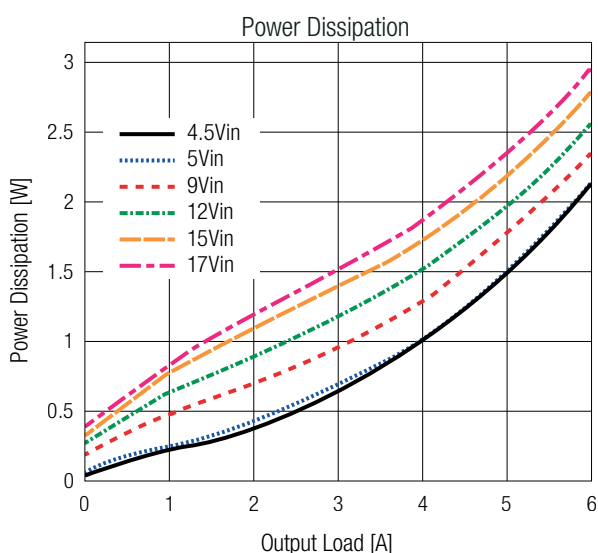
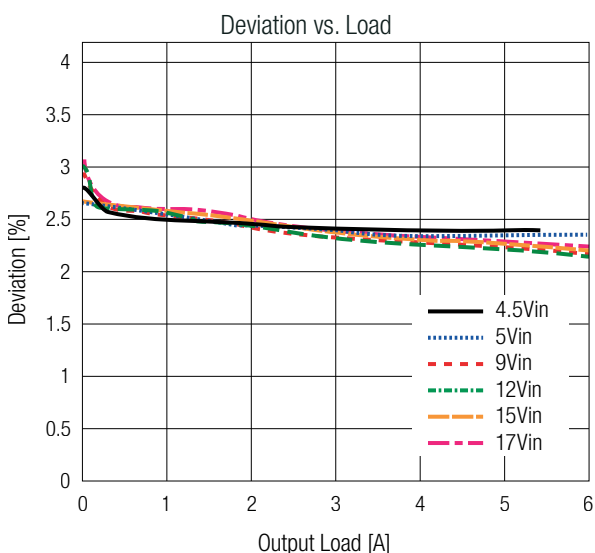
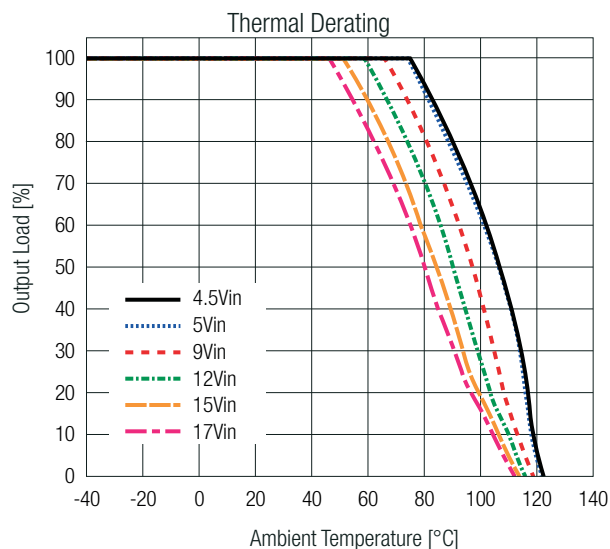
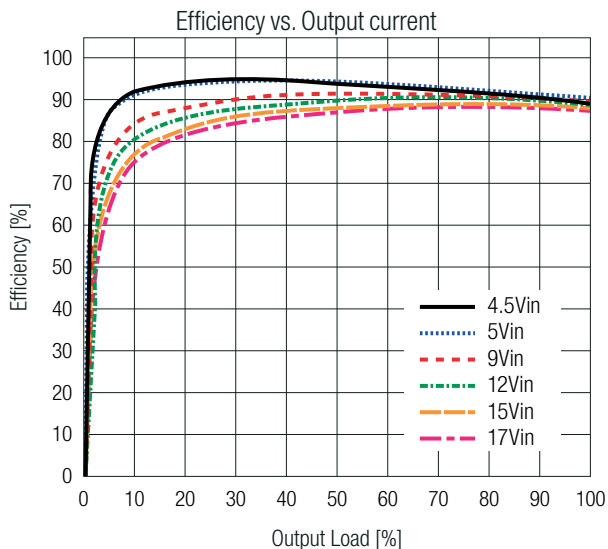

SAFETY & CERTIFICATIONS

Certificate Type (Safety)	Report Number	Standard
RoHS2		RoHS 2011/65EU + AM2015/863

DIMENSION & PHYSICAL CHARACTERISTICS

Parameter	Type	Value
Material	case	plastic
Dimension (LxWxH)		4.0 x 6.0 x 1.6mm 0.157 x 0.236 x 0.629inch
Weight		0.1g typ. 0.0002lbs

DIMENSION & PHYSICAL CHARACTERISTICS

Dimension Drawing (mm)

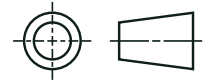
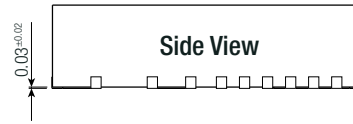
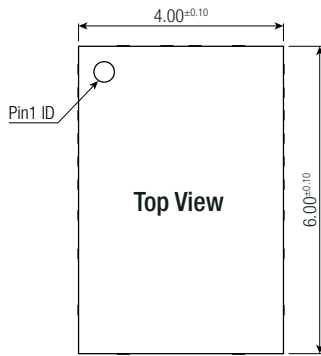

Bottom View

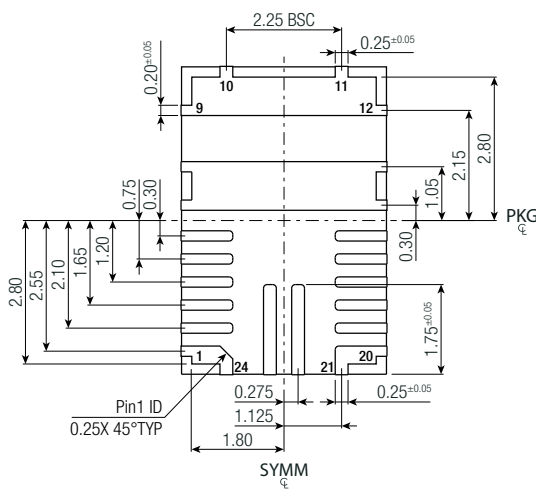

Recommended Footprint Details (Top View)

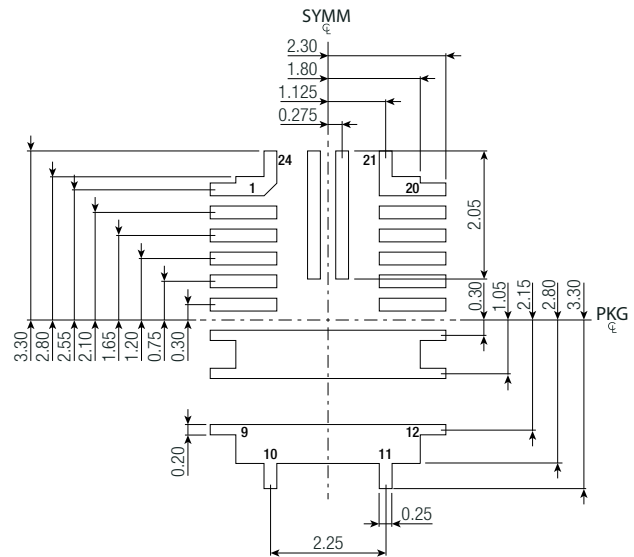

Pad Information

Pad #	Function	Description
1, 2, 3, 4, 5, 24	PGND	System ground. Reference ground of the regulated output voltage. Connect to input supply return, load return, and input and output capacitors.
6	VCC	Internal bias supply output
7, 8, 13, 14, 23	SW	Switch output
9, 10, 11, 12	V _{OUT}	Output voltage pin. Connect the V _{OUT} pin to the output capacitor (C _{OUT})
15	BST	Bootstrap
16	CTRL	Control Pin. Pull the CTRL pin high to turn the part on; float CTRL to turn it off. CTRL is pulled to AGND via an internal 1.2MΩ pull-down resistor (R _{CTRL_PD})
17	FB	Feedback. To set V _{OUT} connect the FB pin to the tap of an external resistor divider connected between the output and AGND.
18	AGND	Signal Ground. The AGND pin is not connected internally to the system ground. When designing the PCB layout, ensure that AGND is connected to the system ground.
19	SS	Soft Start. Connect a capacitor between the SS pin and AGND to set the soft-start time (t _{SS}) and to avoid start-up inrush current. SS has an internal 22nF capacitor (C _{SS}).
20, 21	PG	Power good output.
22	V _{IN}	Input supply voltage. Connect using wide PCB traces. Requires CIN between these pins and PGND close to the pins.

Tolerances:
 x.x= ±0.1mm
 x.xx= ±0.05mm

RPL-5.0 series / Power Module

5 Amp / 2.75-17VDC / 24 Pad QFN Package



PACKAGING INFORMATION

Parameter	Type	Value
Packaging Dimension (LxWxH)	Suffix -R: tape & reel	355.6 x 355.6 x 50.8mm
		14.0 x 14.0 x 2.0inch
	Suffix -CT: moisture barrier bag	100 x 100 x 30mm
		3.94 x 3.94 x 1.18inch
Packaging Quantity	Suffix -R: tape & reel	500pcs.
	Suffix -CT: moisture barrier bag	10pcs.
Storage Temperature Range		-65°C to +150°C
Storage Humidity	non-condensing	60% RH max.

The product information and specifications may be subject to changes even without prior written notice. The product has been designed for various applications; its suitability lies in the responsibility of each customer. The products are not authorized for use in safety-critical applications without RECOM's explicit written consent. A safety-critical application is an application where a failure may reasonably be expected to endanger or cause loss of life, inflict bodily harm or damage property. The applicant shall indemnify and hold harmless RECOM, its affiliated companies and its representatives against any damage claims in connection with the unauthorized use of RECOM products in such safety-critical applications.