

Oct.1.2023 Copyright 2023 HIROSE ELECTRIC CO., LTD. All Rights Reserved.
In case of consideration for using Automotive equipment / device which demand high reliability, kindly contact our sales window

COUNT	DESCRIPTION OF REVISIONS	BY	CHKD	DATE	COUNT	DESCRIPTION OF REVISIONS	BY	CHKD	DATE
1	DIS-P-000739	KUDO	OIZUMI	14. 7. 1					
3	DIS-P-00000896	HOSHINO	TOKUTA	20. 9. 11					

△ CHANGED THE POSITION OF LOT No.

HRS DRAWING FOR REFERENCE

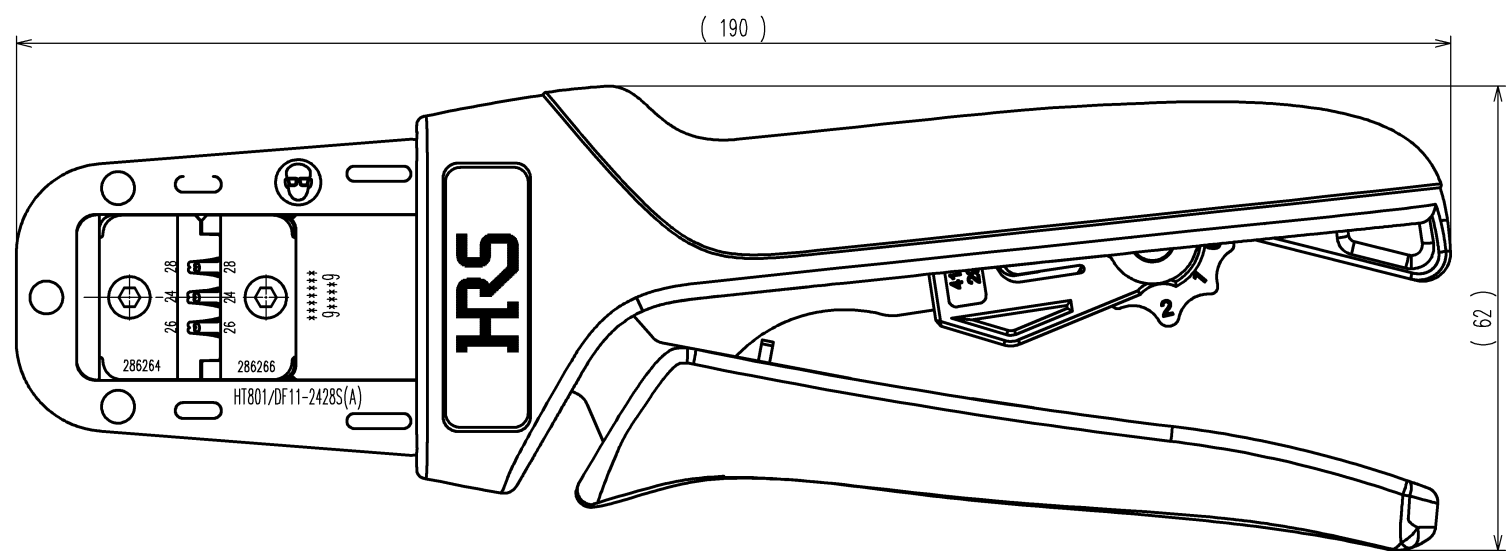
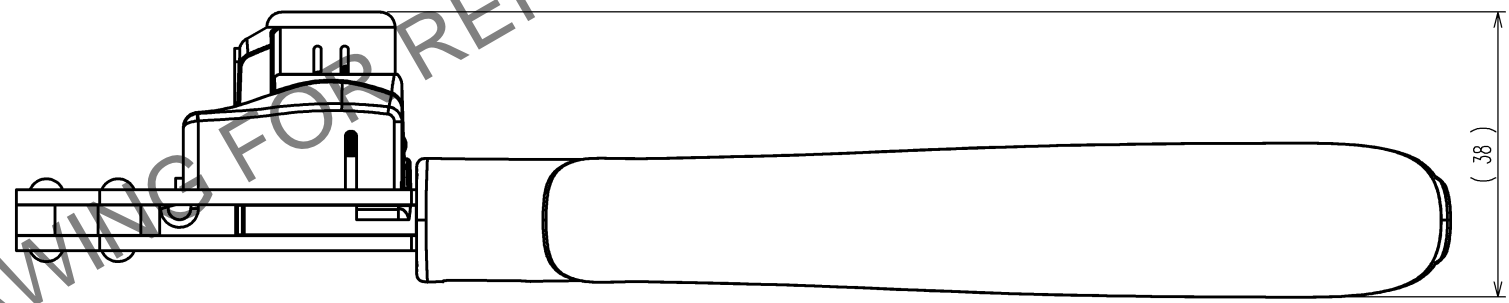

△ CHANGED PRODUCT NAME DISPLAY

△ Notes : Contact of DF11-2428SC(CL0543-0501-5) and DF11-2428SCA(CL0543-0551-3)
DF51K-2428SC(800)(CL0480-0584-0) , DF51K-2428SCA(800)(CL0480-0615-0) is assembled for this tool.

2			4		
1			3		
NO.	MATERIAL	FINISH, REMARKS	NO.	MATERIAL	FINISH, REMARKS
CODE NO. (OLD) CL			DRAWN	DESIGNED	CHECKED
			K.KIMURA	K.KIMURA	S.OIZUMI
			13.2.15	13.2.15	13.2.16
			APPROVED	RELEASED	
			T.ITO		
			13.2.16		
DRAWING NO.			PART NO.		
EDC-276273-00-00			△ HT801/DF11-2428S(A)		
SCALE			CODE NO.		
1 : 1			CL550-0403-4		
UNITS			1/1		
mm					

TO
PE