

## 2A, 40V - 200V Schottky Barrier Surface Mount Rectifier

### FEATURES

- AEC-Q101 qualified
- Low power loss, high efficiency
- Ideal for automated placement
- Guard ring for over-voltage protection
- High surge current capability
- Moisture sensitivity level: level 1, per J-STD-020
- RoHS Compliant
- Halogen-free

### APPLICATIONS

- Low voltage, high frequency, inverter
- DC/DC converter
- Freewheeling diodes
- Reverse battery protection
- Car lighting

### MECHANICAL DATA

- Case: SOD-123W
- Molding compound meets UL 94V-0 flammability rating
- Terminal: Matte tin plated leads, solderable per J-STD-002
- Meet JESD 201 class 2 whisker test
- Polarity: Indicated by cathode band
- Weight: 0.016g (approximately)

KEY PARAMETERS		
PARAMETER	VALUE	UNIT
$I_F$	2	A
$V_{RRM}$	40 - 200	V
$I_{FSM}$	50	A
$T_{JMAX}$	150	°C
Package	SOD-123W	
Configuration	Single die	


**HALOGEN  
FREE**

**SOD-123W**


ABSOLUTE MAXIMUM RATINGS ( $T_A = 25^\circ\text{C}$ unless otherwise noted)							
PARAMETER	SYMBOL	SS24 LWH	SS26 LWH	SS210 LWH	SS215 LWH	SS220 LWH	UNIT
Marking code on the device		24LW	26LW	20LW	2ALW	2BLW	
Repetitive peak reverse voltage	$V_{RRM}$	40	60	100	150	200	V
Reverse voltage, total rms value	$V_{R(RMS)}$	28	42	70	105	140	V
Forward current	$I_F$	2					A
Peak forward surge current, 8.3ms single half sine-wave superimposed on rated load	$I_{FSM}$	50					A
Junction temperature	$T_J$	- 55 to +150					°C
Storage temperature	$T_{STG}$	- 55 to +150					°C

<b>THERMAL PERFORMANCE</b>			
<b>PARAMETER</b>	<b>SYMBOL</b>	<b>TYP</b>	<b>UNIT</b>
Junction-to-lead thermal resistance	$R_{\theta JL}$	25	°C/W
Junction-to-ambient thermal resistance	$R_{\theta JA}$	80	°C/W

<b>ELECTRICAL SPECIFICATIONS</b> ( $T_A = 25^\circ\text{C}$ unless otherwise noted)						
<b>PARAMETER</b>		<b>CONDITIONS</b>	<b>SYMBOL</b>	<b>TYP</b>	<b>MAX</b>	<b>UNIT</b>
Forward voltage <sup>(1)</sup>	SS24LWH	$I_F = 2\text{A}, T_J = 25^\circ\text{C}$	$V_F$	-	0.55	V
	SS26LWH			-	0.70	V
	SS210LWH			-	0.85	V
	SS215LWH SS220LWH			-	0.95	V
Reverse current @ rated $V_R$ <sup>(2)</sup>	SS24LWH SS26LWH	$T_J = 25^\circ\text{C}$	$I_R$	-	200	$\mu\text{A}$
	SS210LWH			-	20	$\mu\text{A}$
	SS215LWH SS220LWH			-	10	$\mu\text{A}$

**Notes:**

1. Pulse test with  $PW = 0.3\text{ms}$
2. Pulse test with  $PW = 30\text{ms}$

<b>ORDERING INFORMATION</b>		
<b>ORDERING CODE</b> <sup>(1)</sup>	<b>PACKAGE</b>	<b>PACKING</b>
SS2xLWH	SOD-123W	10,000 / Tape & Reel

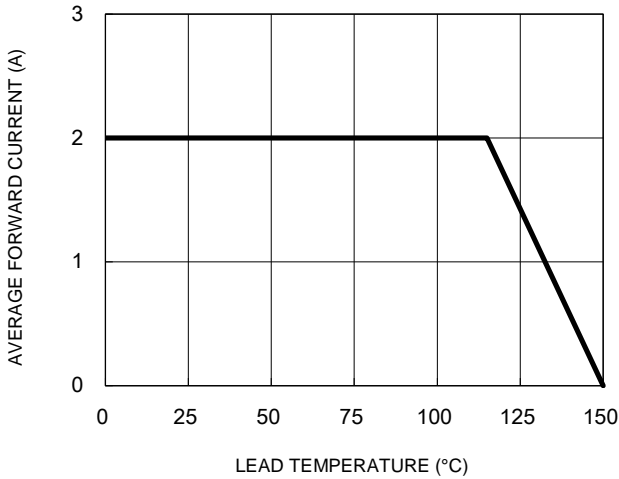
**Notes:**

1. "x" defines voltage from 40V(SS24LWH) to 200V(SS220LWH)

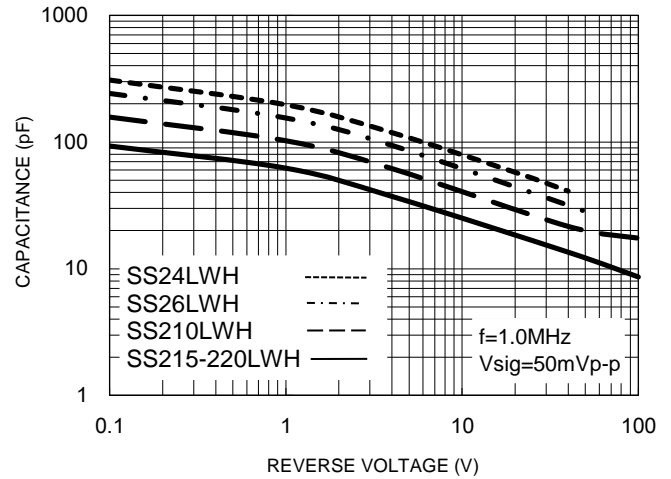
**CHARACTERISTICS CURVES**

( $T_A = 25^\circ\text{C}$  unless otherwise noted)

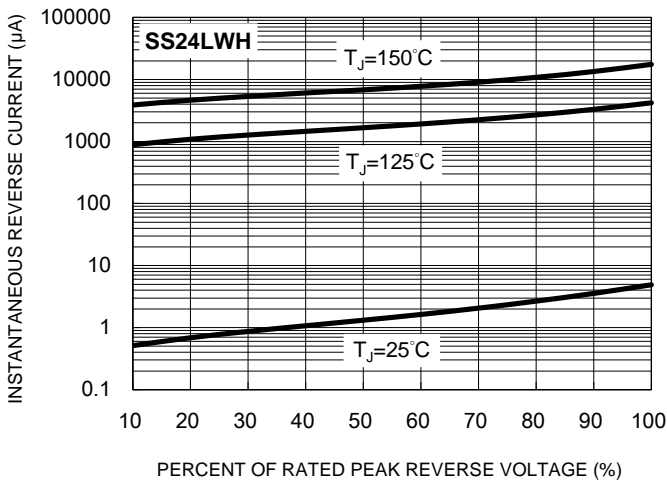
**Fig.1 Forward Current Derating Curve**



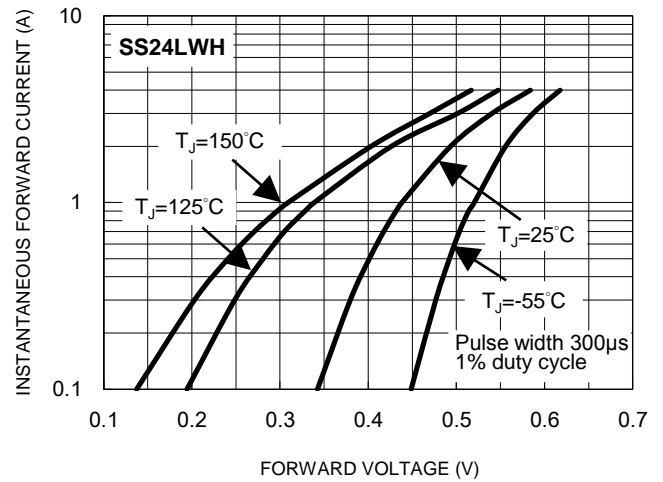
**Fig.2 Typical Junction Capacitance**



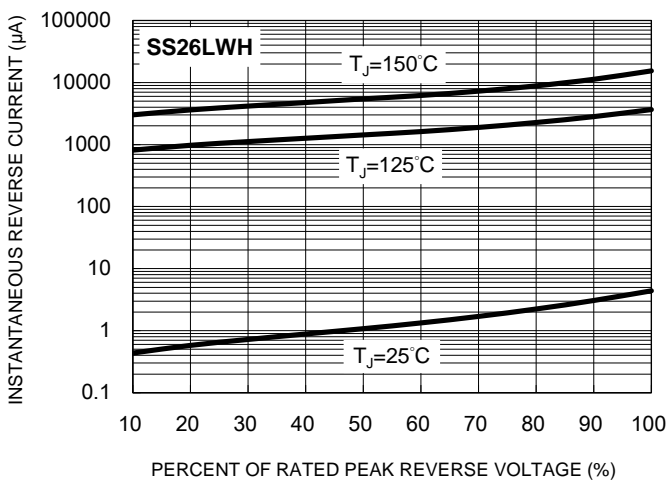
**Fig.3 Typical Reverse Characteristics**



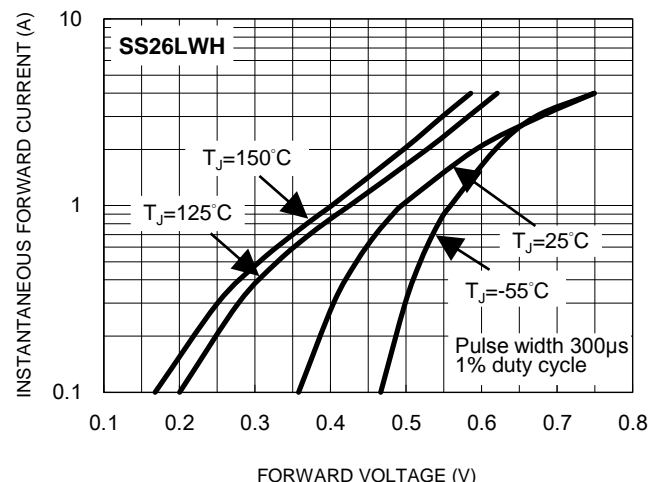
**Fig.4 Typical Forward Characteristics**



**Fig.5 Typical Reverse Characteristics**



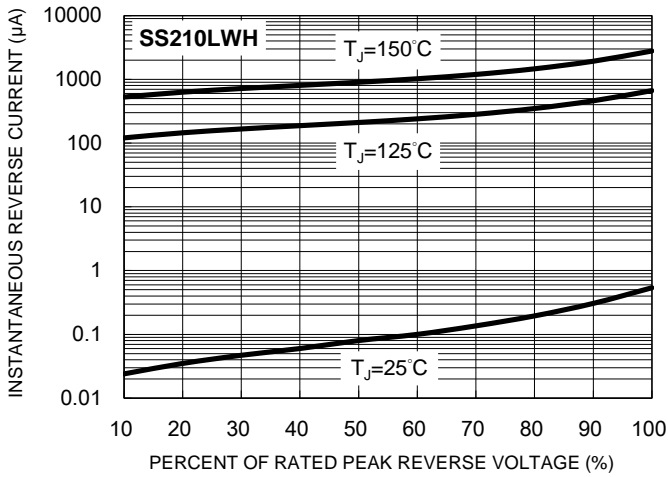
**Fig.6 Typical Forward Characteristics**



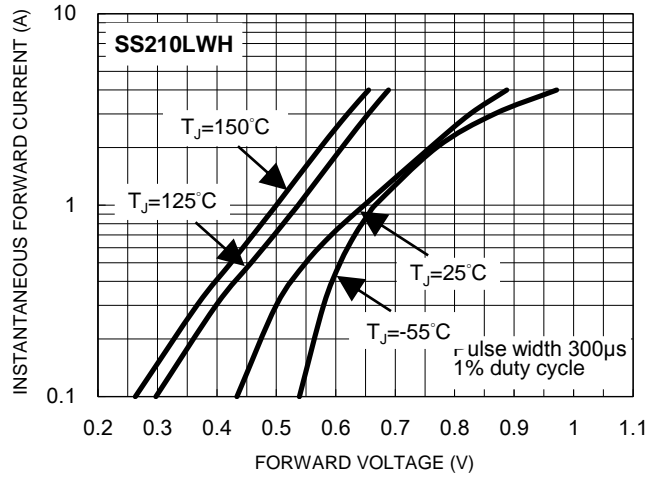
**CHARACTERISTICS CURVES**

( $T_A = 25^\circ\text{C}$  unless otherwise noted)

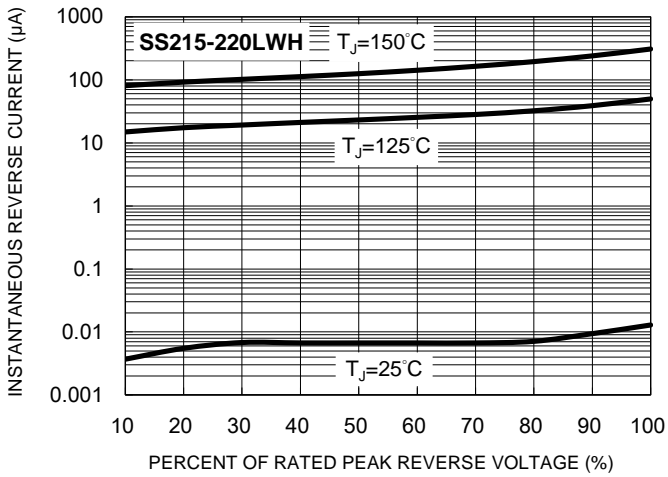
**Fig.7 Typical Reverse Characteristics**



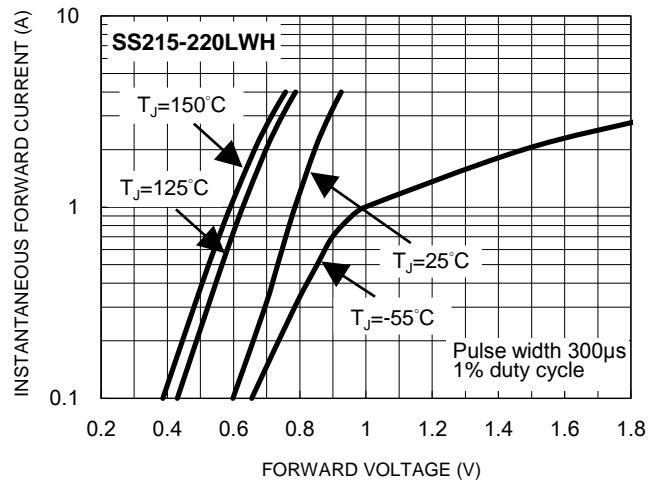
**Fig.8 Typical Forward Characteristics**



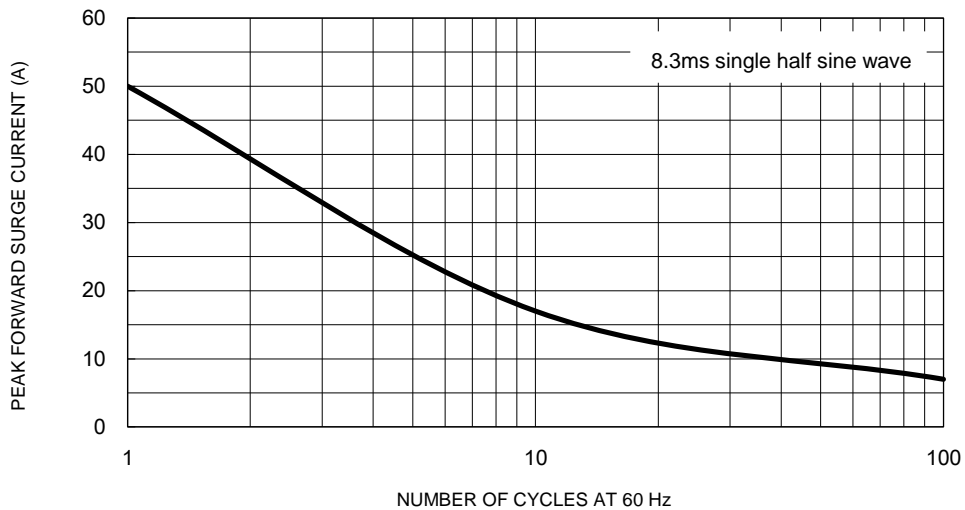
**Fig.9 Typical Reverse Characteristics**



**Fig.10 Typical Forward Characteristics**

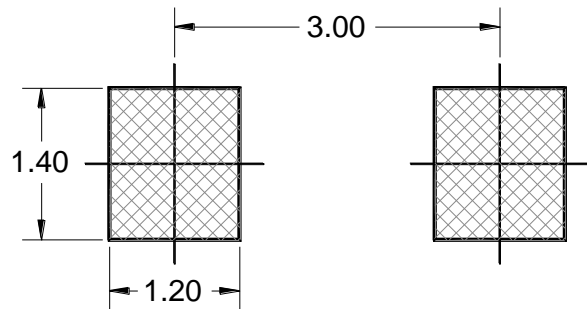
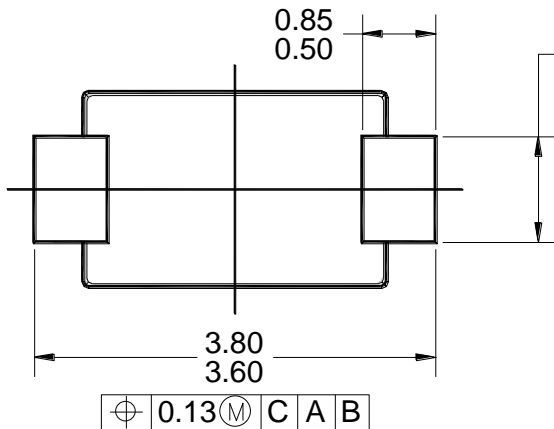
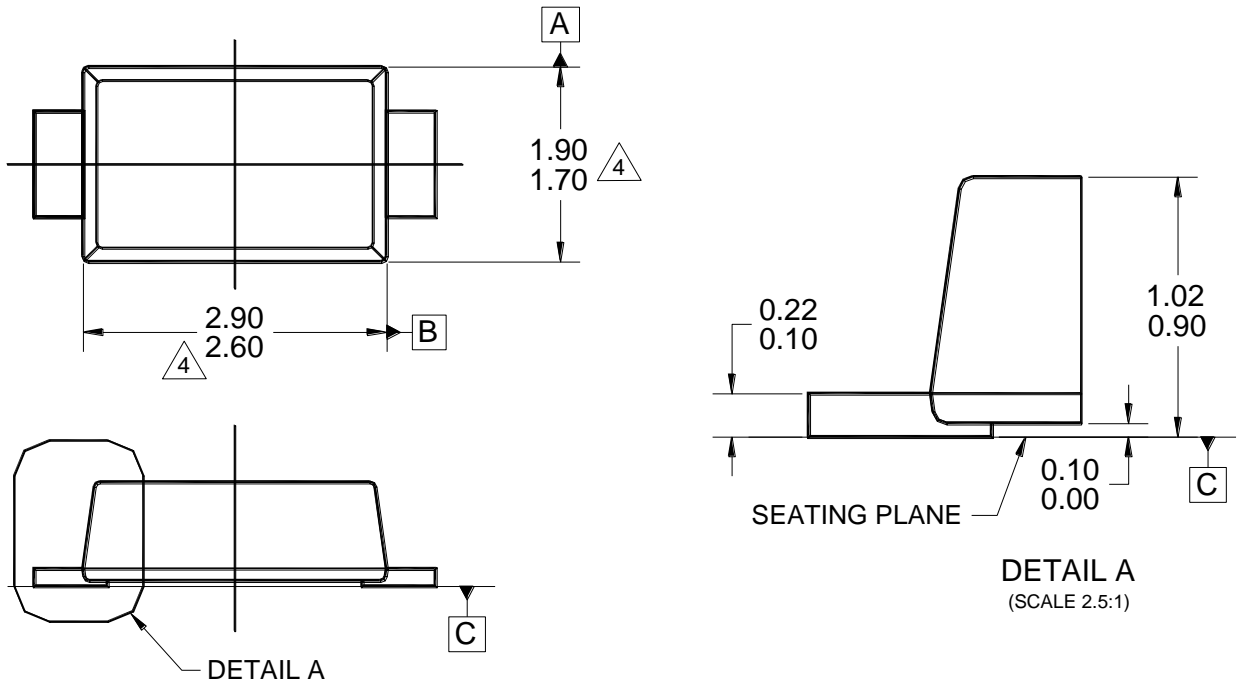


**Fig.11 Maximum Non-Repetitive Forward Surge Current**

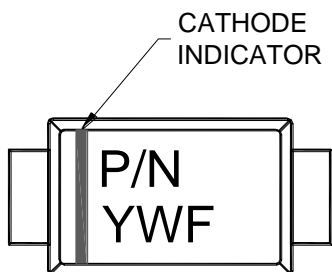


**PACKAGE OUTLINE DIMENSIONS**

**SOD-123W**



**SUGGESTED PAD LAYOUT**



**MARKING DIAGRAM**

**P/N** = MARKING CODE  
**YW** = DATE CODE  
**F** = FACTORY CODE

**NOTES: UNLESS OTHERWISE SPECIFIED**

1. ALL DIMENSIONS ARE IN MILLIMETERS.
2. DIMENSIONING AND TOLERANCING PER ASME Y14.5M-2009.
3. PACKAGE OUTLINE REFERENCE: JEDEC DO-219, VARIATION AB, ISSUE C.
4. MODIFIED PLASTIC BODY DIMENSIONS DO NOT INCLUDE MOLD FLASH.
5. DWG NO. REF: HQ2SD07-SOD123W-037 REV A.

## **Notice**

Specifications of the products displayed herein are subject to change without notice. TSC or anyone on its behalf assumes no responsibility or liability for any errors or inaccuracies.

Purchasers are solely responsible for the choice, selection, and use of TSC products and TSC assumes no liability for application assistance or the design of Purchasers' products.

Information contained herein is intended to provide a product description only. No license, express or implied, to any intellectual property rights is granted by this document. Except as provided in TSC's terms and conditions of sale for such products, TSC assumes no liability whatsoever, and disclaims any express or implied warranty, relating to sale and/or use of TSC products including liability or warranties relating to fitness for a particular purpose, merchantability, or infringement of any patent, copyright, or other intellectual property right.

The products shown herein are not designed for use in medical, life-saving, or life-sustaining applications. Customers using or selling these products for use in such applications do so at their own risk and agree to fully indemnify TSC for any damages resulting from such improper use or sale.