

Features

1 Pole - 6 A electromechanical relay interface modules, 6.2 mm wide.

Ideal interface for PLC and electronic systems

- Sensitive DC coil or AC/DC coil versions
- Integral coil indication and protection circuit
- Instant ejection of relay using plastic retaining clip
- UL Listing (certain relay/socket combinations)
- 35 mm rail (EN 50022) mounting

38.51 / 38.51.3
Screw terminal

38.61 / 38.61.3
Screwless terminal



* Special version for max ambient temperature +70°C.

For outline drawing see page 8

Contact specification

Contact configuration		1 CO (SPDT)
Rated current/Maximum peak current	A	6/10
Rated voltage/Maximum switching voltage V AC		250/400
Rated load AC1	VA	1,500
Rated load AC15 (230 V AC)	VA	300
Single phase motor rating (230 V AC)	kW	0.185
Breaking capacity DC1: 30/110/220 V	A	6/0.2/0.15
Minimum switching load	mW (V/mA)	500 (12/10)
Standard contact material		AgNi

Coil specification

Nominal voltage (U _N)	V AC/DC	12 - 24 - 48 - 60 - (110...125) - (220...240)
	V AC	(230...240)*
	V DC	6 - 12 - 24 - 48 - 60 (non polarized)
Rated power AC/DC	VA (50 Hz)/W	See page 7
Operating range	AC/DC	(0.8...1.1)U _N
	AC	(184...264)V
	DC	(0.8...1.2)U _N
Holding voltage	AC/DC	0.6 U _N / 0.6 U _N
Must drop-out voltage	AC/DC	0.1 U _N / 0.05 U _N

Technical data

Mechanical life AC/DC	cycles	10 · 10 ⁶
Electrical life at rated load AC1	cycles	60 · 10 ³
Operate/release time	ms	5/6
Insulation between coil and contacts (1.2/50 μs)	kV	6 (8 mm)
Dielectric strength between open contacts V AC		1,000
Ambient temperature range (U _N ≤ 60 V / >60V)	°C	-40...+70 / -40...+55
Protection category		IP 20

Approvals relay (according to type)

38.51/61



- 1 pole electromechanical relay
- Screw terminal and screwless terminal
- 35 mm rail (EN 50022) mounting

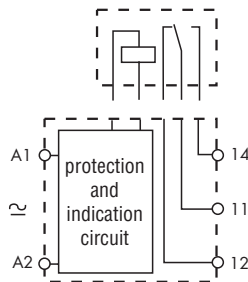

38.51.3 / 38.61.3



- 1 pole electromechanical relay
- Leakage current suppression
- Screw terminal and screwless terminal
- 35 mm rail (EN 50022) mounting

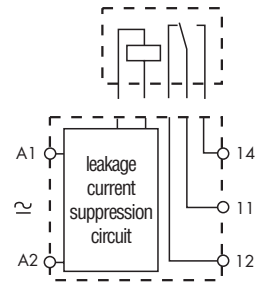

Features

2 Pole - 8 A electromechanical relay interface modules, 14 mm wide.

Ideal interface for PLC and electronic systems

- Sensitive DC coil or AC/DC coil versions
- Integral coil indication and protection circuit
- Instant ejection of relay using plastic retaining clip
- UL Listing (certain relay/socket combinations)
- 35 mm rail (EN 50022) mounting

38.52
Screw terminal



38.62
Screwless terminal



38.52



- 2 pole electromechanical relay
- Screw terminal
- 35 mm rail (EN 50022) mounting

38.62



- 2 pole electromechanical relay
- Screwless terminal
- 35 mm rail (EN 50022) mounting

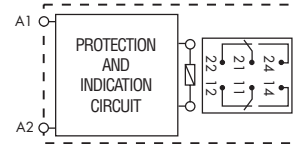
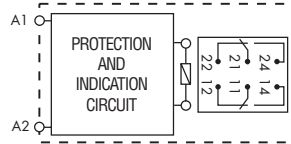

For outline drawing see page 8

Contact specification

Contact configuration		2 CO (DPDT)	2 CO (DPDT)
Rated current/Maximum peak current	A	8/15	8/15
Rated voltage/Maximum switching voltage	V AC	250/400	250/400
Rated load AC1	VA	2,000	2,000
Rated load AC15 (230 V AC)	VA	400	400
Single phase motor rating (230 V AC)	kW	0.3	0.3
Breaking capacity DC1: 30/110/220 V	A	8/0.3/0.12	8/0.3/0.12
Minimum switching load	mW (V/mA)	300 (5/5)	300 (5/5)
Standard contact material		AgNi	AgNi

Coil specification

Nominal voltage (U_N)	V AC/DC	24 - 60 - (110...125) - (220...240)	
	V DC	12 - 24 - 60	12 - 24 - 60
Rated power AC/DC	VA (50 Hz)/W	See page 7	See page 7
Operating range	AC/DC	0.8...1.1	0.8...1.1
	DC	$(0.8...1.2)U_N$	$(0.8...1.2)U_N$
Holding voltage	AC/DC	0.6 / 0.6 U_N	0.6 / 0.6 U_N
Must drop-out voltage	AC/DC	0.1 / 0.05 U_N	0.1 / 0.05 U_N

Technical data

Mechanical life AC/DC	cycles	$30 \cdot 10^6$	$30 \cdot 10^6$
Electrical life at rated load AC1	cycles	$80 \cdot 10^3$	$80 \cdot 10^3$
Operate/release time	ms	8 / 10	8 / 10
Insulation between coil and contacts (1.2/50 μ s)	kV	6 (8 mm)	6 (8 mm)
Dielectric strength between open contacts	V AC	1,000	1,000
Ambient temperature range ($U_N \leq 60$ V / >60 V)	°C	-40...+70 / -40...+55	-40...+70 / -40...+55
Protection category		IP 20	IP 20

Approvals relay (according to type)



Features

Single output - solid state relay interface modules, 6.2 mm wide

Ideal interface for PLC and electronic systems

- DC, AC or AC/DC input versions
- Supplied with integral coil indication and protection circuit
- Silent, high switching speed and long electrical life
- Instant ejection of relay using plastic retaining clip
- UL Listing (certain relay/socket combinations)
- 35 mm rail (EN 50022) mounting

38.81/38.91



- AC or DC output switching
- SSR relay - DC input voltage
- Screw terminal and screwless terminal
- 35 mm rail (EN 50022) mounting

38.81.3/38.91.3



- AC or DC output - Leakage current suppression
- SSR relay - AC or AC/DC input voltage
- Screw terminal and screwless terminal
- 35 mm rail (EN 50022) mounting

38.81 / 38.81.3
Screw terminal



38.91 / 38.91.3
Screwless terminal

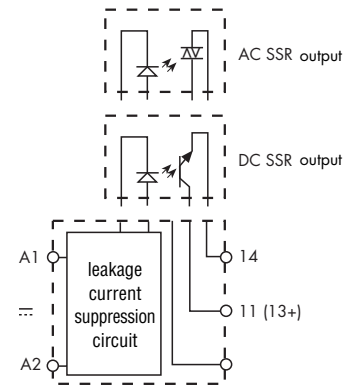
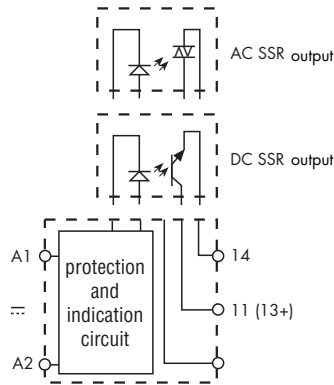

For outline drawing see page 8

Output circuit		38.81/38.91			38.81.3/38.91.3		
Rated current/Maximum peak current (10 ms)	A	2/20	0.1/0.5	2/40	2/20	0.1/0.5	2/40
Rated voltage/Maximum blocking voltage	V	24/33 DC	48/60 DC	240/275 AC	24/33 DC	48/60 DC	240/275 AC
Switching voltage range	V	(1.5...24)DC	(1.5...48)DC	(12...240)AC	(1.5...24)DC	(1.5...48)DC	(12...240)AC
Minimum switching current	mA	1	0.05	22	1	0.05	22
Max. "OFF-state" leakage current	mA	0.001	0.001	1.5	0.001	0.001	1.5
Max. "ON-state" voltage drop	V	0.12	1	1.6	0.12	1	1.6
Input circuit		38.81/38.91			38.81.3/38.91.3		
	V AC	—			230...240		
Nominal voltage (U _N)	V DC	6 - 24 - 60			—		
	V AC/DC	(110...125) - (220...240)			110...125		
Operating range	V DC	See page 8			See page 8		
Control current	mA	See page 8			See page 8		
Release voltage	V DC	See page 8			See page 8		
Technical data		38.81/38.91			38.81.3/38.91.3		
Operate/release time: ON/OFF (DC input)	ms	0.1/0.4	0.02/0.11	12/12	0.1/0.4	0.02/0.11	12/12
Dielectric strength between input/output	V	2,500			2,500		
Ambient temperature range	°C	-20...+55			-20...+55		
Environmental protection		IP20			IP20		
Approvals relay (according to type)							

Electromechanical Relay

Ordering information

Electromechanical relay - 1 Pole

Example: 38 series screw terminal relay interface module, 1 CO (SPDT), sensitive 12 V DC coil.

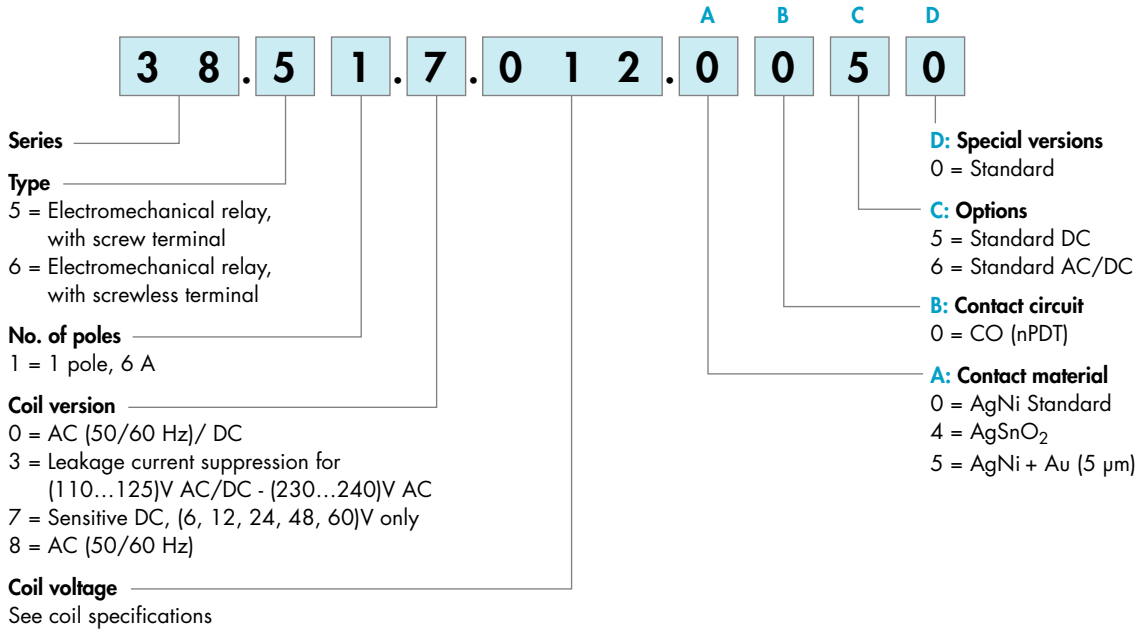

Electromechanical relay - 2 Pole

Example: 38 series screw terminal relay interface module, 2 CO (DPDT), sensitive 12 V DC coil.

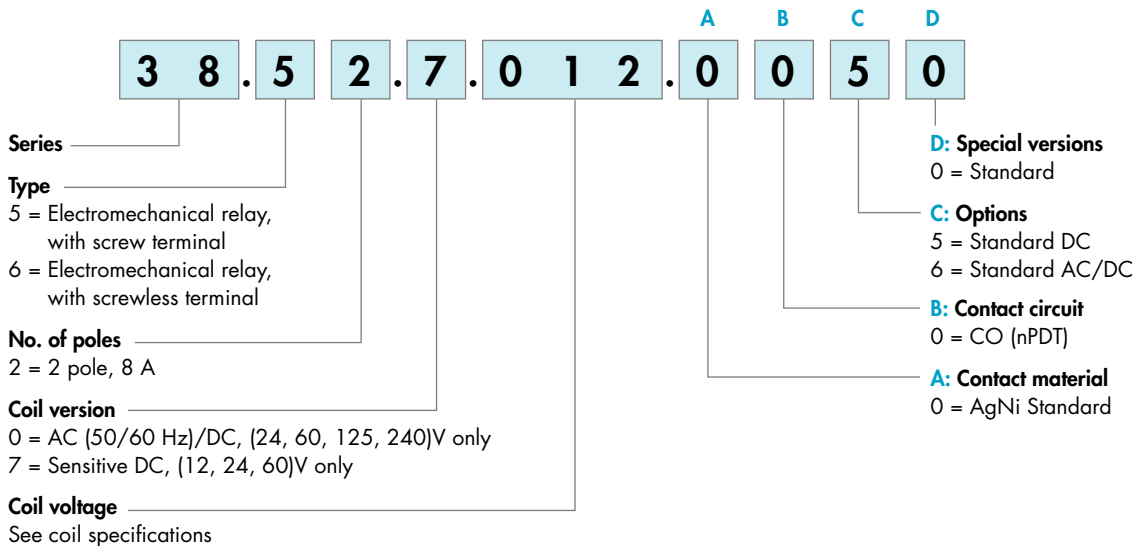

Solid State Relay

Ordering information

Solid state relay

Example: 38 series screw terminal SSR relay interface module, 2 A, 24 V DC supply.



Series _____

Type _____
 8 = SSR relay, with screw terminal
 9 = SSR relay, with screwless terminal

Output _____
 1 = 1 NO (SPST-NO)

Supply version _____
 0 = AC/DC for (110...125)V and (220...240)V only
 3 = Leakage current suppression for
 (110...125)V AC/DC and (230...240)V AC
 7 = DC, (6, 24, 60)V only

Supply voltage _____
 See input specifications

Output circuit
 9024 = 2 A - 24 V DC
 7048 = 0.1 A - 48 V DC
 8240 = 2 A - 240 V AC

Electromechanical Relay

Technical data

Insulation				
Insulation according to EN 61810-1	insulation rated voltage	V	250	400
	rated impulse withstand voltage	kV	4	4
	pollution degree		3	2
	overvoltage category		III	III
Insulation between coil and contacts (1.2/50 μ s)		kV	6 (8 mm)	
Dielectric strength between open contacts		V AC	1,000	
Conducted disturbance immunity				
Burst (5...50)ns, 5 kHz, on A1 - A2			EN 61000-4-4	level 4 (4 kV)
Surge (1.2/50 μ s) on A1 - A2 (differential mode)			EN 61000-4-5	level 3 (2 kV)
Other data			1 Pole	2 Pole
Bounce time: NO/NC		ms	1/6	2/5
Vibration resistance (10...55)Hz: NO/NC		g	10/5	15/2
Power lost to the environment	without contact current	W	0.2 (12 V) - 0.9 (240 V)	
	with rated current	W	0.5 (12 V) - 1.5 (240 V)	
			38.51/52	38.61/62
Wire strip length		mm	10	
⊖ Screw torque		Nm	0.5	
Max. wire size			solid cable	stranded cable
		mm ²	1x2.5/2x1.5	1x2.5
		AWG	1x14/2x16	1x14
			1x14/2x16	1x14

Contact specification

F 38 - Electrical life (AC) v contact current, 1 Pole

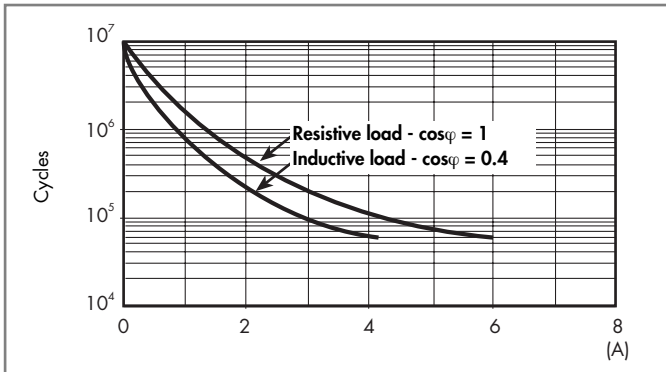

H 38 - Maximum DC1 breaking capacity, 1 Pole

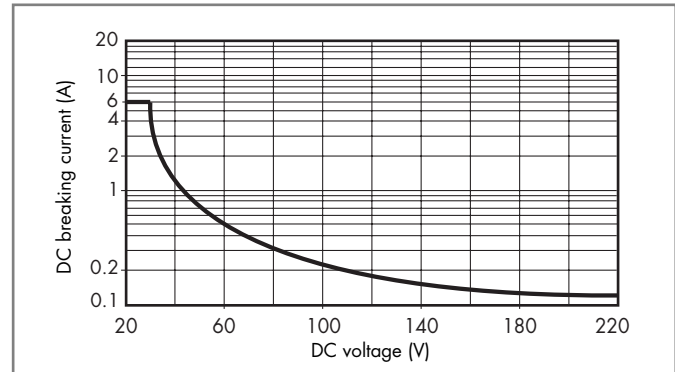

F 38 - Electrical life (AC) v contact current, 2 Pole

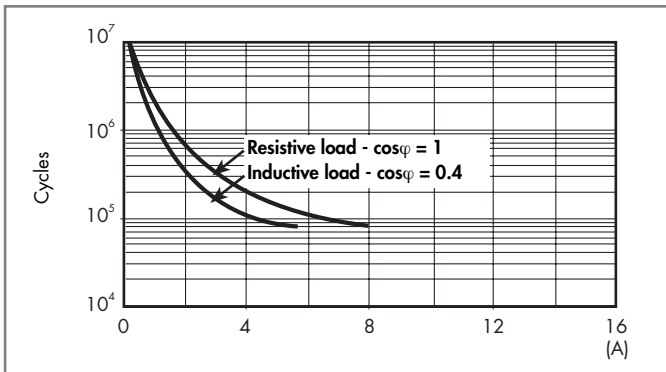

H 38 - Maximum DC1 breaking capacity, 2 Pole

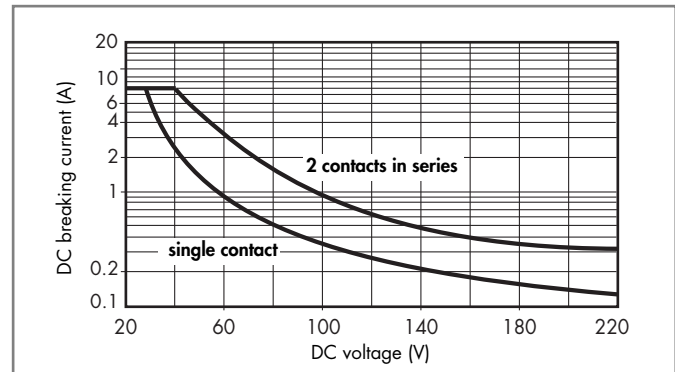

- When switching a resistive load (DC1) having voltage and current values under the curve, an electrical life of $\geq 60 \cdot 10^3$ (1 Pole) or $\geq 80 \cdot 10^3$ (2 Pole) can be expected.
- In the case of DC13 loads, the connection of a diode in parallel with the load will permit a similar electrical life as for a DC1 load. Note: the release time for the load will be increased.

Electromechanical Relay 1 Pole

Coil specifications

Coil data sensitive DC, 1 Pole

Nominal voltage U_N	Coil code	Operating range		Rated coil consumption I at U_N	Power consumption P at U_N
		U_{min}	U_{max}		
V		V	V	mA	W
6	7.006	4.8	7.2	35	0.2
12	7.012	9.6	14.4	15.2	0.2
24	7.024	19.2	28.8	10.4	0.3
48	7.048	38.4	57.6	6.3	0.3
60	7.060	48	72	7	0.4

Coil data AC/DC, 1 Pole

Nominal voltage U_N	Coil code	Operating range		Rated coil consumption I at U_N	Power consumption P at U_N
		U_{min}	U_{max}		
V		V	V	mA	VA/W
12	0.012	9.6	13.2	16	0.2/0.2
24	0.024	19.2	26.4	12	0.3/0.2
48	0.048	38.4	52.8	6.9	0.3/0.3
60	0.060	48	66	7	0.5/0.5
110...125	0.125	88	138	5(*)	0.6/0.6(*)
220...240	0.240	176	264	4(*)	1/0.9(*)

(*) Rated coil consumption and power consumption values relate to $U_N = 125$ and 240 V.

Coil data AC, indicated for max ambient temperature +70°C

Nominal voltage U_N	Coil code	Operating range		Rated coil consumption I at U_N	Power consumption P at U_N
		U_{min}	U_{max}		
V		V	V	mA	VA/W
(230...240) AC	8.240	184	264	3	0.7/0.3

Coil data, leakage current suppression types, 1 Pole

Nominal voltage U_N	Coil code	Operating range		Rated coil consumption I at U_N	Power consumption P at U_N
		U_{min}	U_{max}		
V		V	V	mA	VA/W
(110...125) AC/DC	3.125	94	138	8(*)	1/1(*)
(230...240) AC	3.240	184	264	7(*)	1.7/0.5(*)

(*) Rated coil consumption and power consumption values relate to $U_N = 125$ and 240 V.

The 38 Series interface modules (supply version 3) have built-in leakage current suppression to address industry concerns of the contacts not dropping-out when there is residual current in the circuit; at (110...125)V AC and (230...240)V AC.

This problem can occur, for example, when connecting the interface modules to PLC,s with triac outputs or when connecting via relatively long cables.

Electromechanical Relay 2 Pole

Coil specifications

Coil data sensitive DC, 2 Pole

Nominal voltage U_N	Coil code	Operating range		Rated coil consumption I at U_N	Power consumption P at U_N
		U_{min}	U_{max}		
V		V	V	mA	W
12	7.012	9.6	14.4	41	0.5
24	7.024	19.2	28.8	19.5	0.5
60	7.060	48	72	8	0.5

Coil data AC/DC

Nominal voltage U_N	Coil code	Operating range		Rated coil consumption I at U_N	Power consumption P at U_N
		U_{min}	U_{max}		
V		V	V	mA	VA/W
24	0.024	19.2	26.4	20	0.5/0.5
60	0.060	48	66	7.1	0.5/0.5
110...125	0.125	88	138	4.6	0.6/0.6
220...240	0.240	184	264	3.8	0.9/0.9

R 38 - DC coil operating range v ambient temperature 1 Pole and 2 Pole

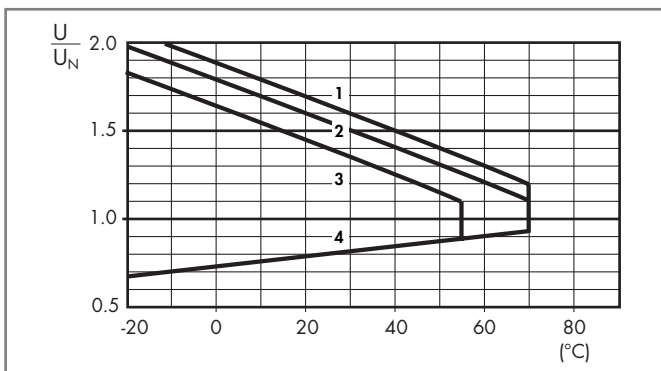

- 1 - Max. permitted coil voltage at nominal load (DC coil).
- 2 - Max. permitted coil voltage at nominal load (AC/DC coils $U \leq 60$ V).
- 3 - Max. permitted coil voltage at nominal load (AC/DC coils $U > 60$ V).
- 4 - Min pick-up voltage with coil at ambient temperature.

Solid State Relay

Technical data

Other data				
Power lost to the environment	without output current	W	0.25 (24 V DC)	
	with rated current	W	0.4	
			38.81	38.91
Wire strip length		mm	10	10
Screw torque		Nm	0.5	—
Max. wire size		solid cable	stranded cable	solid cable
		mm ²	1x2.5 / 2x1.5	1x2.5
		AWG	1x14 / 2x16	1x14

Input specification

Input data DC

Nominal voltage U_N	Supply code	Operating range		Release voltage U	Rated coil consumption I at U_N	Power consumption P
		U_{min}	U_{max}			
V		V	V	V	mA	W
6	7.006	5	7.2	2.4	7	0.2
24	7.024	16.8	30	10	10.5	0.3
60	7.060	35.6	72	20	6.5	0.4

Input data AC/DC

Nominal voltage U_N	Supply code	Operating range		Release voltage U	Rated coil consumption I at U_N	Power consumption P
		U_{min}	U_{max}			
V		V	V	V	mA	VA/W
110...125	0.125	88	138	22	5.5*	0.7/0.7
220...240	0.240	184	264	44	3.5*	1/0.9

(*) Rated coil consumption and power consumption values relate to $U_N = 125$ and 240 V.

Input data - Leakage current suppression types

Nominal voltage U_N	Supply code	Operating range		Release voltage U	Rated coil consumption I at U_N	Power consumption P at U_N
		U_{min}	U_{max}			
V		V	V	V	mA	W
110...125 AC/DC	3.125	94	138	44	8(*)	1/1(*)
230...240 AC	3.240	184	264	72	6.5(*)	1.6/0.6(*)

(*) Rated coil consumption and power consumption values relate to $U_N = 125$ and 240 V.

The 38 Series interface modules (supply version 3) have built-in leakage current suppression to address industry concerns of the contacts not dropping-out when there is residual current in the circuit; at (110...125)V AC and (230...240)V AC.

This problem can occur, for example, when connecting the interface modules to PLC,s with triac outputs or when connecting via relatively long cables.

Outline drawing

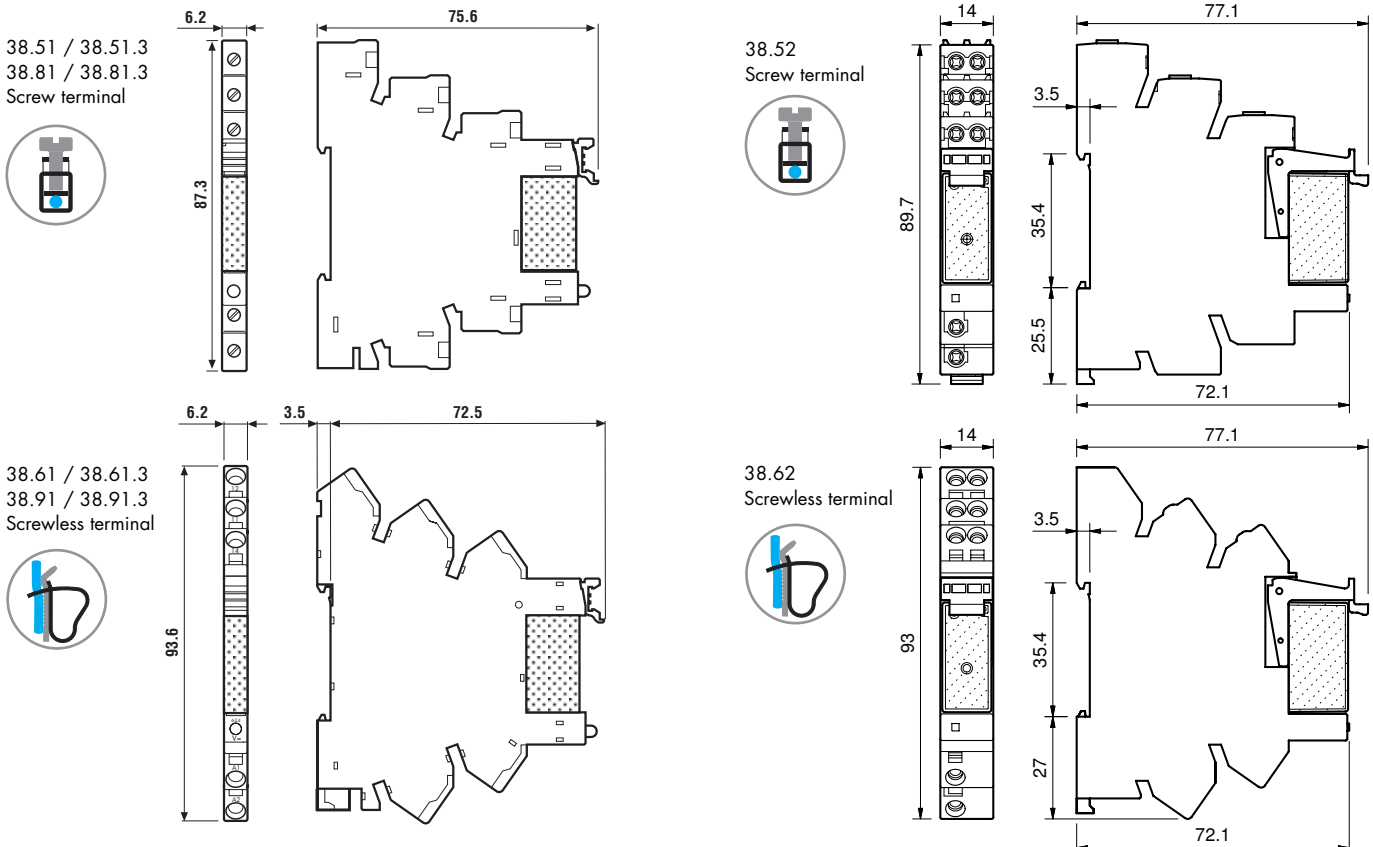

Combination for Electromechanical Relay

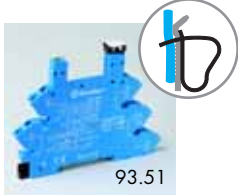
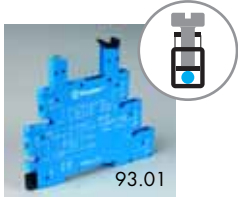

Approvals
(according to type):



Certain relay/socket combinations

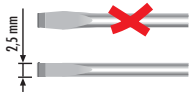

Screw terminal - 1 Pole relay			
Code	Supply voltage	Type of relay	Type of socket
38.51.0.012.0060	12 V AC/DC	34.51.7.012.0010	93.01.0.024
38.51.0.024.0060	24 V AC/DC	34.51.7.024.0010	93.01.0.024
38.51.0.048.0060	48 V AC/DC	34.51.7.048.0010	93.01.0.060
38.51.0.060.0060	60 V AC/DC	34.51.7.060.0010	93.01.0.060
38.51.0.125.0060	(110...125)V AC/DC	34.51.7.060.0010	93.01.0.125
38.51.0.240.0060	(220...240)V AC/DC	34.51.7.060.0010	93.01.0.240
38.51.3.125.0060	(110...125)V AC/DC	34.51.7.060.0010	93.01.3.125
38.51.3.240.0060	(230...240)V AC	34.51.7.060.0010	93.01.3.240
38.51.7.006.0050	6 V DC	34.51.7.005.0010	93.01.7.024
38.51.7.012.0050	12 V DC	34.51.7.012.0010	93.01.7.024
38.51.7.024.0050	24 V DC	34.51.7.024.0010	93.01.7.024
38.51.7.048.0050	48 V DC	34.51.7.048.0010	93.01.7.060
38.51.7.060.0050	60 V DC	34.51.7.060.0010	93.01.7.060
38.51.8.240.0060	(230...240)V AC	34.51.7.060.0010	93.01.8.240

Screwless terminal - 1 Pole relay			
Code	Supply voltage	Type of relay	Type of socket
38.61.0.012.0060	12 V AC/DC	34.51.7.012.0010	93.51.0.024
38.61.0.024.0060	24 V AC/DC	34.51.7.024.0010	93.51.0.024
38.61.0.125.0060	(110...125)V AC/DC	34.51.7.060.0010	93.51.0.125
38.61.0.240.0060	(220...240)V AC/DC	34.51.7.060.0010	93.51.0.240
38.61.3.125.0060	(110...125)V AC/DC	34.51.7.060.0010	93.51.3.125
38.61.3.240.0060	(230...240)V AC	34.51.7.060.0010	93.51.3.240
38.61.7.012.0050	12 V DC	34.51.7.012.0010	93.51.7.024
38.61.7.024.0050	24 V DC	34.51.7.024.0010	93.51.7.024
38.61.8.240.0060	(230...240)V AC	34.51.7.060.0010	93.51.8.240

Screw terminal - 2 Pole relay			
Code	Supply voltage	Type of relay	Type of socket
38.52.0.024.0060	24 V AC/DC	41.52.9.024.0010	93.02.0.024
38.52.0.060.0060	60 V AC/DC	41.52.9.060.0010	93.02.0.060
38.52.0.125.0060	(110...125)V AC/DC	41.52.9.110.0010	93.02.0.125
38.52.0.240.0060	(220...240)V AC/DC	41.52.9.110.0010	93.02.0.240
38.52.7.012.0050	12 V DC	41.52.9.012.0010	93.02.7.024
38.52.7.024.0050	24 V DC	41.52.9.024.0010	93.02.7.024
38.52.7.060.0050	60 V DC	41.52.9.060.0010	93.02.7.060

Screwless terminal - 2 Pole relay			
Code	Supply voltage	Type of relay	Type of socket
38.62.0.024.0060	24 V AC/DC	41.52.9.024.0010	93.52.0.024
38.62.0.060.0060	60 V AC/DC	41.52.9.060.0010	93.52.0.060
38.62.0.125.0060	(110...125)V AC/DC	41.52.9.110.0010	93.52.0.125
38.62.0.240.0060	(220...240)V AC/DC	41.52.9.110.0010	93.52.0.240
38.62.7.012.0050	12 V DC	41.52.9.012.0010	93.52.7.024
38.62.7.024.0050	24 V DC	41.52.9.024.0010	93.52.7.024
38.62.7.060.0050	60 V DC	41.52.9.060.0010	93.52.7.060

Combination for Solid State Relay

Screw terminal			
Code	Supply voltage	Type of relay	Type of socket
38.81.7.006.xxxx	6 V DC	34.81.7.005.xxxx	93.01.7.024
38.81.7.024.xxxx	24 V DC	34.81.7.024.xxxx	93.01.7.024
38.81.7.060.xxxx	60 V DC	34.81.7.060.xxxx	93.01.7.060
38.81.0.125.xxxx	(110...125)V AC/DC	34.81.7.060.xxxx	93.01.0.125
38.81.0.240.xxxx	(220...240)V AC/DC	34.81.7.060.xxxx	93.01.0.240
38.81.3.125.xxxx	(110...125)V AC/DC	34.81.7.060.xxxx	93.01.3.125
38.81.3.240.xxxx	(230...240)V AC	34.81.7.060.xxxx	93.01.3.240

Screwless terminal			
Code	Supply voltage	Type of relay	Type of socket
38.91.7.006.xxxx	6 V DC	34.81.7.005.xxxx	93.51.7.024
38.91.7.024.xxxx	24 V DC	34.81.7.024.xxxx	93.51.7.024
38.91.7.060.xxxx	60 V DC	34.81.7.060.xxxx	93.51.7.060
38.91.0.125.xxxx	(110...125)V AC/DC	34.81.7.060.xxxx	93.51.0.125
38.91.0.240.xxxx	(220...240)V AC/DC	34.81.7.060.xxxx	93.51.0.240
38.91.3.125.xxxx	(110...125)V AC/DC	34.81.7.060.xxxx	93.51.3.125
38.91.3.240.xxxx	(230...240)V AC	34.81.7.060.xxxx	93.51.3.240

Example: .xxxx
.9024
.7048
.8240

Accessories

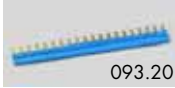

093.20

Approvals
(according to type):



20-way jumper link for 38.x1	093.20 (blue)
Rated values	36 A - 250 V

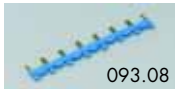
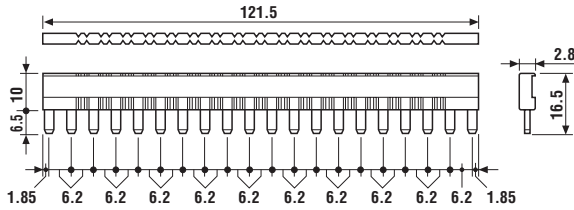

093.08

Approvals
(according to type):



8-way jumper link for 38.x2	093.08 (blue)
Rated values	10 A - 250 V

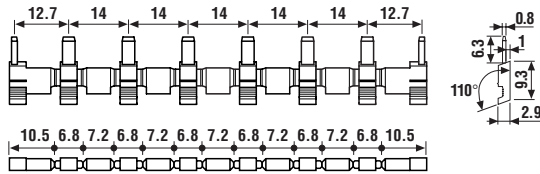

093.01

Plastic separator	093.01
Thickness 2 mm, required at the start and the end of a group of interfaces. Can be used for visual separation group, must be used for: - protective separation of different voltages of neighbouring PLC interfaces according to VDE 0106-101 - protection of cut jumper links	



093.64

Sheet of marker tags for 38.x1, plastic, 64 tags, 6x10 mm	093.64
--	--------



060.72

Sheet of marker tags for 38.x2, plastic, 72 tags, 6x12 mm	060.72
--	--------