



Ordering No.: HS-656  
(Water-Cooling Plate)



## Features

- High voltage output(115/230/380V DC)
- Slim and Low profile (60mm)
- Fanless design with water or conduction cooling
- Active PFC design and efficiency up to 96%
- Built-in PMBus communication protocol, CANbus optional
- Output voltage and constant current level programmable
- Protections: Short circuit / Overload / Over voltage / Over temperature
- Built-in remote ON/OFF control and DC-OK active signal
- Optional water-cooling plate for quick installation
- OVC III operating altitude up to 2000 meter
- LED indicator for power on
- 5 years warranty

## Applications

- Industrial automation machinery
- Industrial control system
- Mechanical and electrical equipments
- Electronic instruments, equipments
- Laser equipments
- Household appliances
- Charging system
- Electrolysis system
- DC centralized bus

## Description

PHP-3500-HV series is a 3500W single-output slim type power supply with 60mm of low profile design. Adopting the full range 90~264VAC input, the entire series provides an output voltage line of 115V, 230V and 380VDC. In addition to the high efficiency up to 96%, that the whole series operates from -30°C ~ +70°C under water cooling. PHP-3500-HV has the complete protection functions and 2G anti-vibration capability; it complies with the international safety regulations such as TUV BS EN/EN62368-1, UL62368-1, and design refers to BS EN/EN61558-1 and BS EN/EN60335-1. PHP-3500-HV series serves as a high performance power supply solution for various industrial and DC centralized bus applications.

## Model Encoding

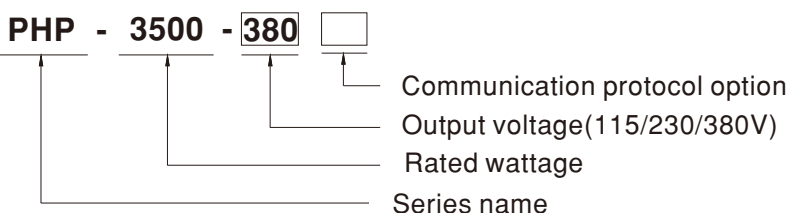

Type	Communication Protocol	Note
Blank	PMBus protocol	In Stock
CAN	CANBus protocol	By request

**SPECIFICATION**

MODEL	PHP-3500-115	PHP-3500-230	PHP-3500-380	
OUTPUT	DC VOLTAGE	115V	230V	380V
	CURRENT (Factory default)	25.2A	15.2A	9.2A
	RATED CURRENT(Max.)	26.3A	16.1A	10.5A
	POWER (Factory default)	2898W	3500W	3500W
	RATED POWER(Max.) Note.11	3500W	3500W	3500W
	RIPPLE & NOISE (max.) Note.2	1.15Vp-p	2.3Vp-p	3.8Vp-p
	VOLTAGE ADJ. RANGE	By built-in potentiometer, SVR		
		110~160V	170~260V	260~400V
	VOLTAGE TOLERANCE Note.3	±1.0%	±1.0%	±1.0%
	LINE REGULATION	±0.5%	±0.5%	±0.5%
LOAD REGULATION	±0.5%	±0.5%	±0.5%	
SETUP, RISE TIME	2000ms, 60ms/230VAC at full load 2500ms, 60ms/115VAC at 60% load			
HOLD UP TIME (Typ.)	16ms/230VAC at 75% load 10ms/230VAC at full load 10ms/115VAC at 60% load			
INPUT	VOLTAGE RANGE Note.4	90 ~ 264VAC 127 ~ 370VDC		
	FREQUENCY RANGE	47 ~ 63Hz		
	POWER FACTOR (Typ.)	PF ≥ 0.95/230VAC at full load PF ≥ 0.95/115VAC at 60% load		
	EFFICIENCY (Peak) Note 10	95%	95.5%	96%
	AC CURRENT (Typ.)	20A/230VAC 21A/115VAC		
	INRUSH CURRENT (Typ.)	Cold start 80A/230VAC 40A/115VAC		
LEAKAGE CURRENT	2mA / 240VAC			
PROTECTION	OVERLOAD	105 ~ 115% rated output power Protection type : Constant current limiting, unit will shut down after 5 sec, re-power on to recover.		
	SHORT CIRCUIT	Protection type : Constant current limiting, unit will shut down after 5 sec, re-power on to recover.		
	OVER VOLTAGE	168 ~ 200V	273 ~ 320V	413 ~ 460V
	OVER TEMPERATURE	Protection type : Shut down O/P voltage, re-power on to recover		
FUNCTION	OUTPUT VOLTAGE PROGRAMMABLE(PV) Note 5,6	Adjustment of output voltage is allowable to 50~120% of nominal output voltage. Please refer to the function manual		
	OUTPUT CURRENT PROGRAMMABLE(PC) Note 6	Adjustment of constant current level is allowable to 20 ~ 100% of rated current. Please refer to the Function Manual.		
	REMOTE ON/OFF CONTROL	Power ON : Short circuit Power OFF : Open circuit		
	AUXILIARY POWER	12V@0.5A tolerance±10%, ripple 150mVp-p		
	DC-OK SIGNAL	The TTL signal out, PSU turn on = -0.5 ~ 0.5V ; PSU turn off = 3.5 ~ 5.5V. Please refer to the Function Manual.		
ENVIRONMENT	WORKING TEMP.	-30 ~ +70°C (Refer to "Derating Curve")		
	WORKING HUMIDITY	20 ~ 90% RH non-condensing		
	STORAGE TEMP., HUMIDITY	-40 ~ +85°C, 10 ~ 95% RH non-condensing		
	TEMP. COEFFICIENT	±0.03%/°C (0 ~ 50°C)		
	VIBRATION	10 ~ 500Hz, 2G 10min./1cycle, 60min. each along X, Y, Z axes		
	OVER VOLTAGE CATEGORY	III ; According to EN61558 ; altitude up to 2000 meters.		
SAFETY & EMC (Note.7,8)	SAFETY STANDARDS	UL62368-1, TUV BS EN/EN62368-1, EAC TP TC 004 approved ; design refers to BS EN/EN61558-1, BS EN/EN60335-1		
	WITHSTAND VOLTAGE	I/P-O/P:6KVDC I/P-FG:4KVDC O/P-FG:4KVDC		
	ISOLATION RESISTANCE	I/P-O/P, I/P-FG, O/P-FG:100M Ohms/500VDC/25°C / 70%RH		
	EMC EMISSION	Parameter	Standard	Test Level / Note
		Conducted	EN55032 (CISPR32)	Class B
		Radiated	EN55032 (CISPR32)	Class A
		Harmonic Current	EN61000-3-12	----
	EMC IMMUNITY	Parameter	Standard	Test Level / Note
		ESD	EN61000-4-2	Level 3, 8KV air ; Level 2, 4KV contact
		Radiated	EN61000-4-3	Level 3
EFT / Burst		EN61000-4-4	Level 3	
Surge		EN61000-6-2	2KV/Line-Line 4KV/Line-Earth	
Conducted		EN61000-4-6	Level 3	
Magnetic Field		EN61000-4-8	Level 4	
Voltage Dips and Interruptions		EN61000-4-11	>95% dip 0.5 periods, 30% dip 25 periods, >95% interruptions 250 periods	
OTHERS	MTBF	192.1K hrs min. 63.9Khrs MIL-HDBK-217F (25°C)		
	DIMENSION	380*141.4*60mm (L*W*H)		
	PACKING	4.5Kg;4pcs/19Kg/2.46CUFT		
NOTE	<p>1. All parameters NOT specially mentioned are measured at 230VAC input, rated load and 25°C of ambient temperature.</p> <p>2. Ripple &amp; noise are measured at 20MHz of bandwidth by using a 12" twisted pair-wire terminated with a 0.1uf &amp; 47uf parallel capacitor.</p> <p>3. Tolerance :includes set up tolerance, line regulation and load regulation.</p> <p>4. Derating may be needed under low input voltages. Please check the derating curve for more details.</p> <p>5. Without water or fan cooling to provide adequate heat dissipation, OTP might be triggered if trimming output voltage by PV signal toward upper or lower limits of nominal voltage. Under such condition, enhanced cooling on PSU is highly recommended.</p> <p>6. In the control priority on Vout and Iout trimming, Please refer to the table on page 9.</p> <p>7. Need additional EMI filter to meet regulations of EMC conducted and radiated emission. Characteristics of EMI filter please refer to the table, Minimum Insertion Loss.</p> <p>8. The power supply is considered a component which will be installed into a final equipment. All the EMC tests are been executed by mounting the unit on a 600mm*900mm metal plate with 1mm of thickness. The final equipment must be re-confirmed that it still meets EMC directives. For guidance on how to perform these EMC tests, please refer to "EMI testing of component power supplies." (as available on <a href="http://www.meanwell.com">http://www.meanwell.com</a>)</p> <p>9. The ambient temperature derating of 3.5°C/1000m with fanless models and of 5°C/1000m with fan models for operating altitude higher than 2000m(6500ft).</p> <p>10. The efficiency level is measured at output voltage: 133V (115V model)/ 217V (230V model)/ 333V (380V model).</p> <p>11. Refer to derating curve.</p> <p>※ Product Liability Disclaimer : For detailed information, please refer to <a href="https://www.meanwell.com/serviceDisclaimer.aspx">https://www.meanwell.com/serviceDisclaimer.aspx</a></p>			

## ■ BLOCK DIAGRAM

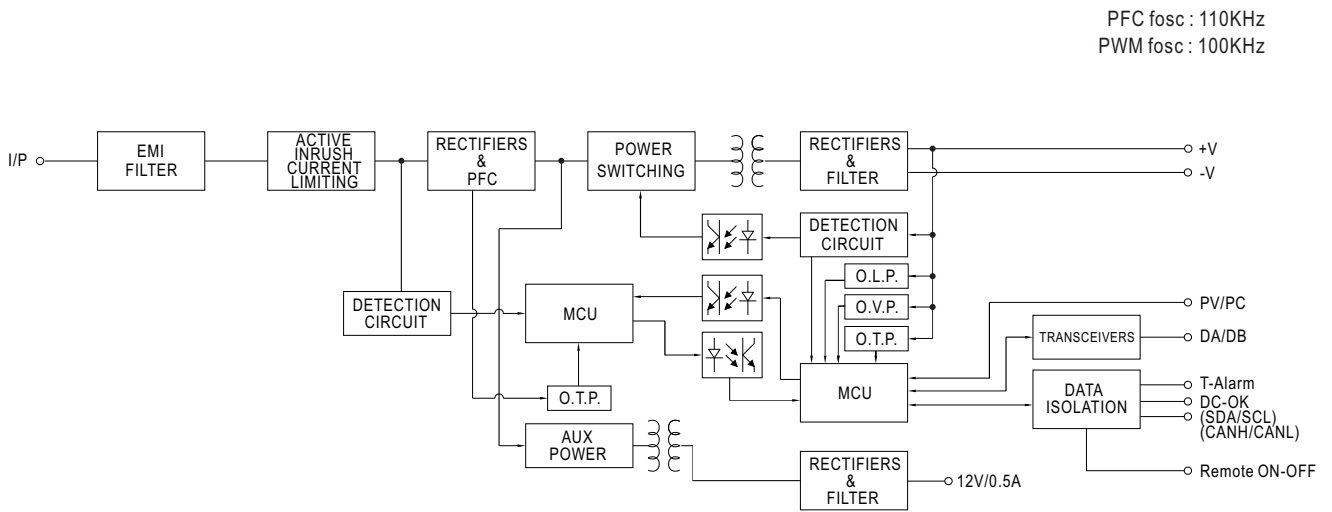

## ■ DERATING CURVE

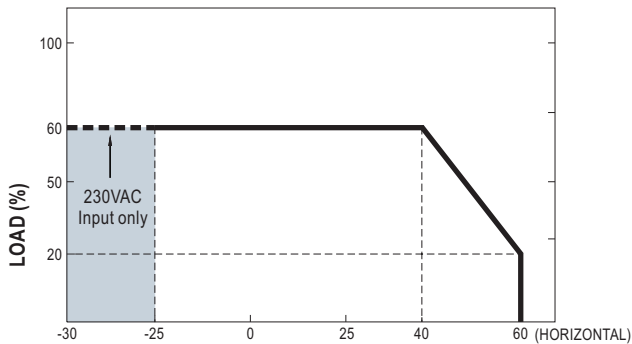

AMBIENT TEMPERATURE WITH ADDITIONAL ALUMINUM PLATE(°C)  
(450x450x3mm)

Note. Tcase max. ≤ 70°C and ambient temp must be within above de-rating curve.

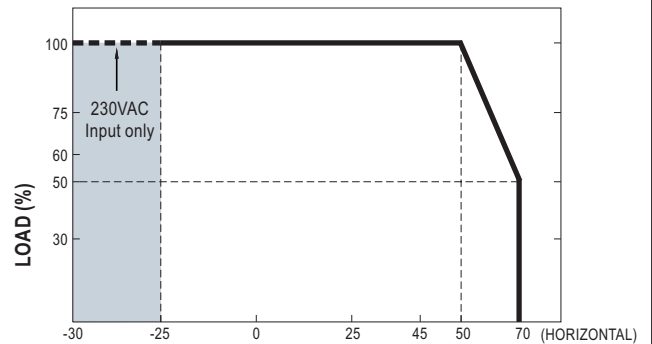

AMBIENT TEMPERATURE WITH 128 CFM FAN\*2 OR WATER COOLING SYSTEM (°C)

Note. Tcase max. ≤ 45°C and ambient temp must be within above de-rating curve.

## ■ STATIC CHARACTERISTICS

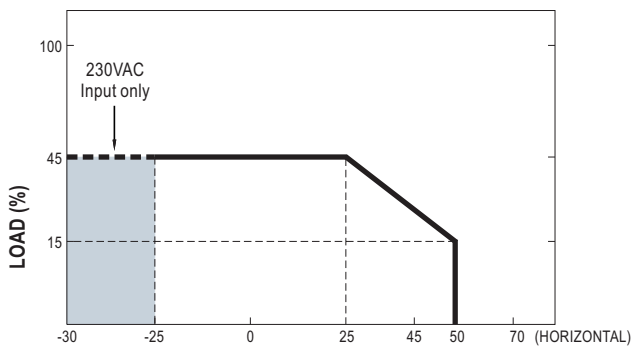

AMBIENT TEMPERATURE WITHOUT ALUMINUM PLATE(°C)

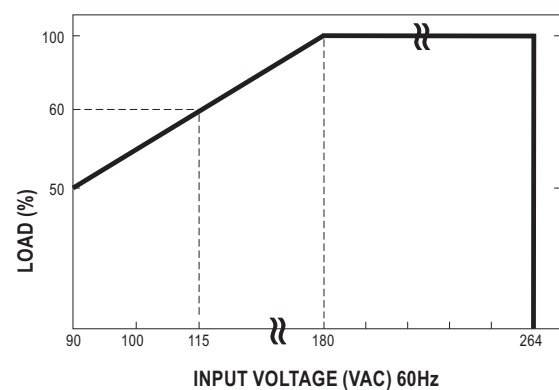

## FUNCTION MANUAL

### 1. Output Voltage Programming (or, PV / remote voltage programming / remote adjust / margin programming / dynamic voltage trim)

115V, 230V, 380V model

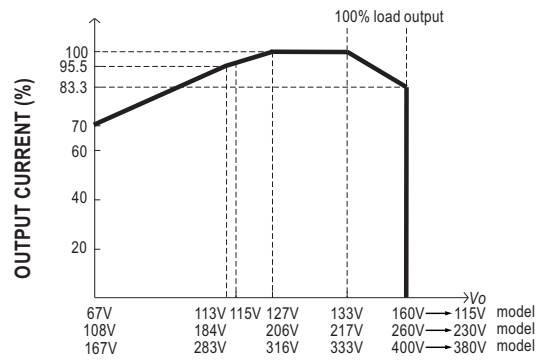
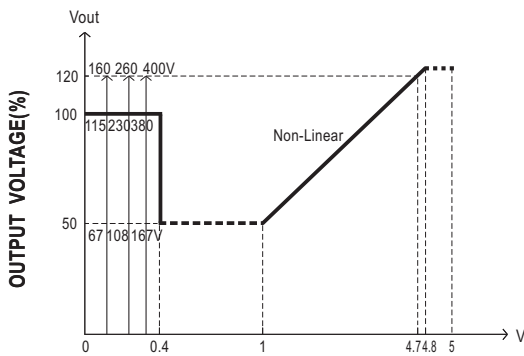
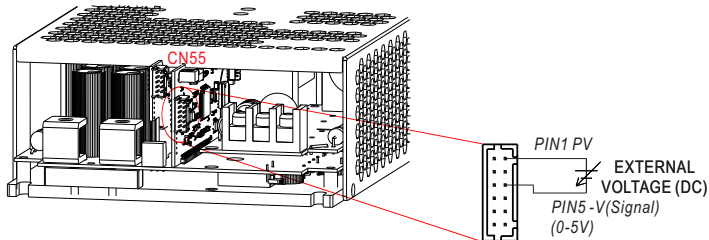

© The 100% output voltage is based on default.

© The rated current should change with the Output Voltage Programming accordingly.

## 2. Output Current Programming (or, PC / remote current programming / dynamic current trim)

※ The output current can be trimmed to 20~100% of the rated current by applying EXTERNAL VOLTAGE.

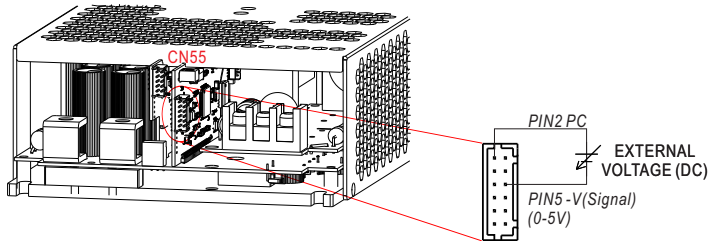

115V, 230V, 380V model

※ Covered by over temperature protection, auto de-rating function works under operation either in PC mode or under control by communication protocol.

T<sub>1</sub>(Typ.): Maximum ambient temperature of full load.

T<sub>2</sub>(Typ.): T<sub>1</sub>+5°C.

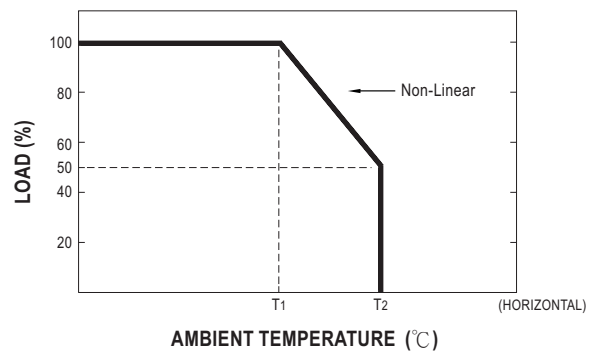
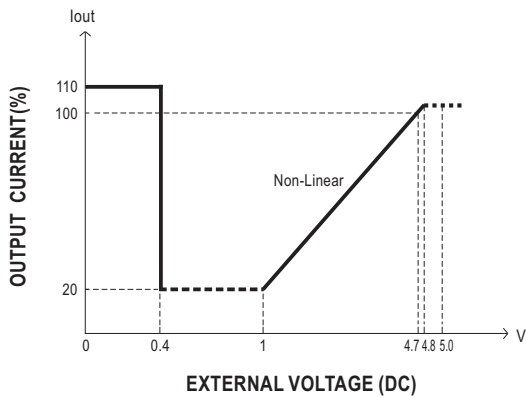

### 3. Remote ON-OFF Control

The power supply can be turned ON/OFF individually or along with other units in parallel by using the "Remote ON-OFF" function.

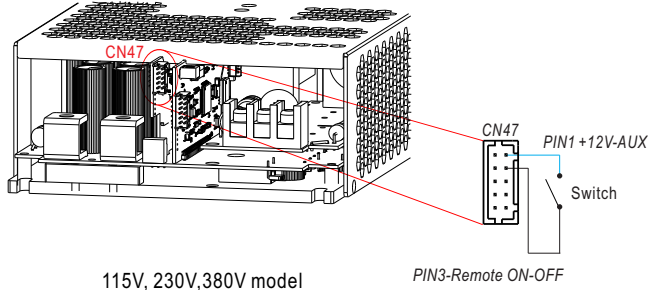

Remote ON-OFF	Power Supply Status
Short circuit	ON
Open circuit	OFF

### 4. DC-OK Signal

DC-OK signal is a TTL level signal. The maximum sourcing current is 10mA and the maximum external voltage is 5.6V.

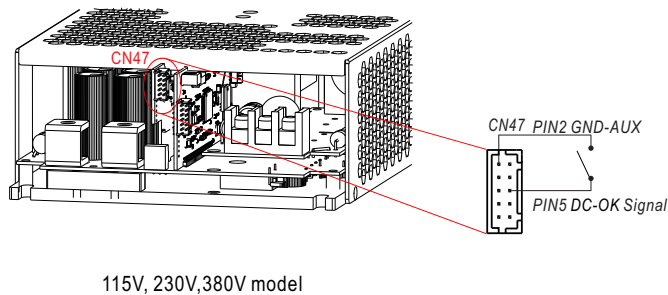

DC-OK signal	Power Supply Status
"High" >3.5~5.5V	OFF
"Low" <-0.5~0.5V	ON

### 5. PMBus Communication Interface

PHP-3500-HV supports PMBus Rev. 1.1 with maximum 100KHz bus speed, allowing information reading, status monitoring, output trimming, etc. For details, please refer to the Function Manual.

## MECHANICAL SPECIFICATION

Case No.278A Unit:mm

115V, 230V,380V model

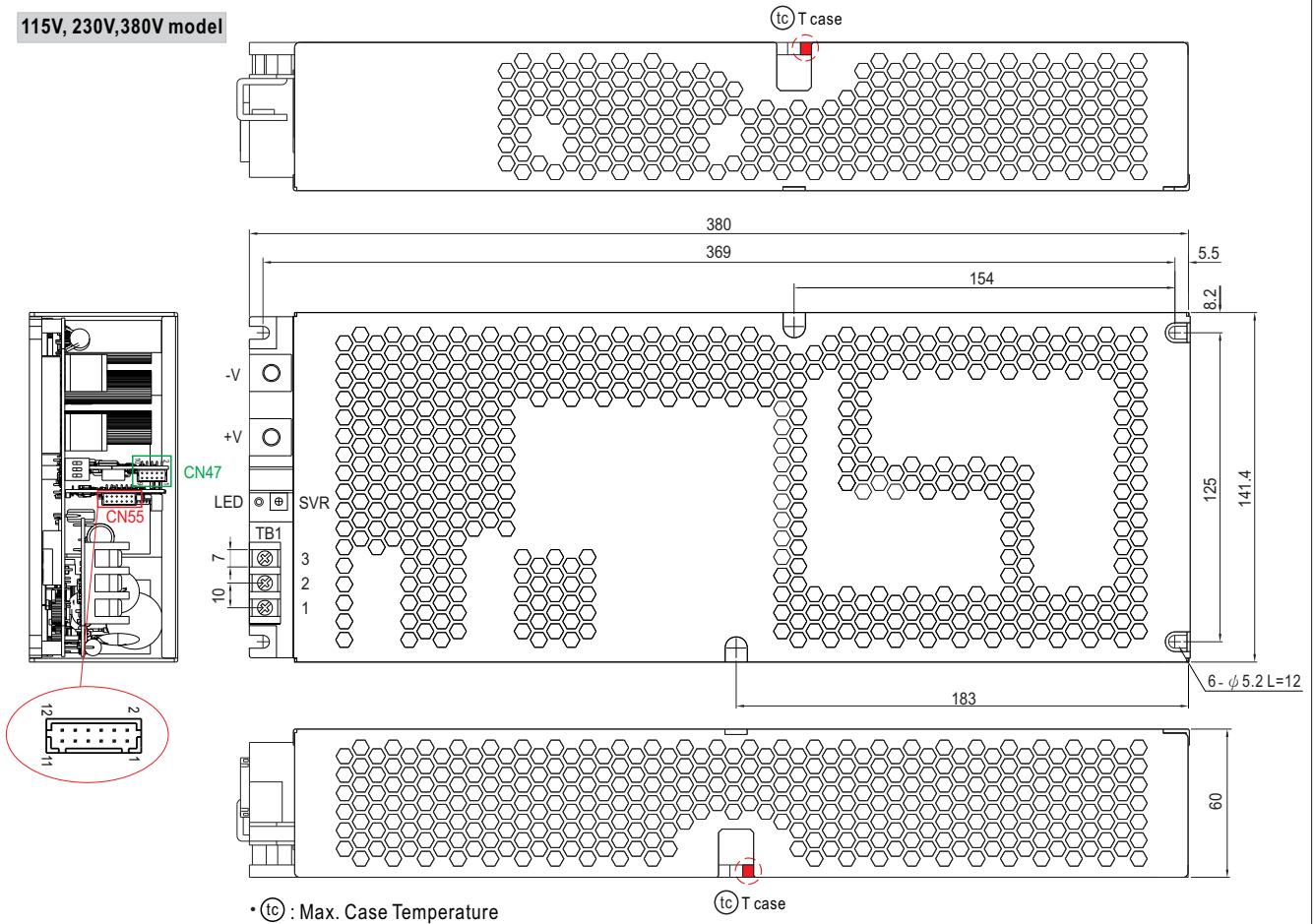

• (tc) : Max. Case Temperature

(tc) T case

### AC Input Terminal(TB1) Pin NO. Assignment

Pin No.	Assignment	Terminal	Max mounting torque
1	AC/L	DECA T25-EM10-03	18Kgf-cm
2	AC/N		
3	⊥		

### ※DC Output Terminal Pin No. Assignment

Assignment	Diagram	Maximum mounting torque
+V, -V		10Kgf-cm

### ※ LED Status Indicators

LED	Description
Green	The power supply functions normally.
Red(Flashing)	The LED will flash with red light when internal temperature reaches 85°C; under this condition, the unit still operates normally without entering OTP. (In the meantime, an alarm signal will be sent out through the PMBus / CANBus interface.)
Red	Abnormal status (Over temperature protection, Overload protection)

### ※Control Pin No. Assignment(CN55) : HRS DF11-12DP-2DS or equivalent

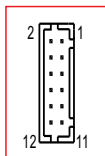

Mating Housing	HRS DF11-12DS or equivalent
Terminal	HRS DF11-12SC or equivalent

Pin No.	Function	Description
1,3	PV	Connection for output voltage programming. (Note.1)
2,4	PC	Connection for constant current level programming. (Note.1)
5,6	-V (Signal)	Negative output voltage signal.
7,8,9,10,11,12	NC	

Note1: Non-isolated signal, referenced to [-V(signal)].

※Control Pin No. Assignment(CN47) : HRS DF11-10DP-2DS or equivalent



Mating Housing	HRS DF11-10DS or equivalent
Terminal	HRS DF11-10SC or equivalent

Pin No.	Function	Description
1	+12V-AUX	Auxiliary voltage output, 10.8~13.2V, referenced to <i>GND-AUX</i> (pin 2). The maximum load current is 0.5A. This output has the built-in "Oring diodes" and is not controlled by the <i>Remote ON/OFF</i> control.
2	GND-AUX	Auxiliary voltage output GND. The signal return is isolated from the output terminals (+V & -V).
3	Remote ON-OFF	The unit can turn the output ON/OFF by electrical signal or dry contact between <i>Remote ON/OFF</i> and +12V-AUX. (Note.1) Short (10.8 ~ 13.2V) : Power ON ; Open (-0.5 ~ 0.5V) : Power OFF ; The maximum input voltage is 13.2V.
4	GND-AUX(S)	The signal return is isolated from the output terminals (+V & -V).
5	DC-OK	High (3.5 ~ 5.5V) : When the $V_{out} \leq 80\% \pm 5\%$ . Low (-0.5 ~ 0.5V) : When $V_{out} \geq 80\% \pm 5\%$ . The maximum sourcing current is 10mA and only for output. (Note.1)
6	T-ALARM	High (3.5 ~ 5.5V) : When the internal temperature exceeds the limit of temperature alarm. Low (-0.5 ~ 0.5V) : When the internal temperature is normal. The maximum sourcing current is 10mA and only for output(Note.1)
7,8	SDA	For PMBus model: Serial Data used in the PMBus interface. (Note.1)
	CANH	For CANBus model: Data line used in CANBus interface. (Note.1)
9,10	SCL	For PMBus model: Serial Clock used in the PMBus interface. (Note.1)
	CANL	For CANBus model: Data line used in CANBus interface. (Note.1)

Note1: Isolated signal, referenced to GND-AUX(S).



## GUIDANCE OF ADDITIONAL FILTER

### 1.Schematic

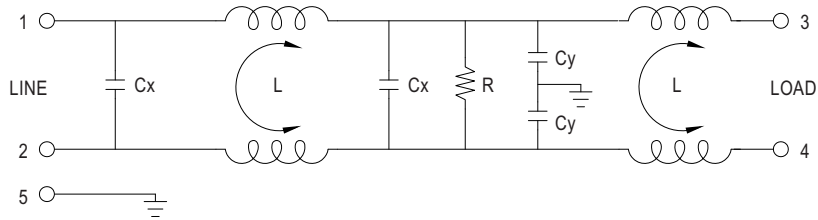

### 2.Minimum insertion loss (In dB at 50 Ω system)

FREQ. MHz	0.01	0.05	0.10	0.15	0.50	1.0	5.0	10	30
COM. MODE dB	2	5	8	10	30	35	55	45	30
DIF. MODE dB	4	15	18	18	45	50	40	40	40

### 3.Configuration

