

Model No.: **CR2025**

Description : Flat Lithium Battery
Chemical system : Lithium Manganese Dioxide
Nominal voltage : 3 Volts
Nominal capacity : 160mAh
Dimensions : $\varnothing 20.0 \times 2.5$ mm
Shelf life : 5 years at room temperature
Average weight : 2.4 grams
Application : Computer memory back up, Photo

Cross References:

IEC	JIS	Eveready	Varta	Duracell
CR2025	CR2025	ECR2025	CR2025	DL2025

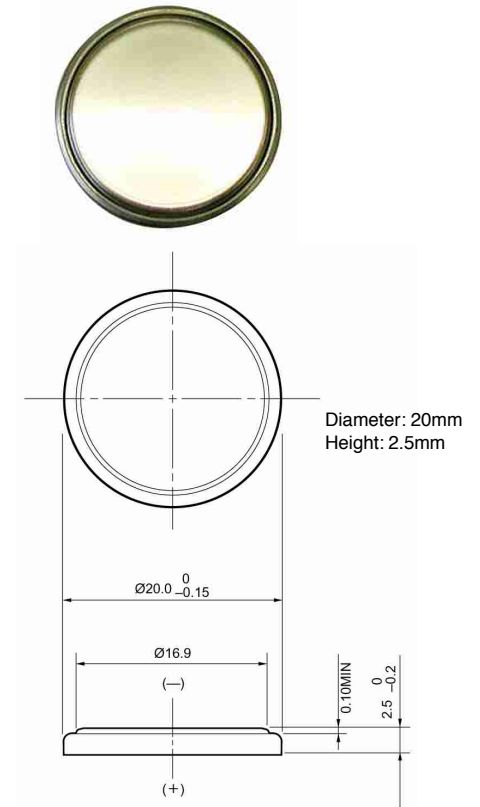

Dimension Drawing

Discharge Characteristics on Load

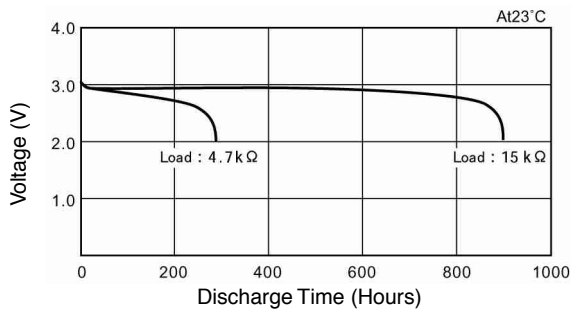

Discharge Characteristics on Temperature

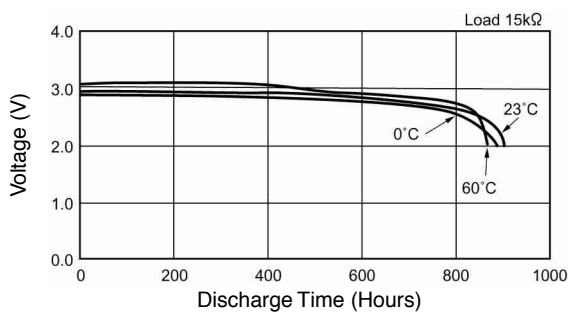

Discharge Load vs. Discharge Capacity

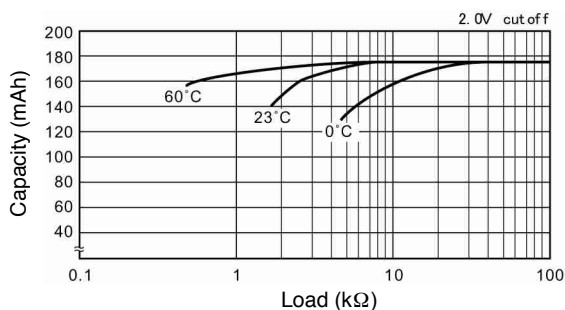

Discharge Characteristics on Pulse Load (Discharge depth 40%)

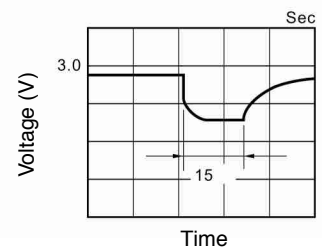
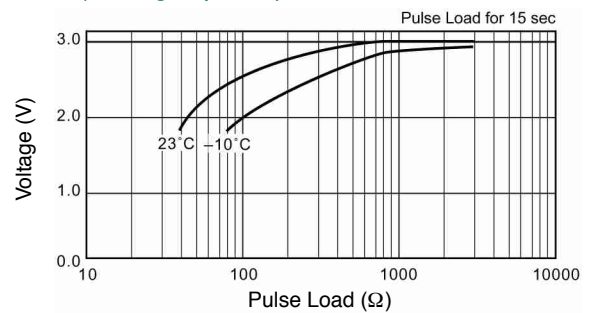

The information (subject to change without prior notice) contained in this document is for reference only and should not be used as a basis for product guarantee or warranty. For applications other than those described here, please consult your nearest GP Sales and Marketing Office or Distributors.