

"Schutzvermerk nach DIN ISO 16016 beachten" "Please pay attention to copyright note DIN ISO 16016"

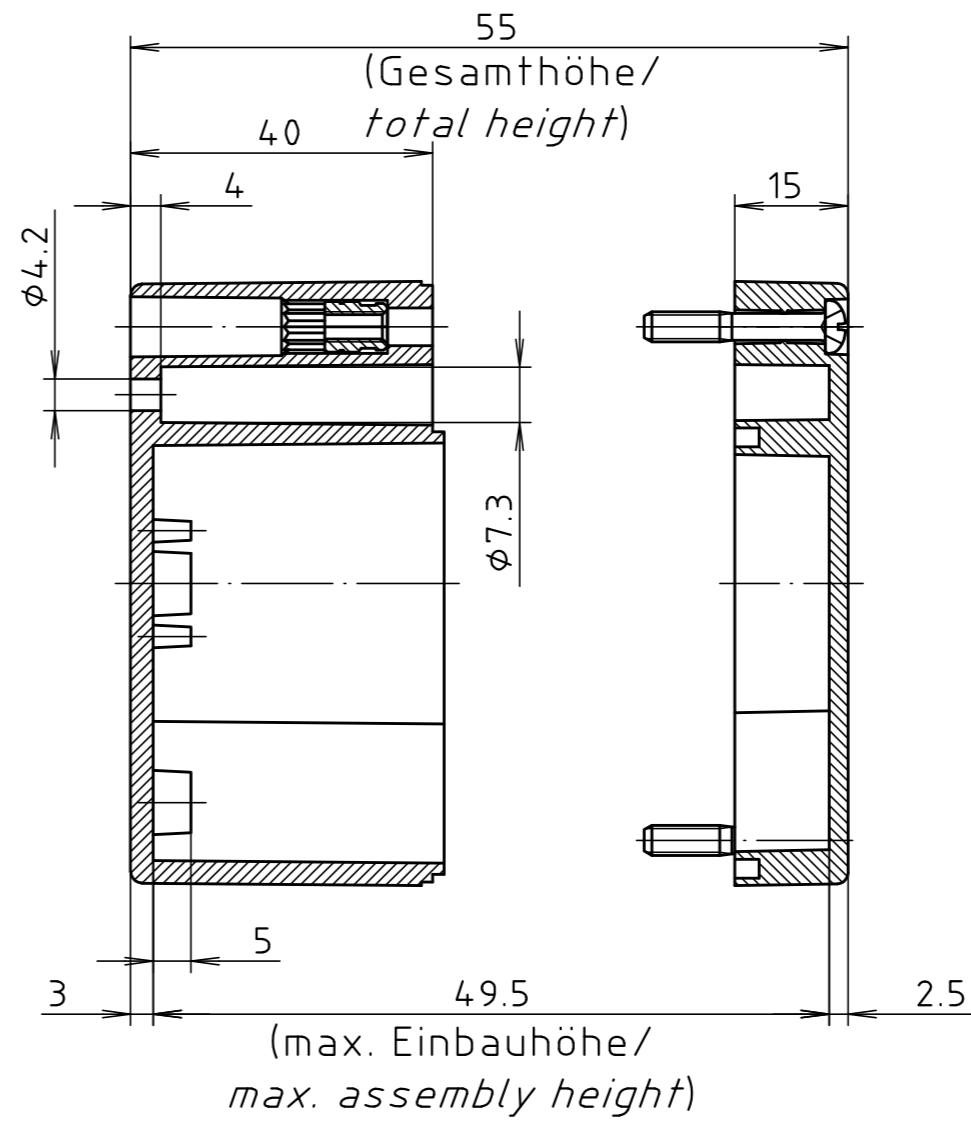
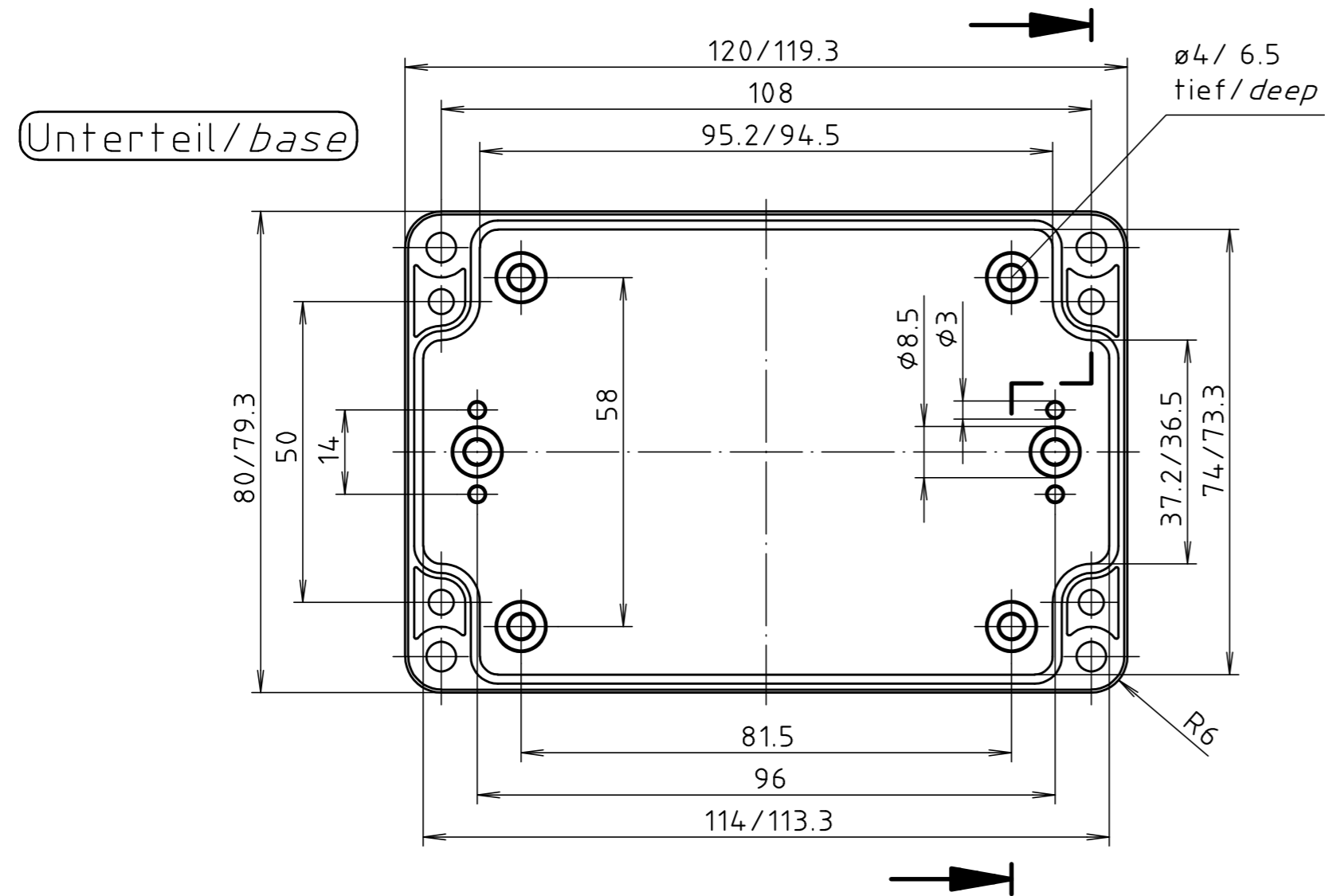
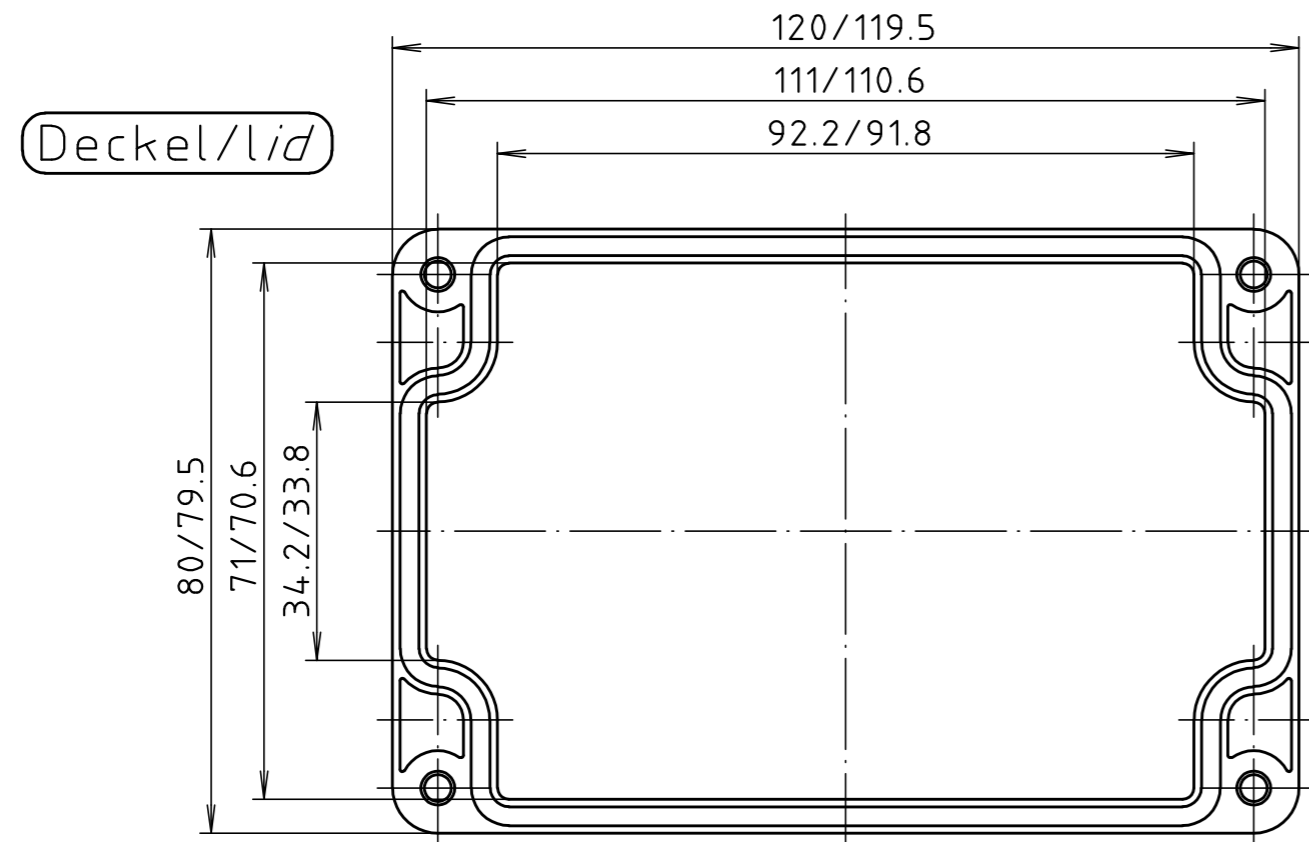

		Allgemein- toleranzen DIN		Maßstab 1:1	Gewicht
				Werkstoff ABS	Rohteil-Nr.
		Datum	Name	Benennung	
		Bearb. 28.01.20	ES	ABS 310500 5U Gehäuse/ Enclosure	
		Gepr.		Zchn.-Nr.	Blatt
		Norm		5U310500	Bl.
Zust.	Anderung	Datum	Name	Urspr.	Ers.für
					Ers.durch