



DDRH-15-xxP



DDRH-15-xxST



DDRH-15-xxDR



TPTC004



## ■ Features

- 150~1500Vdc 10:1 ultra-wide input range
- 4KVac I/O high isolation(Reinforced isolation)
- Protections: Short circuit / Overload / Over voltage / DC input under voltage / DC input reverse Polarity
- Fanless design, fully encapsulated, cooling by free air convection
- Can be installed on DIN rail TS-35/7.5 or 15 (DR-Type)
- -40~+80°C ultra-wide operating temperature (> +50°C derating)
- Operating altitude up to 5000 meters
- 3 years warranty

## ■ Applications

- Photovoltaic power generation
- Renewable Energy System
- High voltage frequency conversion
- Industrial control system
- Semiconductor fabrication equipment
- Electro-mechanical apparatus
- DC bus centralized application
- Energy storage system(ESS)
- Charging pile
- Third rail

## ■ GTIN CODE

MW Search: <https://www.meanwell.com/serviceGTIN.aspx>

## ■ Description

DDRH-15 series is a 150 ~ 1500Vdc high reliable ultra-high input DC-DC converter which can supply stable working voltage for the load. Main features are as following: compact size, -40~+80°C wide range operating temperature, 4KVac high isolation voltage, operation at 5000m altitude, low ripple & noise, complete protections and so on. Furthermore, this series also has DIN Rail type, it is suitable to be mounted on TS-35/7.5 or TS-35/15 rails. DDRH-15 is designed to meet UL1741(By requested) and IEC62109-1 standard. It is suitable for industrial automation, surveillance, telecommunication and can be widely deployed in the applications of new energy generation such as solar power, and windmill power generation, for instances, photovoltaic power systems, high voltage inverting , DC bus centralized application, ESS, charging pile, railway and so forth.

## ■ Model Encoding

DDRH - 15 - 12 P

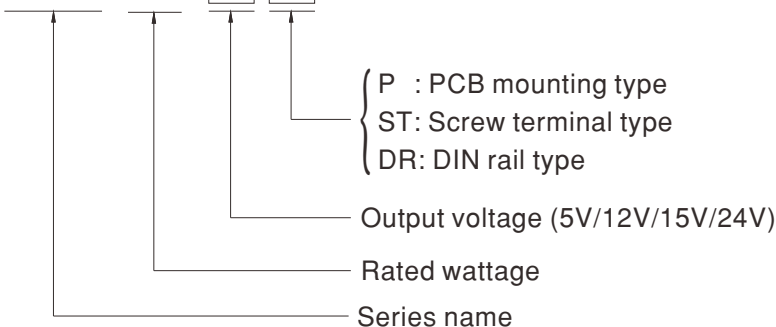



MODEL SELECTION TABLE							
ORDER NO.	INPUT			OUTPUT		EFFICIENCY (Typ.)	CAPACITOR LOAD (MAX.)
	INPUT VOLTAGE (RANGE)	INPUT CURRENT		OUTPUT VOLTAGE	OUTPUT CURRENT		
		NO LOAD	FULL LOAD				
DDRH-15-05 <input type="checkbox"/>	Nominal 800Vdc (150~1500Vdc)	0.2mA	25mA	5V	2A	78%	2000 $\mu$ F
DDRH-15-12 <input type="checkbox"/>		0.2mA	30mA	12V	1.25A	79%	1250 $\mu$ F
DDRH-15-15 <input type="checkbox"/>		0.2mA	30mA	15V	1A	87%	1000 $\mu$ F
DDRH-15-24 <input type="checkbox"/>		0.2mA	30mA	24V	0.625A	88%	625 $\mu$ F

 = P, ST, DR



SPECIFICATION				
INPUT	VOLTAGE RANGE		150 ~ 1500Vdc	
	FILTER		Pi type	
	EXTERNAL INPUT FUSE		4A/1500Vdc, required (Please refer to page 6 for more details)	
	INRUSH CURRENT (Typ.)		Cold start 150A max. @ Vin=800Vdc	
OUTPUT	VOLTAGE ACCURACY		±2.0%	
	RATED POWER		5Vo: 10W    12Vo ~ 24Vo: 15W	
	RIPPLE & NOISE Note.2		5 ~ 15Vo: 100mVp-p    24Vo: 150mVp-p	
	LINE REGULATION		±1%	
	LOAD REGULATION		±1% (10% Load to Full Load)	
	SWITCHING FREQUENCY (Typ.)		25 ~ 75.6KHz	
	HOLD UP TIME		16ms min. @Vin=800Vdc	
	SETUP TIME		1s max. @150~1500Vdc	
PROTECTION	SHORT CIRCUIT			
	Protection type : Hiccup mode, continuous, automatic recovery			
	OVERLOAD			
	110 ~ 300% rated output power			
	Protection type : Hiccup mode, recovers automatically after fault condition is removed			
OVER VOLTAGE				
Hiccup mode, recovers automatically after fault condition is removed				
DC INPUT	REVERSE POLARITY			
	By internal Bridge Diode, no damage, recovers automatically after fault condition removed			
LOCKOUT	UNDER VOLTAGE		Start-up voltage    147Vdc	
	SHUTDOWN VOLTAGE		Shutdown voltage    137Vdc	
ENVIRONMENT	WORKING TEMP. Note.3		-40 ~ +80°C (Refer to "Derating Curve")	
	WORKING HUMIDITY		20% ~ 90% RH non-condensing	
	STORAGE TEMP., HUMIDITY		-40 ~ +85°C, 10 ~ 95% RH non-condensing	
	TEMP. COEFFICIENT		±0.02% / °C (0 ~ 50°C)	
	VIBRATION		Component: 10 ~ 500Hz, 3G 10min./1cycle, 60min. each along X, Y, Z axes; Mounting clip: Compliance to IEC60068-2-6	
	OPERATING ALTITUDE Note.4		5000 meters	
	OVER VOLTAGE CATEGORY		II ; According to EN62109-1; altitude up to 5000 meters	
SAFETY & EMC (Note.5)	SAFETY STANDARDS			
	IEC62109-1(LVD), EAC TP TC 004 approved; Design refer to UL1741(By requested)			
	WITHSTAND VOLTAGE			
	I/P-O/P:4KVac			
	ISOLATION RESISTANCE			
	I/P-O/P, 100M Ohms / 500VDC / 25°C / 70% RH			
	EMC EMISSION	Parameter		Standard
		Conducted		BS EN/EN55032
	Radiated		BS EN/EN55032	Class A (with external components)
	EMC IMMUNITY	BS EN/EN55035		
Parameter		Standard		
ESD		BS EN/EN61000-4-2	Level 3, 8KV air; Level 2, 4KV contact, criteria A	
Radiated Susceptibility		BS EN/EN61000-4-3	Level 3, 10V, criteria A	
EFT/Burest		BS EN/EN61000-4-4	Level 2, 0.5KV, criteria A	
Surge		BS EN/EN61000-4-5	Level 4, 2KV/Vin+ ~ Vin-, criteria A	
Conducted		BS EN/EN61000-4-6	Level 3, 10V, criteria A	
OTHERS	MTBF			
	388Khrs MIL-HDBK-217F(25°C)			
	DIMENSION (L*W*H)			
	P Type: 76.2*50.8*25mm, ST Type: 122.3*57.3*32mm, DR Type: 122.3*57.3*43.5mm			
	CASE MATERIAL			
	Non-conductive black plastic (UL 94V-0 rated)			
POTTING MATERIAL				
UL 94V-0				
PIN MATERIAL				
Base: copper, Plating: Matte Tin				
PACKING				
P Type : 170g ; 6pcs/Tray, 18pcs/per carton ST Type : 210g ; 6pcs/Tray, 18pcs/per carton DR Type : 215g ; 6pcs/Tray, 18pcs/per carton				
NOTE	<p>1. All parameters NOT specially mentioned are measured at 800Vdc input, rated load and 25°C of ambient temperature.</p> <p>2. Ripple &amp; noise are measured at 20MHz of bandwidth by using a 12" twisted pair-wire terminated with a 0.1µf &amp; 47µf parallel capacitor.</p> <p>3. Derating may be needed under low input voltage. Please check the derating curve for more details.</p> <p>4. The ambient temperature derating of 3.5°C/1000m with fanless models and of 5°C/1000m with fan models for operating altitude higher than 2000m(6500ft).</p> <p>5. The power supply is considered a component which will be installed into a final equipment. The final equipment must be re-confirmed that it still meets EMC directives. For guidance on how to perform these EMC tests, please refer to "EMI testing of component power supplies." (as available on <a href="http://www.meanwell.com">http://www.meanwell.com</a>)</p> <p>※ Product Liability Disclaimer : For detailed information, please refer to <a href="https://www.meanwell.com/serviceDisclaimer.aspx">https://www.meanwell.com/serviceDisclaimer.aspx</a></p>			

### Derating Curve

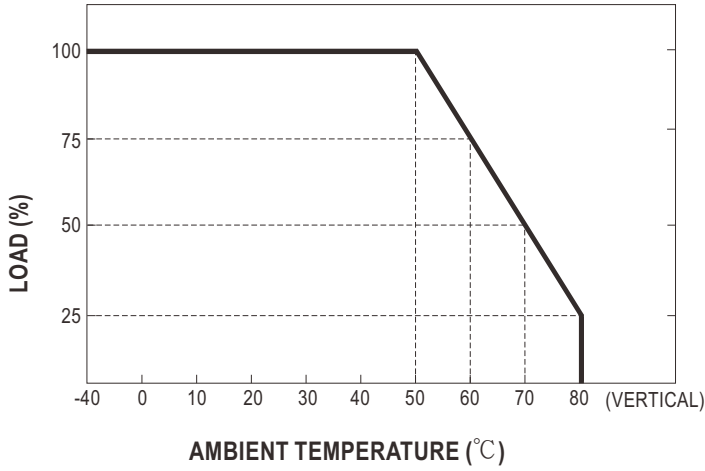

### Mechanical Specification

- All dimensions in mm(inch)
- Tolerance:  $x.xx \pm 0.03\text{mm}$  ( $x.x \pm 0.01"$ )  
 $x.xxx \pm 0.02\text{mm}$  ( $x.xx \pm 0.00078"$ )
- Pin size is:  $x.x \pm 0.7\text{mm}$  ( $x.x \pm 0.0275"$ )  
 $x.xx \pm 0.5\text{mm}$  ( $x.x \pm 0.0196"$ )

### DDRH-15-xxP (PCB Mounting Type)

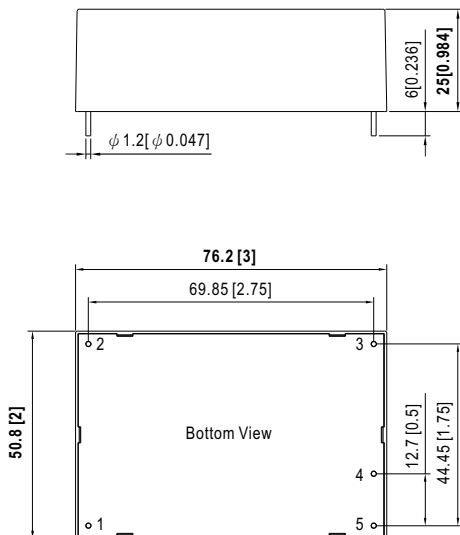

### Plug Assignment

Pin-Out	
Pin No.	Output
1	-Vin
2	+Vin
3	NC
4	-Vout
5	+Vout

### DDRH-15-xxST (Screw Terminal Type)

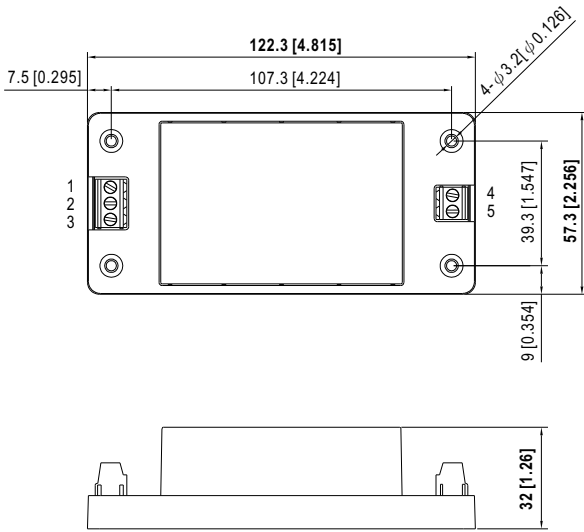

#### Terminal Pin No. Assignment

Pin-Out		
Pin No.	Output	Mating wire
1	-Vin	12~24AWG
2	NC	
3	+Vin	
4	+Vout	
5	-Vout	

Note: Recommended torque setting for terminal is 5kgf-cm(4.4 Lb-in)

### DDRH-15-xxDR (DIN Rail Type)

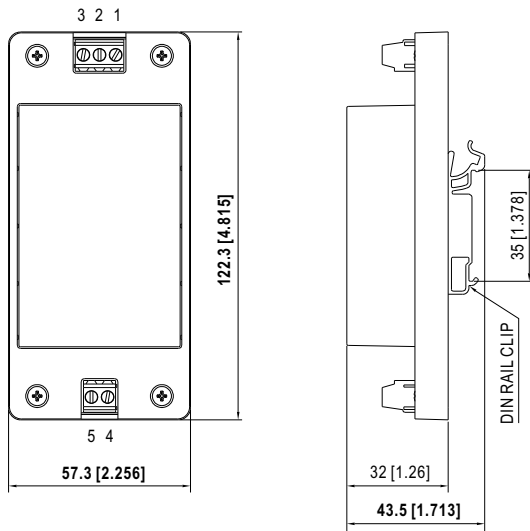

#### Terminal Pin No. Assignment

Pin-Out		
Pin No.	Output	Mating wire
1	-Vin	12~24AWG
2	NC	
3	+Vin	
4	+Vout	
5	-Vout	

Note: Recommended torque setting for terminal is 5kgf-cm(4.4 Lb-in)

#### Installation Instruction(DDRH-15-xxDR only)

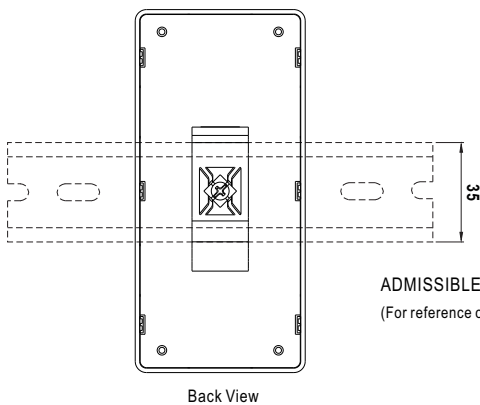

ADMISSIBLE DIN-RAIL: TS35/7.5 or TS35/15  
(For reference only. Not included with unit.)

Back View

### EMC Suggestion Circuit

※EMI test standard: BS EN/EN55032 Class A conducted and radiated emission are as below:

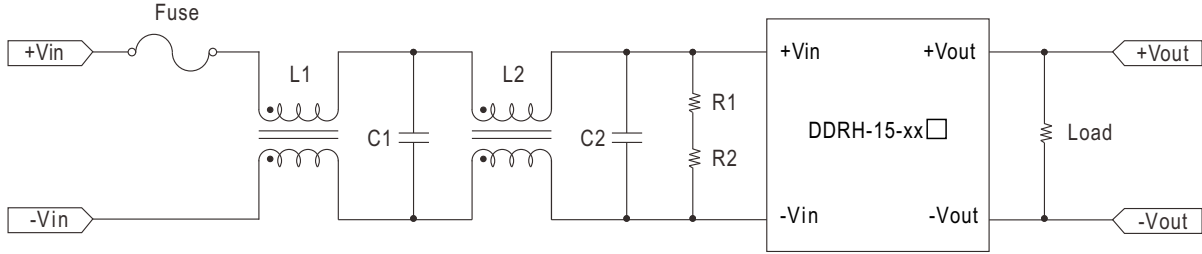

Model No.	BS EN/EN55032 Class A			
	Fuse	L1,L2	C1,C2	R1,R2
DDRH-15-xxP	4A/1500Vdc	Common choke 25mH SQ1212	0.33μF/1500Vdc	1/2W 3M, ≥ 800V
DDRH-15-xxST				
DDRH-15-xxDR				

### External Fuse Wiring Instruction

External FUSE is required. FUSE specification: 4A/1500Vdc.

Suggested model:

Fuse Brand	Manufacturer Part NO.		MW's Order NO.
	Fuse	Fuse Holder	Fuse + Fuse Holder
WalterFuse	WJ30-4	WJ30-H	<a href="#">WJ30-4_WJ30-H</a>

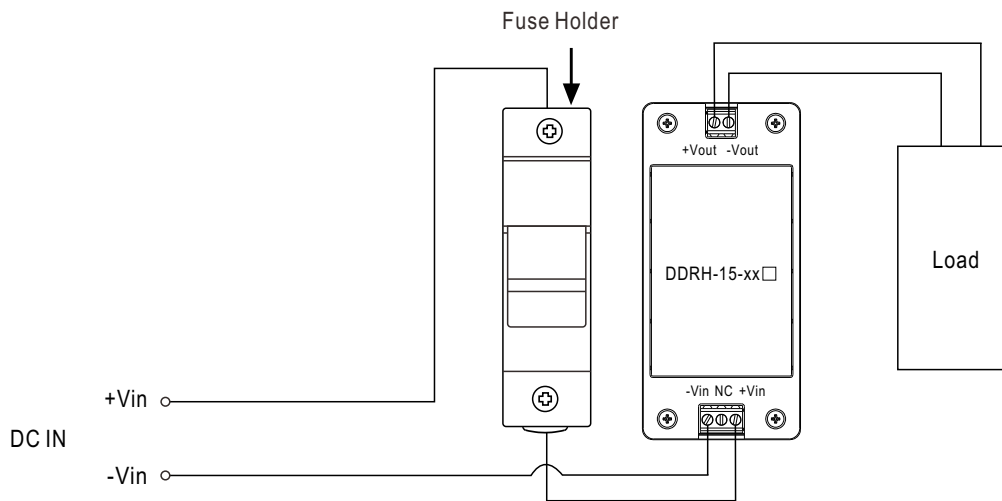

**Packing**

Standard Packing	DDRH-15-xxP			
	MPQ Per Tray(PCS)	One Tray G.W.	Max. Q'TY/ Carton(PCS)	One Carton G.W.
<p>Unit : mm</p> <p>DDRH-15-xxP</p> <p>Antistatic Plastic blister</p> <p>Antistatic Plastic blister</p> <p>Antistatic Foam</p> <p>CARTON L400x W320 x H225</p>	6	1.2Kg	18	4.6Kg

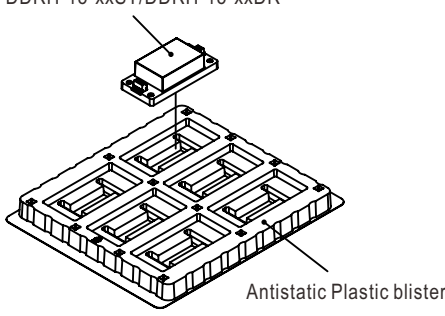
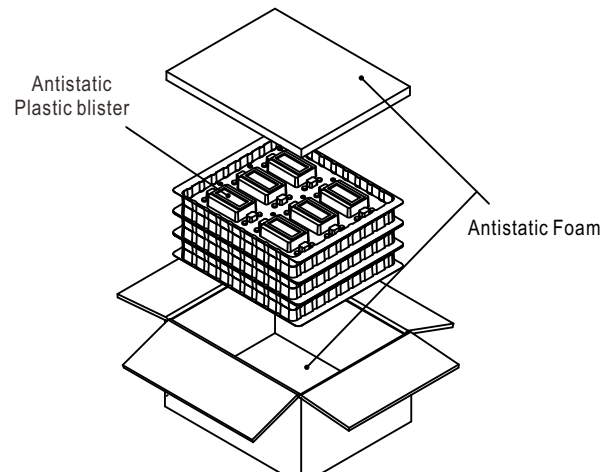
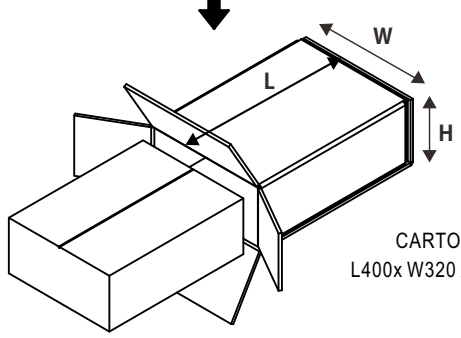
Standard Packing	DDRH-15-xxST			
	MPQ Per Tray(PCS)	One Tray G.W.	Max. Q'TY/ Carton(PCS)	One Carton G.W.
<p>Unit : mm</p> <p>DDRH-15-xxST/DDRH-15-xxDR</p>  <p>Antistatic Plastic blister</p> <p>↓</p>  <p>Antistatic Plastic blister</p> <p>Antistatic Foam</p> <p>↓</p>  <p>CARTON L400x W320 x H225</p>	6	1.43Kg	18	5.3Kg
	DDRH-15-xxDR			
	MPQ Per Tray(PCS)	One Tray G.W.	Max. Q'TY/ Carton(PCS)	One Carton G.W.
	6	1.46Kg	18	5.4Kg

■ Installation Manual

Please refer to : <http://www.meanwell.com/manual.html>