



3200~12800W 1U Distributed Power/Charger System **DHP-1UT-B Rack System**

Rack Dimension

L	*	W	*	H	
400	*	440	*	44 (1U)	mm
14.4	*	17.3	*	1.73(1U)	inch



Front



Back



■ Features

- Universal AC input / Full range
- 1U profile 19" rack shelf, fitting four 3200W modules up to 12800W with active current sharing
- Maximum 10 rack shelves in parallel
- Output voltage and current programmable
- Support hot swap (hot plug)
- Built-in PMBus/CANBus protocol
- 5 years warranty

■ Applications

- Industrial automation
- Distributed power architecture system
- Wireless/telecommunication solution
- Redundant power system
- Large scale DC UPS or emergency backup system
- Electric scooter or vehicle charger station
- Wastewater treatment system
- Electrolysis system

■ GTIN CODE

MW Search: <https://www.meanwell.com/serviceGTIN.aspx>

■ Description

DHP-1UT-B rack power system and rack charger system are the complete solution for the power distribution utilizing the rack configuration with the 1U low profile. Starting with a single unit of 3200W, NCP-3200 is a 2-in-1 Rack-mounted Switching Power Supply & Battery Charger. NCP-3200-380 is the power supply and 380V output voltage. With the active current sharing function, up to 12800W is able to be provided by 1 stack of the 19" rack mountable shelf DHP-1UT-B(HV), with either rectifier or charger, and maximum 19" rack mountable shelf that can be connected in parallel is ten.

■ Model Encoding

DHP-1U T -B

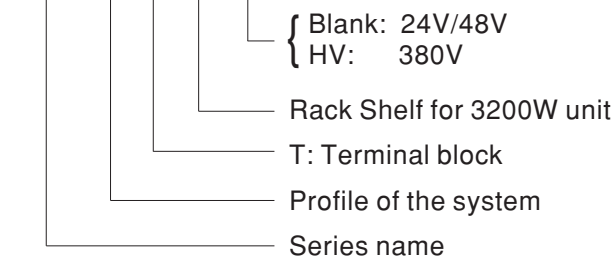



3200~12800W 1U Distributed Power/Charger System **DHP-1UT-B Rack System**

SPECIFICATION FOR POWER SUPPLY SYSTEM (Default)

POWER SYSTEM CONFIGURATION	19" RACK SHELF	DHP-1UT-B		
	POWER UNIT	NCP-3200-24*4	NCP-3200-48*4	
OUTPUT	OUTPUT VOLTAGE	24V	48V	
	MAX. OUTPUT CURRENT	532A	268A	
	MAX. OUTPUT POWER <small>Note.4</small>	12768W	12864W	
INPUT	VOLTAGE RANGE <small>Note.6</small>	90 ~ 264VAC 127 ~ 400VDC		
	FREQUENCY RANGE	47 ~ 63Hz		
	AC CURRENT (Typ.) per RECTIFIER	17A/230VAC		
	LEAKAGE CURRENT per RECTIFIER <small>Note.8</small>	<2mA / 230VAC		
FUNCTION	OUTPUT VOLTAGE PROGRAMMABLE(PV)	Adjustment of output voltage is allowable to 50 ~ 125% of nominal output voltage. Please refer to the Function Manual in following pages		
	CONSTANT CURRENT LEVEL PROGRAMMABLE(PC)	Adjustment of constant current level is allowable to 20 ~ 100% of rated current. Please refer to the Function Manual in following pages		
	REMOTE ON-OFF CONTROL	By electrical signal or dry contact ON:short OFF:open. Please refer to the Function Manual in following pages		
	REMOTE SENSE	Compensate voltage drop on the load wiring up to 0.5V		
	AUXILIARY POWER	5V @ 0.3A, tolerance ± 10%, ripple 150mVp-p, 12V @ 0.8A, tolerance ± 10%, ripple 450mVp-p		
	ALARM SIGNAL	Isolated TTL signal output for T-Alarm, AC-OK and DC-OK		
ENVIRONMENT	WORKING TEMP.	-30 ~ +70°C, when 3 or 4 power units are paralleled in power shelf, highest working temperature shall de-rate to 40°C at full load		
	WORKING HUMIDITY	20 ~ 90% RH non-condensing		
	STORAGE TEMP., HUMIDITY	-40 ~ +85°C, 10 ~ 95% RH non-condensing		
	TEMP. COEFFICIENT	±0.03%/°C (0 ~ 50°C)		
	VIBRATION	10 ~ 500Hz, 2G 10min./1cycle, 60min. each along X, Y, Z axes		
SAFETY & EMC (Note 9)	SAFETY STANDARDS	UL62368-1, CSA C22.2 No. 62368-1, TUV BS EN/EN62368-1, EAC TP TC 004 approved ; Design refer to AS/NZS62368.1		
	WITHSTAND VOLTAGE	I/P-O/P:3KVAC I/P-FG:2KVAC O/P-FG:1.5KVDC		
	ISOLATION RESISTANCE	I/P-O/P, I/P-FG, O/P-FG:100M Ohms / 500VDC / 25°C / 70% RH		
	EMC EMISSION	Parameter	Standard	Test Level / Note
		Conducted	BS EN/EN55032 (CISPR32)	Class B
		Radiated	BS EN/EN55032 (CISPR32)	Class A
		Harmonic Current	BS EN/EN61000-3-2	Class A
		Voltage Flicker	BS EN/EN61000-3-3	-----
	EMC IMMUNITY	BS EN/EN55024, BS EN/EN61000-6-2		
		Parameter	Standard	Test Level / Note
		ESD	BS EN/EN61000-4-2	Level 3, 8KV air ; Level 2, 4KV contact
		Radiated	BS EN/EN61000-4-3	Level 3
EFT / Burst		BS EN/EN61000-4-4	Level 3	
Surge		BS EN/EN61000-4-5	Level 4, 2KV/Line-Line 4KV/Line-Earth	
Conducted		BS EN/EN61000-4-6	Level 3	
Magnetic Field		BS EN/EN61000-4-8	Level 4	
Voltage Dips and Interruptions	BS EN/EN61000-4-11	>95% dip 0.5 periods, 30% dip 25 periods, >95% interruptions 250 periods		
OTHERS	MTBF	3698.9K hrs min. Telcordia SR-332 (Bellcore) ; 818.3K hrs min. MIL-HDBK-217F (25°C)		
	DIMENSION	Rack 400*482.6*44(L*W*H, with mounting bracket) ; 400*440*44(L*W*H, without mounting bracket)		
	PACKING	4.76Kg; 3pcs/17.4Kg/3.3UFT		
NOTE	<p>1. All parameters NOT specially mentioned are measured at 230VAC input, rated load and 25°C of ambient temperature.</p> <p>2. Ripple & noise are measured at 20MHz of bandwidth by using a 12" twisted pair-wire terminated with a 0.1uf & 47uf parallel capacitor. Under parallel operation of more than one rack connecting together, ripple of the output voltage may be higher than the SPEC at light load condition. It will go back to normal ripple level once the output load is more than 5%.</p> <p>3. Tolerance : includes set up tolerance, line regulation and load regulation.</p> <p>4. Output of all the NCP-3200 modules are connected in parallel in the rack.</p> <p>5. RCM is on a voluntary basis and meets relevant IEC or AS/NZS standards complying with AS/NES 4417.1.</p> <p>6. Derating may be needed under low input voltages. Please check the static characteristics for more details.</p> <p>7. Because of component tolerance, there is a possibility that some of units connected in parallel will reach an overcurrent limit then overloading the other units when operating at full load condition. If overload conditions happen in parallel usage, it is suggested that derate the total output current by 10%.</p> <p>8. The equivalent leakage current of the system is determined by the quantity of populated rectifiers.</p> <p>9. The power supply is considered a component which will be installed into a final equipment. All the EMC tests are been executed by mounting the unit on a 1000mm*1300mm metal plate with 2mm of thickness. The final equipment must be re-confirmed that it still meets EMC directives. For guidance on how to perform these EMC tests, please refer to "EMI testing of component power supplies." (as available on http://www.meanwell.com)</p> <p>10. The ambient temperature derating of 3.5°C/1000m with fanless models and of 5°C/1000m with fan models for operating altitude higher than 2000m(6500ft).</p> <p>※ Product Liability Disclaimer : For detailed information, please refer to https://www.meanwell.com/serviceDisclaimer.aspx</p>			



3200~12800W 1U Distributed Power/Charger System **DHP-1UT-B Rack System**

SPECIFICATION FOR POWER SUPPLY SYSTEM (Default)

POWER SYSTEM CONFIGURATION	19" RACK SHELF	DHP-1UT-BHV		
	POWER UNIT	NCP-3200-380*4		
OUTPUT	OUTPUT VOLTAGE (factory default)	380V		
	CURRENT (factory default)	33.6A		
	CURRENT RANGE	0 ~ 38.4A		
	MAX. OUTPUT POWER <small>Note.4</small>	12768W		
INPUT	VOLTAGE RANGE <small>Note.6</small>	90 ~ 264VAC	127 ~ 400VDC	
	FREQUENCY RANGE	47 ~ 63Hz		
	AC CURRENT (Typ.) per RECTIFIER	17A/230VAC		
	LEAKAGE CURRENT per RECTIFIER <small>Note.8</small>	<2mA / 230VAC		
FUNCTION	OUTPUT VOLTAGE PROGRAMMABLE(PV)	Adjustment of output voltage is allowable to 50 ~ 120% of nominal output voltage. Please refer to the Function Manual in following pages		
	CONSTANT CURRENT LEVEL PROGRAMMABLE(PC)	Adjustment of constant current level is allowable to 20 ~ 100% of rated current. Please refer to the Function Manual in following pages		
	REMOTE ON-OFF CONTROL	By electrical signal or dry contact ON:short OFF:open. Please refer to the Function Manual in following pages		
	AUXILIARY POWER	5V @ 0.3A, tolerance $\pm 10\%$, ripple 150mVp-p, 12V @ 0.8A, tolerance $\pm 10\%$, ripple 450mVp-p		
	ALARM SIGNAL	Isolated TTL signal output for T-Alarm, AC-OK and DC-OK		
ENVIRONMENT	WORKING TEMP.	-30 ~ +70°C, when 3 or 4 power units are paralleled in power shelf, highest working temperature shall de-rate to 40°C at full load		
	WORKING HUMIDITY	20 ~ 90% RH non-condensing		
	STORAGE TEMP., HUMIDITY	-40 ~ +85°C, 10 ~ 95% RH non-condensing		
	TEMP. COEFFICIENT	$\pm 0.03\%/^{\circ}\text{C}$ (0 ~ 50°C)		
	VIBRATION	10 ~ 500Hz, 2G 10min./1cycle, 60min. each along X, Y, Z axes		
SAFETY & EMC (Note 9)	SAFETY STANDARDS	UL62368-1, CSA C22.2 No. 62368-1, TUV BS EN/EN62368-1, EAC TP TC 004 approved ; Design refer to AS/NZS62368.1		
	WITHSTAND VOLTAGE	I/P-O/P:3KVAC I/P-FG:2KVAC O/P-FG:1.5KVDC		
	ISOLATION RESISTANCE	I/P-O/P, I/P-FG, O/P-FG:100M Ohms / 500VDC / 25°C / 70% RH		
	EMC EMISSION	Parameter	Standard	Test Level / Note
		Conducted	BS EN/EN55032 (CISPR32)	Class B
		Radiated	BS EN/EN55032 (CISPR32)	Class A
		Harmonic Current	BS EN/EN61000-3-2	Class A
		Voltage Flicker	BS EN/EN61000-3-3	-----
	EMC IMMUNITY	BS EN/EN55024, BS EN/EN61000-6-2		
		Parameter	Standard	Test Level / Note
		ESD	BS EN/EN61000-4-2	Level 3, 8KV air ; Level 2, 4KV contact
		Radiated	BS EN/EN61000-4-3	Level 3
		EFT / Burst	BS EN/EN61000-4-4	Level 3
Surge		BS EN/EN61000-4-5	Level 4, 2KV/Line-Line 4KV/Line-Earth	
Conducted		BS EN/EN61000-4-6	Level 3	
Magnetic Field		BS EN/EN61000-4-8	Level 4	
Voltage Dips and Interruptions	BS EN/EN61000-4-11	>95% dip 0.5 periods, 30% dip 25 periods, >95% interruptions 250 periods		
OTHERS	MTBF	3698.9K hrs min. Telcordia SR-332 (Bellcore) ; 818.3K hrs min. MIL-HDBK-217F (25°C)		
	DIMENSION	Rack 400*482.6*44(L*W*H, with mounting bracket) ; 400*440*44(L*W*H, without mounting bracket)		
	PACKING	4.76Kg; 3pcs/17.4Kg/3.3UFT		
NOTE	<ol style="list-style-type: none"> All parameters NOT specially mentioned are measured at 230VAC input, rated load and 25°C of ambient temperature. Ripple & noise are measured at 20MHz of bandwidth by using a 12" twisted pair-wire terminated with a 0.1uf & 47uf parallel capacitor. Under parallel operation of more than one rack connecting together, ripple of the output voltage may be higher than the SPEC at light load condition. It will go back to normal ripple level once the output load is more than 5%. Tolerance : includes set up tolerance, line regulation and load regulation. Output of all the NCP-3200 modules are connected in parallel in the rack. RCM is on a voluntary basis and meets relevant IEC or AS/NZS standards complying with AS/NES 4417.1. Derating may be needed under low input voltages. Please check the static characteristics for more details. Because of component tolerance, there is a possibility that some of units connected in parallel will reach an overcurrent limit then overloading the other units when operating at full load condition. If overload conditions happen in parallel usage, it is suggested that derate the total output current by 10%. The equivalent leakage current of the system is determined by the quantity of populated rectifiers. The power supply is considered a component which will be installed into a final equipment. All the EMC tests are been executed by mounting the unit on a 1000mm*1300mm metal plate with 2mm of thickness. The final equipment must be re-confirmed that it still meets EMC directives. For guidance on how to perform these EMC tests, please refer to "EMI testing of component power supplies." (as available on http://www.meanwell.com) The ambient temperature derating of 3.5°C/1000m with fanless models and of 5°C/1000m with fan models for operating altitude higher than 2000m(6500ft). <p>※ Product Liability Disclaimer : For detailed information, please refer to https://www.meanwell.com/serviceDisclaimer.aspx</p>			



3200~12800W 1U Distributed Power/Charger System **DHP-1UT-B Rack System**

SPECIFICATION FOR CHARGER SYSTEM (Selectable by PMBus, CANBus or SBP-001)

CHARGER SYSTEM CONFIGURATION	19" RACK SHELF	DHP-1UT-B		
	CHARGER UNIT	NCP-3200-24*4	NCP-3200-48*4	
OUTPUT	BOOST CHARGE VOLTAGE(Vboost)(default)	28.8V	57.6V	
	FLOAT CHARGE VOLTAGE(Vfloat)(default)	27.6V	55.2V	
	CURRENT RANGE	0 ~ 440A	0 ~ 220A	
INPUT	VOLTAGE RANGE <small>Note.2</small>	90 ~ 264VAC 127 ~ 400VDC		
	FREQUENCY RANGE	47 ~ 63Hz		
	AC CURRENT (Typ.) per CHARGER	17A/230VAC		
	LEAKAGE CURRENT per CHARGER <small>Note.4</small>	<2mA / 230VAC		
FUNCTION	REMOTE ON-OFF CONTROL	By electrical signal or dry contact ON:short OFF:open. Please refer to the Function Manual in following pages		
	AUXILIARY POWER	5V @ 0.3A, tolerance $\pm 10\%$, ripple 150mVp-p, 12V @ 0.8A, tolerance $\pm 10\%$, ripple 450mVp-p		
	ALARM SIGNAL	Isolated TTL signal output for T-Alarm, AC-OK and DC-OK. Please refer to Installation Manual		
ENVIRONMENT	WORKING TEMP.	-30 ~ +70°C when 3 or 4 charger units are paralleled in power shelf, highest working temperature shall de-rate to 40°C at full load		
	WORKING HUMIDITY	20 ~ 90% RH non-condensing		
	STORAGE TEMP., HUMIDITY	-40 ~ +85°C, 10 ~ 95% RH non-condensing		
	TEMP. COEFFICIENT	$\pm 0.03\%/^{\circ}\text{C}$ (0 ~ 50°C)		
	VIBRATION	10 ~ 500Hz, 2G 10min./1cycle, 60min. each along X, Y, Z axes		
SAFETY & EMC (Note 6)	SAFETY STANDARDS	UL62368-1, TUV BS EN/EN62368-1, EAC TP TC 004 approved		
	WITHSTAND VOLTAGE	I/P-O/P:3KVAC I/P-FG:2KVAC O/P-FG:1.5KVDC		
	ISOLATION RESISTANCE	I/P-O/P, I/P-FG, O/P-FG:100M Ohms / 500VDC / 25°C / 70% RH		
	EMC EMISSION	Parameter	Standard	Test Level / Note
		Conducted	BS EN/EN55032 (CISPR32)	Class B
		Radiated	BS EN/EN55032 (CISPR32)	Class A
		Harmonic Current	BS EN/EN61000-3-2	Class A
	Voltage Flicker	BS EN/EN61000-3-3	-----	
	EMC IMMUNITY	BS EN/EN55024, BS EN/EN61000-6-2		
		Parameter	Standard	Test Level / Note
ESD		BS EN/EN61000-4-2	Level 3, 8KV air ; Level 2, 4KV contact	
Radiated		BS EN/EN61000-4-3	Level 3	
EFT / Burst		BS EN/EN61000-4-4	Level 3	
Surge		BS EN/EN61000-4-5	Level 4, 2KV/Line-Line 4KV/Line-Earth	
Conducted		BS EN/EN61000-4-6	Level 3	
Magnetic Field		BS EN/EN61000-4-8	Level 4	
Voltage Dips and Interruptions	BS EN/EN61000-4-11	>95% dip 0.5 periods, 30% dip 25 periods, >95% interruptions 250 periods		
OTHERS	MTBF	3698.9K hrs min. Telcordia SR-332 (Bellcore) ; 818.3K hrs min. MIL-HDBK-217F (25°C)		
	DIMENSION	Rack 400*482.6*44(L*W*H, with mounting bracket) ; 400*440*44(L*W*H, without mounting bracket)		
	PACKING	4.76Kg; 3pcs/17.4Kg/3.3UFT		
NOTE	<p>1. All parameters NOT specially mentioned are measured at 230VAC input, rated load and 25°C of ambient temperature.</p> <p>2. Derating may be needed under low input voltages. Please check the static characteristics for more details.</p> <p>3. Output of all the NCP-3200 modules are connected in parallel in the rack.</p> <p>4. The equivalent leakage current of the system is determined by the quantity of populated chargers.</p> <p>5. RCM is on a voluntary basis and meets relevant IEC or AS/NZS standards complying with AS/NES 4417.1.</p> <p>6. The power supply is considered a component which will be installed into a final equipment. All the EMC tests are been executed by mounting the unit on a 1000mm*1300mm metal plate with 2mm of thickness. The final equipment must be re-confirmed that it still meets EMC directives. For guidance on how to perform these EMC tests, please refer to "EMI testing of component power supplies." (as available on http://www.meanwell.com)</p> <p>7. The ambient temperature derating of 3.5°C/1000m with fanless models and of 5°C/1000m with fan models for operating altitude higher than 2000m(6500ft).</p> <p>※ Product Liability Disclaimer : For detailed information, please refer to https://www.meanwell.com/serviceDisclaimer.aspx</p>			

FUNCTION MANUAL

1. Voltage Drop Compensation

- ※ Built-in remote sense circuit that is able to compensate voltage drop up to 0.5V.
- ※ When using this function, the sensing wires should either be twisted or shielded to prevent external noise interference (refer to Figure 1-1).
- ※ Voltage drop across the output wires must be limited to less than 0.5V. Also wires with adequate current rating should be used between +V, -V and the loads. Please firmly connect the output wires to prevent them from loosing, or the power supply may be out of order.
- ※ The +S and -S have to be connected to the +V(signal) and -V(signal), respectively, as shown in Figure 1-2, which is Local Sense, in order to get the correct output voltage if Remote Sense is not used. Otherwise, the output voltage will increase to a extremely high level which may trigger OVP.

1.1 Remote Sense (For 24V/48V models under power supply system only)

The remote sense compensates voltage drop on the load wiring up to 0.5V.

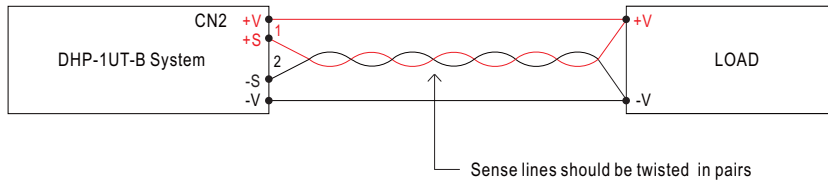

Figure 1-1 Connection of Remote Sense

1.2 Local Sense (For 24V/48V models under power supply system only)

Notice : The +S, -S have to be connected to the +V(signal), -V(signal), respectively, in order to get the correct output voltage if the remote sensing is not used.

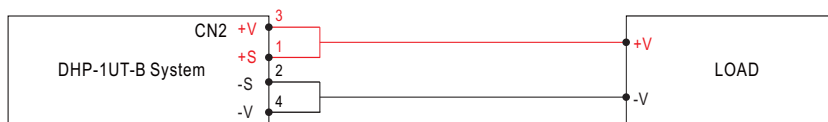
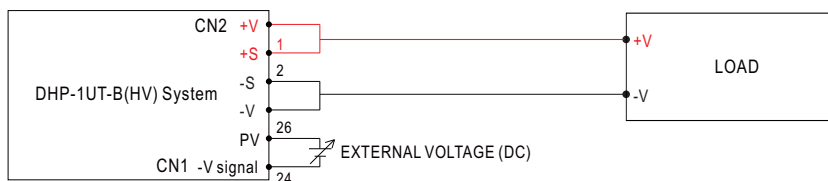

Figure 1-2 Connection of Local Sense

2. Output Voltage Programming (or, PV / remote voltage programming / remote adjust / margin programming / dynamic voltage trim)

- ※ In addition to the adjustment via the built-in potentiometer, the output voltage can be trimmed by applying EXTERNAL VOLTAGE.



+S & +V, -S & -V also need to be connected on CN2.

(Voltage compensation function for 24V/48V models under power supply system only)

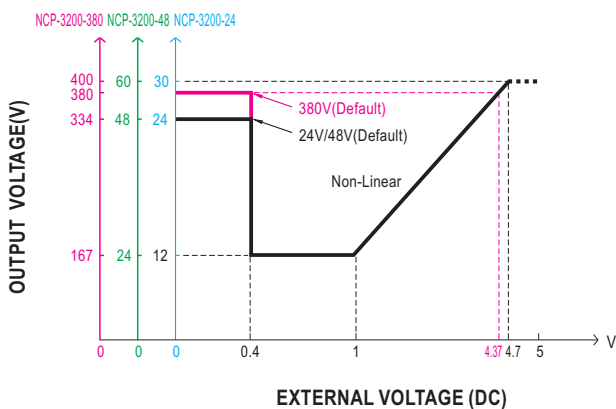

⊙ For power supply mode

⊙ The 100% output voltage is 24/48/334V.

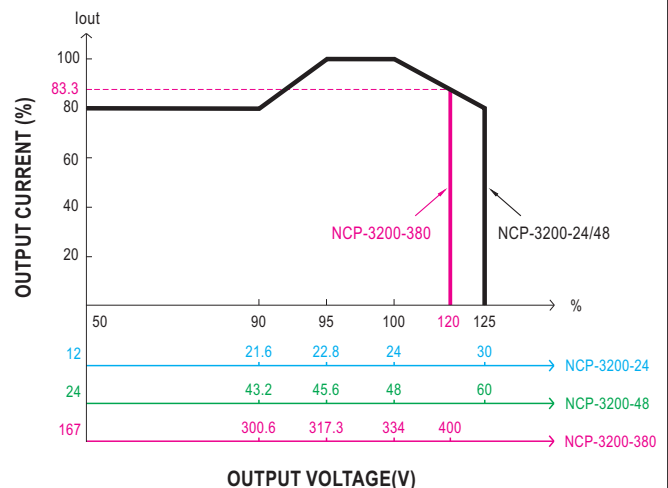

⊙ The rated current should change with the Output Voltage Programming accordingly.

⊙ The 100% output current is 532/268/38.4A.

⊙ For Remote Sense / Local Sense, please refer to "Voltage Drop Compensation" section.

3. Output Current Programming (or, PC / remote current programming / dynamic current trim)

※ The output current can be trimmed to 20~100% of the rated current by applying EXTERNAL VOLTAGE.

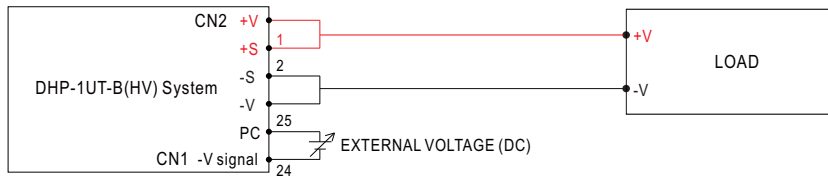

+S & +V, -S & -V also need to be connected on CN2. (For 24V/48V models under power supply system only)

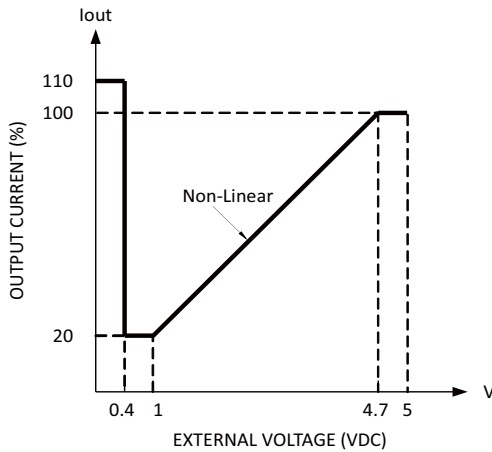

◎ For power supply system

◎ The 100% output current is 532/268/38.4A.

◎ Notice the output power do not over max. output power.

4. Remote Control

※ Built-in remote ON/OFF control circuit, refer to Figure 4-1 for control methods of single unit or whole rack system.

※ Please be aware that "ON/OFF" and "+5V-AUX" on CN1 should be linked together to allow the units operate normally; If kept open, there will be no output voltage.

※ Maximum input voltage 5.5V.

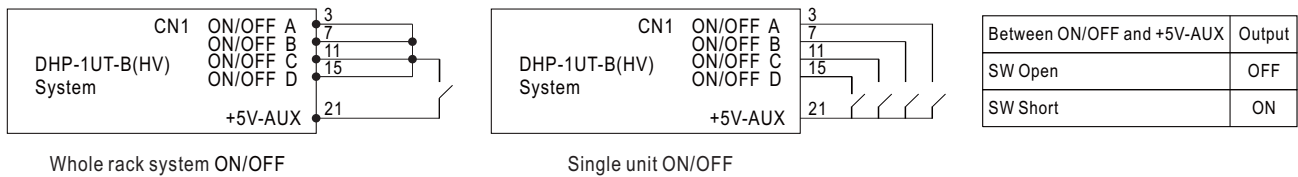

Figure 4-1 Connection of Remote Control

5. PMBus Communication Interface

NCP-3200 supports PMBus Rev. 1.1 with maximum 100KHz bus speed, allowing information reading, status monitoring, output trimming, etc. For details, please refer to the Function Manual.

6. CANBus Communication Interface

NCP-3200 supports CAN 2.0B with maximum 250KHz bus speed, allowing information reading, status monitoring, output trimming, etc. For details, please refer to the User's Manual.

7. Parallel Operation

7.1 Operation of Single Rack Shelf

※ Parallel operation in a single rack shelf is only suitable for the identical units (with the same model and the same output voltage/current).

※ Each rack shelf (DHP-1UT-B) has built-in parallel connection/wiring. Once have NCP-3200 units inserted in the rack shelf then these front end unit are operated in parallel.

※ Please refer to 1~4 for the connection/wiring of other functions.

※ Read installation manual before using this device. For NCP-3200-380 high output voltage model, correct rack system DHP-1UT-BHV should be used. Fail to do so will cause permanent damage.

19" Rack shelf	DHP-1UT-B	DHP-1UT-B	DHP-1UT-BHV
Power supply or battery charger unit	NCP-3200-24*4	NCP-3200-48*4	NCP-3200-380*4

7.2 Operation of two or more rack shelves in parallel

- ※ Parallel operation is only suitable for the identical units (with the same model and the same output voltage/current). Up to 10 rack shelves and the maximum supply units that can be connected in parallel is 40.
- ※ Because of component tolerance, there is a possibility that some of the units connected in parallel will reach an overcurrent limiting then overloading the other units when operating at full load condition. It is suggested that reduce the total output current by 10%.
For example: NCP-3200-24x8 connected in parallel (in 2 rack shelves), the total output current should be reduced to $133A \times 8unit \times 0.9 = 957.6A$.
- ※ Difference of output voltage among parallel units should be less than 0.2V.
- ※ Configure rack shelf units in parallel before connecting to the load. Do not connect rack shelf units to the load separately. Refer to Figure 7-1.
- ※ Control singles of DA, DB and -V should also be connected in parallel. (Refer to Figure 7-1).
- ※ Use twisted wires for the wiring of +S and -S, the twisted wires should not touch the load wires to avoid interference. Refer to Figure 7-1.
- ※ A too long cable length might be with a higher amount of noise that affects rack units' proper operation in parallel. To reduce the noise, installing termination resistors, an accessory, to the unused JK1 is recommended. Please refer to Accessory list.

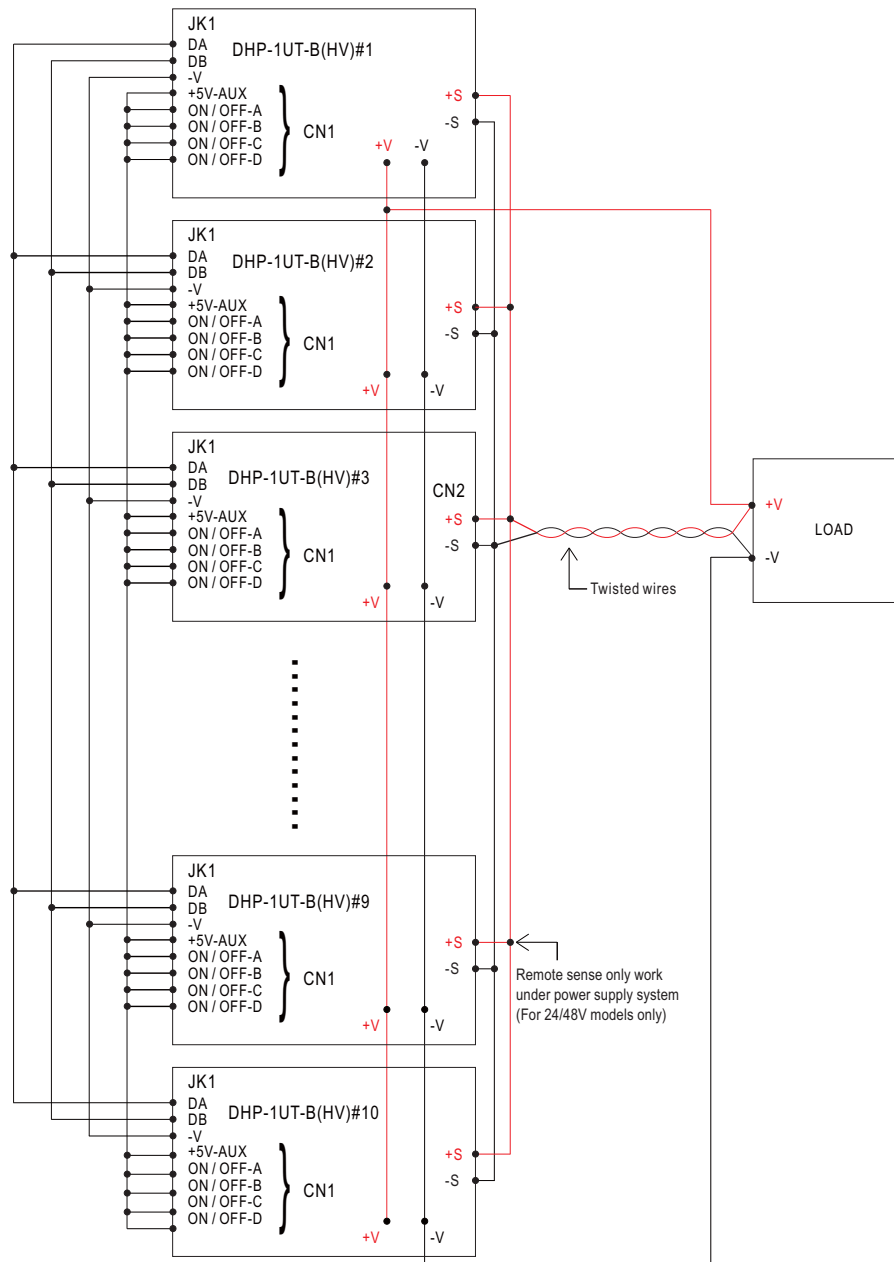
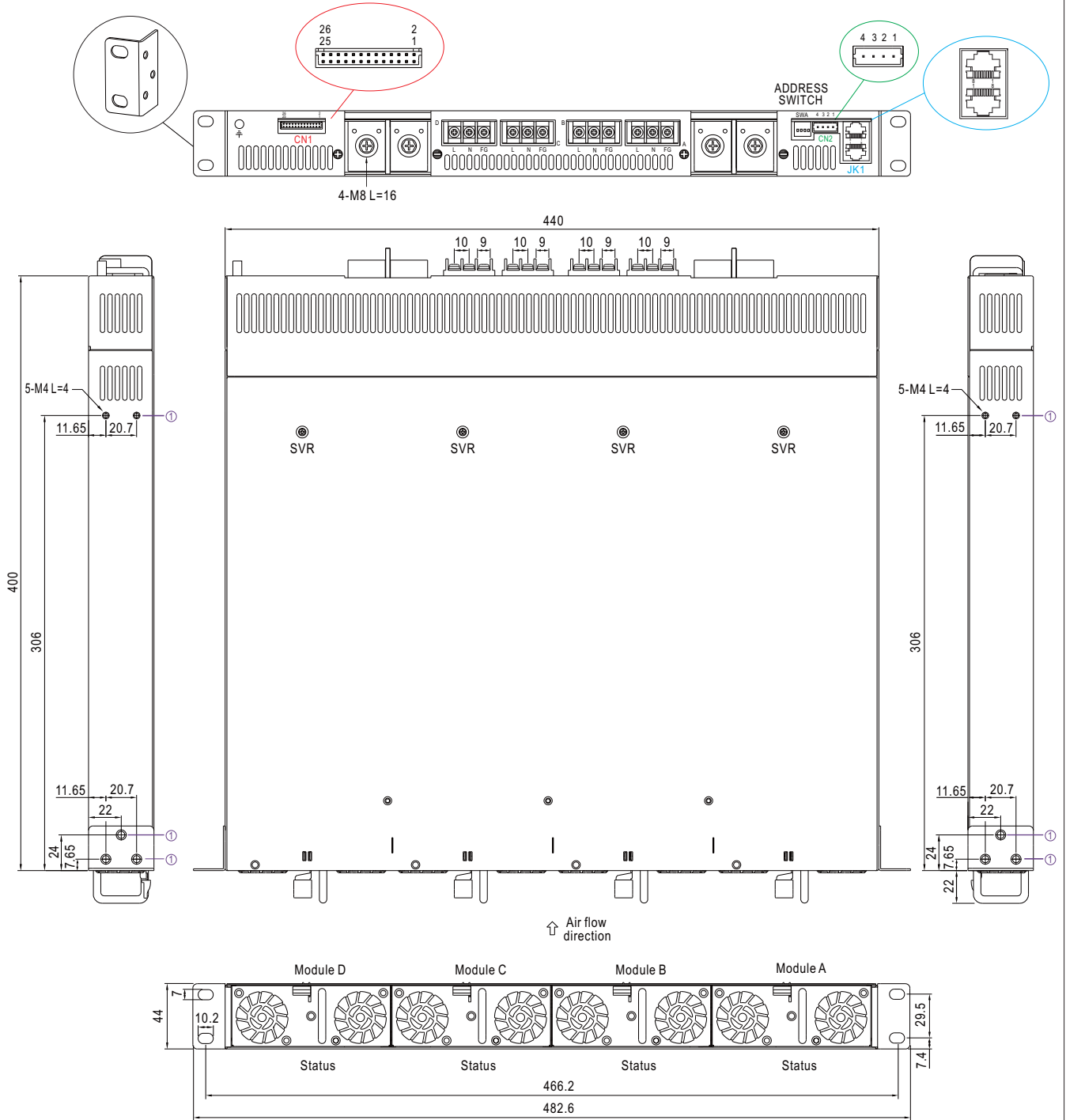

Figure 7-1 Configuration of ten rack shelf units in parallel

© Under operation of more than one rack shelf in parallel, value of Ripple & Noise may be larger than that stated in the specification at light load or no load condition. It will return to normal level once the loads draw more current than 10% of the total rating.

MECHANICAL SPECIFICATION

Case No.257B Unit:mm



※ Mounting Instruction

Hole No.	Recommended Screw Size	MAX. Penetration Depth L	Recommended mounting torque
①	M4	4mm	7~10Kgf-cm

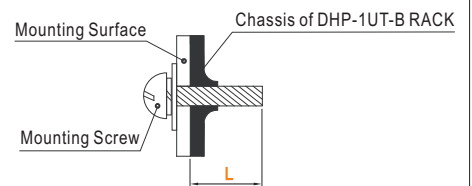

※ LED Status Indicators & Corresponding Signal at Function Pins

☉ For power supply system

LED	Description
Green	The power supply functions normally.
Red	The LED will present a constant red light when the abnormal status (OTP, OLP, fan fail and charging timeout) arises.
Red (Flashing)	The LED will flash with the red light when the internal temperature reaches 60°C; under this condition, the unit still operates normally without entering OTP. (In the meantime, an alarm signal will be sent out through the PMBus/CANBus interface.)

☉ For charger system

LED	Description
Green	Float (stage 3)
Orange	Charging (stage 1 or stage 2)
Red	The LED will present a constant red light when the abnormal status (OTP, OLP, fan fail and charging timeout) arises.
Red (Flashing)	The LED will flash with the red light when the internal temperature reaches 60°C; under this condition, the unit still operates normally without entering OTP. (In the meantime, an alarm signal will be sent out through the PMBus/CANBus interface.)

※ Connector Pin No. Assignment(CN1) : HRS DF11-26DP-2DS

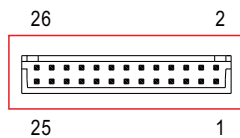

Mating Housing	HRS DF11-26DS or equivalent
Terminal	HRS DF11-**SC or equivalent

Pin No.	Function	Description
1,5,9,13	AC-OK	High (3.5 ~ 5.5V) : When the input voltage is $\geq 87V_{rms}$. Low (-0.5 ~ 0.5V) : When the input voltage is $\leq 75V_{rms}$. The maximum sourcing current is 10mA and only for output. (Note.2)
2,6,10,14	DC-OK	For power supply system High (3.5 ~ 5.5V) : When the $V_{out} \leq 77\% \pm 5\%$. Low (-0.5 ~ 0.5V) : When $V_{out} \geq 80\% \pm 5\%$. The maximum sourcing current is 10mA and only for output. (Note.2)
		For charger system High (3.5 ~ 5.5V) : When the $V_{out} \leq 66\% \pm 5\%$. Low (-0.5 ~ 0.5V) : When $V_{out} \geq 67\% \pm 5\%$. The maximum sourcing current is 10mA and only for output. (Note.2) DC OK is associated with battery low protection.
3,7,11,15	Remote ON-OFF	The unit can turn the output ON/OFF by electrical signal or dry contact between Remote ON-OFF and +5V-AUX. (Note.2) Short (4.5 ~ 5.5V) : Power ON ; Open (-0.5 ~ 0.5V) : Power OFF ; The maximum input voltage is 5.5V.
4,8,12,16	T-ALARM	High (3.5 ~ 5.5V) : When the internal temperature exceeds the limit of temperature alarm, or when fan fails. Low (-0.5 ~ 0.5V) : When the internal temperature is normal, and when fan normally works. The maximum sourcing current is 10mA and only for output(Note.2)
17,18,19,20	NC	Retain for future use.
21	+5V-AUX	Auxiliary voltage output, 4.5~5.5V, reference to GND_AUX(pin22).The maximum load current is 0.3A.
22	GND-AUX	Auxiliary voltage output GND. The signal return is isolated from the output terminals (+V & -V).
23	+12V-AUX	Auxiliary voltage output, 10.8~13.2V, referenced to GND-AUX (pin 22). The maximum load current is 0.8A. This output has the built-in "Oring diodes" and is not controlled by the remote ON/OFF control.
24	-V(Signal)	Negative output voltage. For local sense use only; It can't be connected directly to the load.
25	PC	Connection for output current programming. The current can be trimmed within its defined range. (Note.1)
26	PV	Connection for output voltage programming. The voltage can be trimmed within its defined range. (Note.1)

Note.1: Non-isolated signal, referenced to [-V(signal)].

Note.2: Isolated signal, referenced to GND-AUX.

※ Connector Pin No. Assignment(CN2) : JST SM04(4.0) B-BHS-1-TB

4 3 2 1



Mating Housing	JST BHR-04VS-1 or equivalent
Terminal	JST SBH-001T-P-0.5 or equivalent

☉ For 24V/48V models under power supply system only

1	+S	Positive sensing. The +S signal should be connected to the positive terminal of the load. The +S and -S leads should be twisted in pair to minimize noise pick-up effect. The maximum line drop compensation is 0.5V.
2	-S	Negative sensing. The -S signal should be connected to the negative terminal of the load. The -S and +S leads should be twisted in pair to minimize noise pick-up effect. The maximum line drop compensation is 0.5V.
3	+V(Signal)	Positive output voltage. For local sense use only, can't be connected directly to the load.
4	-V(Signal)	Negative output voltage. For local sense use only, can't be connected directly to the load.

※ Connector Pin No. Assignment(JK1) : RJ45 8 positions

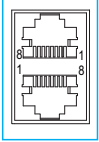

Pin No.	Function	Description
1,2	DA,DB	Differential digital signal for parallel control. (Note.1)
3	-V(signal)	Negative output voltage signal. It is for local sense and certain function reference; it cannot be connected directly to the load.
4	CONTROL	Remote ON-OFF control pin used in the PMBus interface. (Note.2)
5	+5V-AUX	+5V-AUX pin used in the PMBus interface (Note.2)
6	SDA	For PMBus model: Serial Data used in the PMBus interface. (Note.2)
	CANH	For CANBus model: Data line used in CANBus interface. (Note.2)
7	SCL	For PMBus model: Serial Clock used in the PMBus interface. (Note.2)
	CANL	For CANBus model: Data line used in CANBus interface. (Note.2)
8	GND-AUX	Auxiliary voltage output GND. The signal return is isolated from the output terminals (+V & -V).

Note.1: Non-isolated signal, referenced to [-V(signal)].

Note.2: Isolated signal, referenced to GND-AUX.

■ Accessory List

Item		Quantity
①	Remote Control mating wire (CN1) UL1061 28AWG 	1
②	Remote Sense mating wire (CN2) UL1007 26AWG 	1
③	PMBus Termination resistor (JK1) Wire color : Black & White 	1
④	CANBus Termination resistor (JK1) Wire color : Black & Red 	1
⑤	Screw (+V,-V Terminal) 	4