

4 CKT SHOWN

NOTES:

1) MATERIAL:

- 225S = NYLON 6, UL94V-2, GLOW WIRE MATERIAL COLOR: BLACK
- 225NS = NYLON 6, UL94V-2, GLOW WIRE MATERIAL COLOR: NATURAL
- 250RS = NYLON 6/6, UL94V-0, GLOW WIRE MATERIAL COLOR: RED
- 250GS = NYLON 6/6, UL94V-0, GLOW WIRE MATERIAL COLOR: GREEN
- 250BS = NYLON 6/6, UL94V-0, GLOW WIRE MATERIAL COLOR: BLUE
- 250WS = NYLON 6/6, UL94V-0, GLOW WIRE MATERIAL COLOR: NATURAL

2) FINISH: NOT APPLICABLE

3) PRODUCT SPECIFICATION: PS-5556-001

4) PACKAGING: BULK

5) PART MATES WITH MOLEX PLUG #46993 AND HEADERS #172447, #172448.

6) PART TO BE USED WITH MOLEX FEMALE TERMINAL #5556.

7) PART IS NOT DESIGNED FOR CURRENT SHARING.

8) CONNECTORS ARE NOT TO BE MATED OR UNMATED WHILE CIRCUITS ARE LIVE.

9) WIRES ARE TO BE DRESSED IN SUCH A MANNER TO ALLOW THE TERMINALS TO FLOAT FREELY IN THE POCKET.

10) PART CONFORMS TO CLASS "B" REQUIREMENTS OF COSMETIC SPECIFICATION PS-45499-002 WITH THE EXCEPTION OF DISCOLORATION, FLASH AND SINK MEET

CLASS "C" REQUIREMENTS.  
 TO BE MEASURED AT SURFACE Z

12) TEXT ON PART IS FOR REFERENCE ONLY. TEXT AND TEXT LOCATION MAY VARY DEPENDING ON PART NUMBER AND/OR TOOL.

13) APPLICATION SPECIFICATION :469920000-AS.

14) BUBBLE IS ACCEPTABLE ON LATCH AREA.

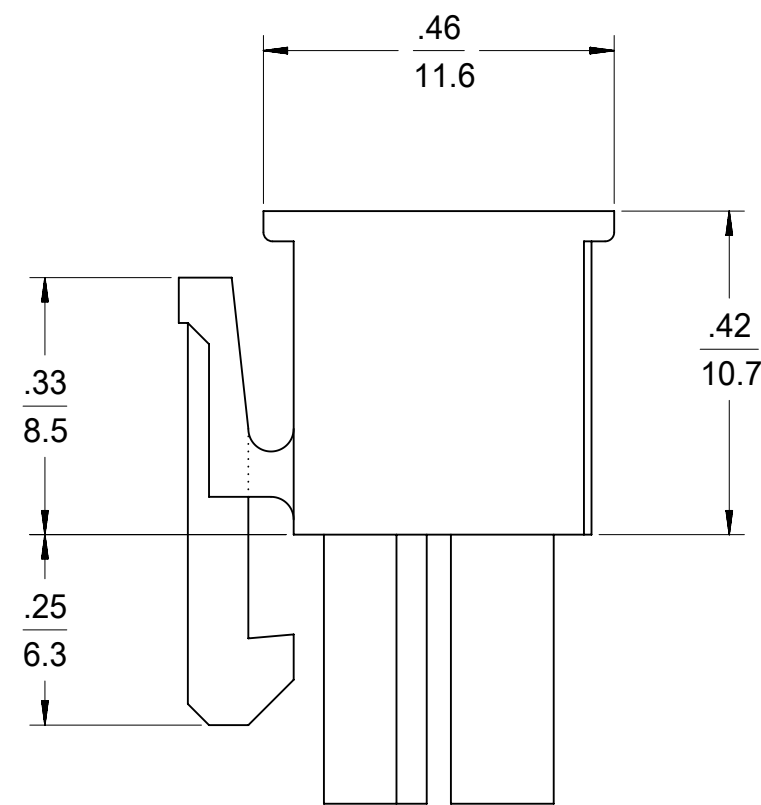
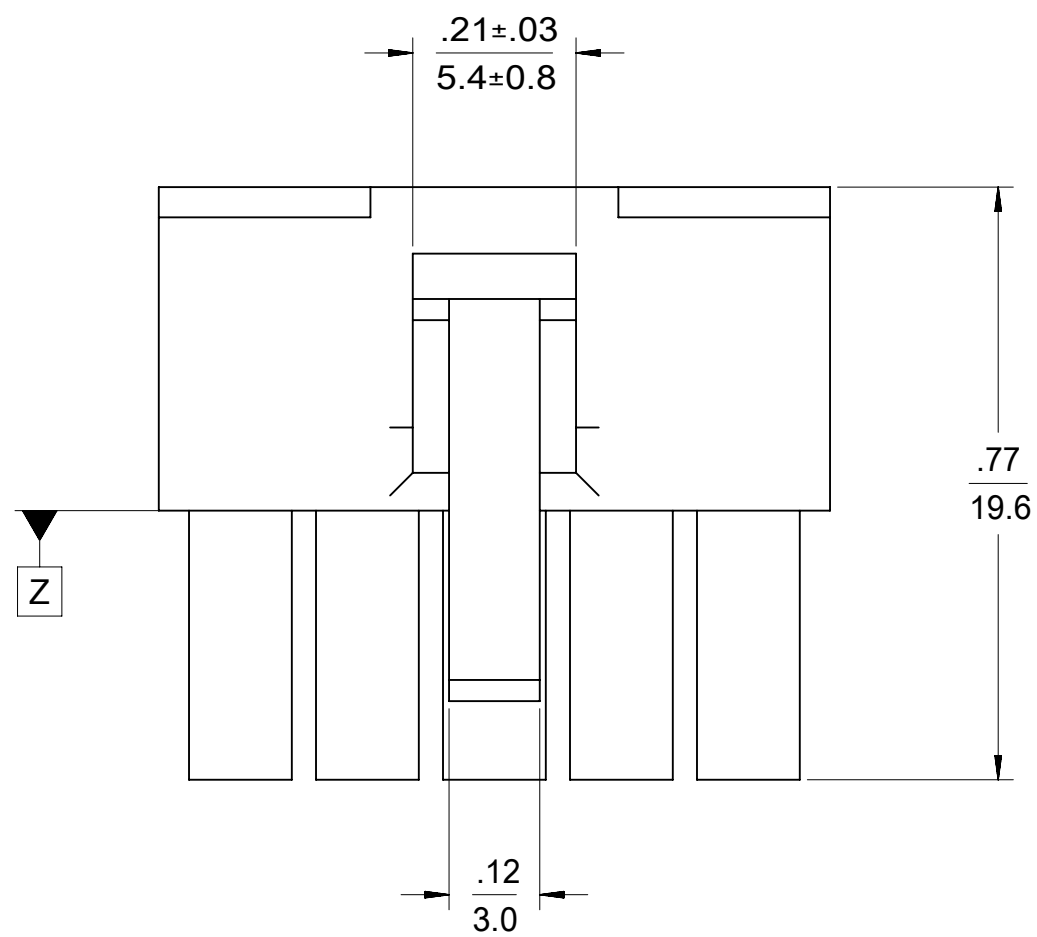

4-24 CKT

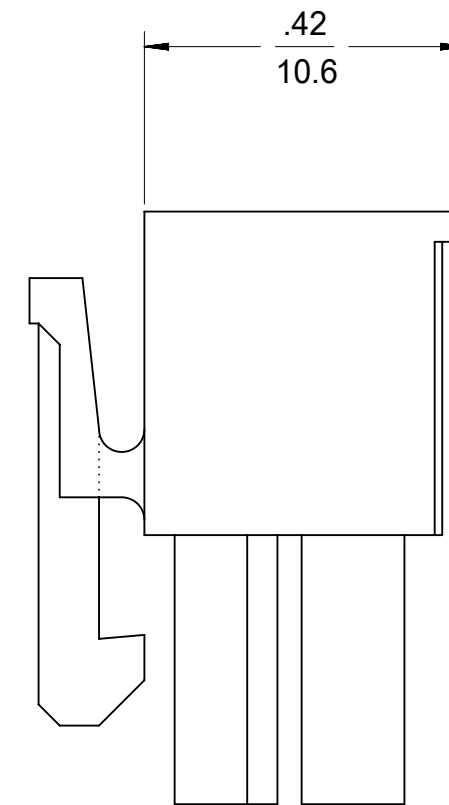

2 CKT ONLY

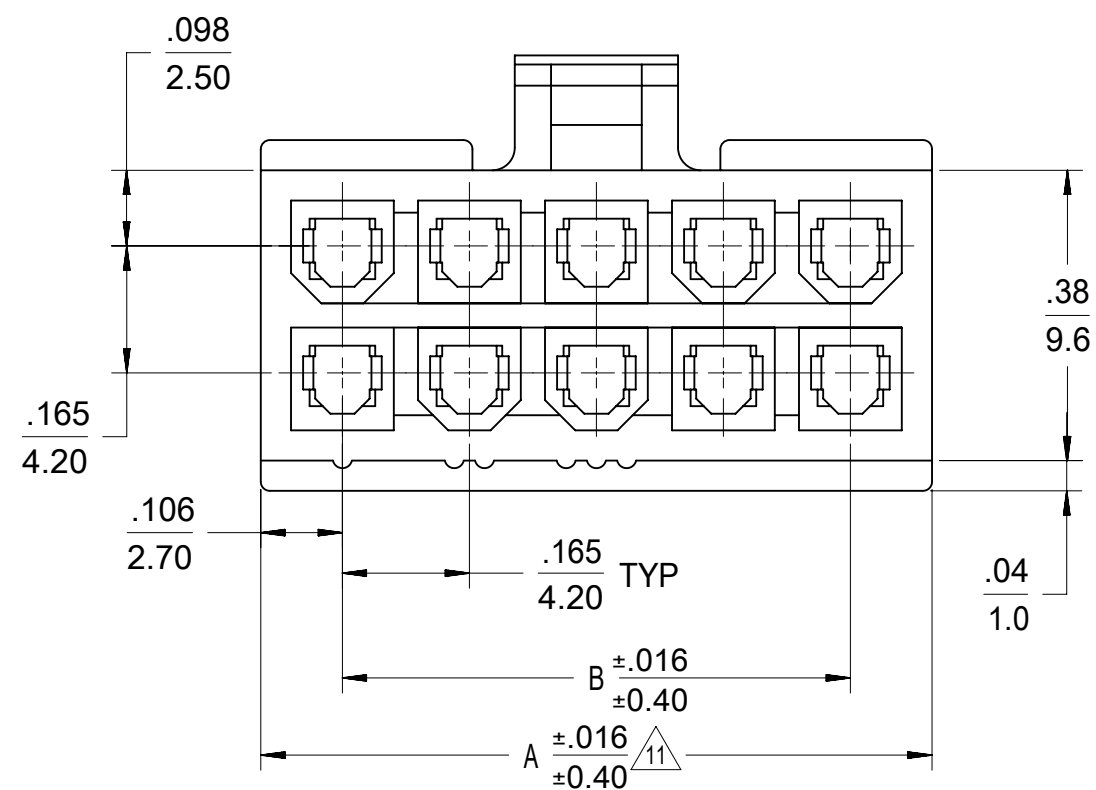

LEGEND

- 46992 -\*\*\* 0
- CIRCUIT SIZE
- MATERIAL (SEE NOTE 1)
- 0 = 225NS
  - 1 = 225S
  - 2 = 250RS
  - 3 = 250GS
  - 4 = 250BS
  - 5 = 250WS
- CONFIGURATION DUAL ROW

THIS DRAWING CONTAINS INFORMATION THAT IS PROPRIETARY TO MOLEX ELECTRONIC TECHNOLOGIES, LLC AND SHOULD NOT BE USED WITHOUT WRITTEN PERMISSION									
DIMENSION UNITS		SCALE		CURRENT REV DESC:					
mm		NTS		EC NO: 719028					
GENERAL TOLERANCES (UNLESS SPECIFIED)				DRWN: JERRYW8 2022/08/23				MINIFIT JR RECEPTACLE HOUSING DUAL ROW, 2-24 CKT	
4 PLACES		±		CHK'D: XQZHANG 2022/09/01					
3 PLACES		±		APPR: XQZHANG 2022/09/01				PRODUCT CUSTOMER DRAWING	
2 PLACES		± 0.25 ± 0.015		INITIAL REVISION:				DOCUMENT NUMBER	
1 PLACE		± 0.38 ±		DRWN: NNGUYEN 2013/04/12				SD-46992-0000	
0 PLACES		±		APPR: FSMITH 2014/05/16				PSD 000 A9	
ANGULAR TOL ± 3.0 °				THIRD ANGLE PROJECTION		DRAWING		SHEET NUMBER	
DRAFT WHERE APPLICABLE MUST REMAIN WITHIN DIMENSIONS				C-SIZE		SERIES		MATERIAL NUMBER	
						46992		CUSTOMER	
						GENERAL MARKET		SEE TABLE	



2 CKT.



14 CKT.

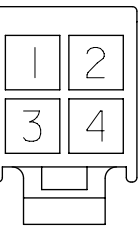

4 CKT.

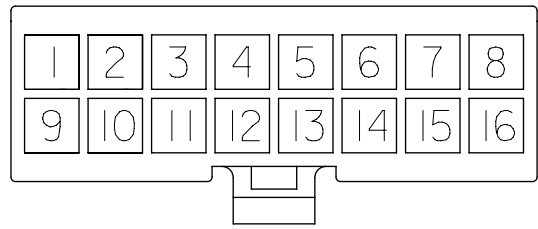

16 CKT.

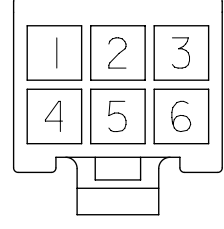

6 CKT.

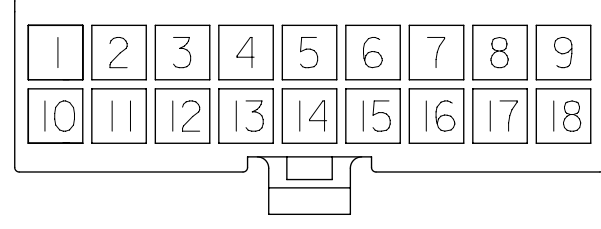

18 CKT.

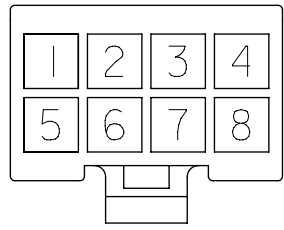

8 CKT.

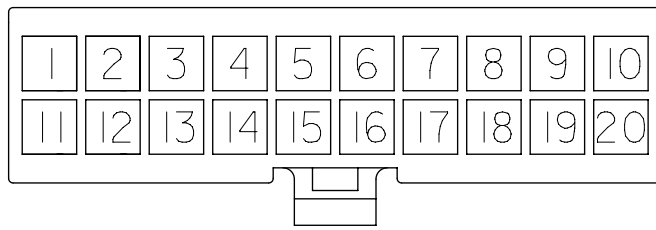

20 CKT.

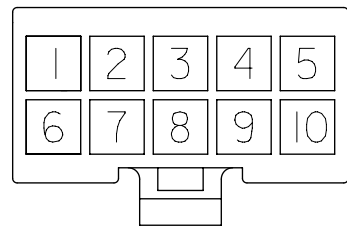

10 CKT.

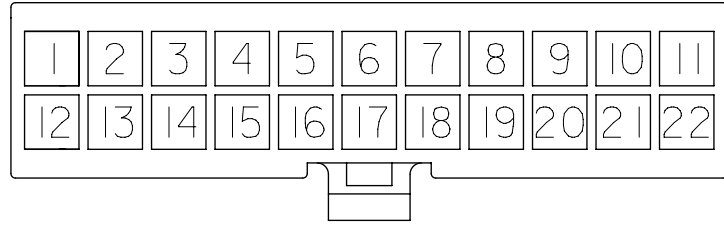

22 CKT.

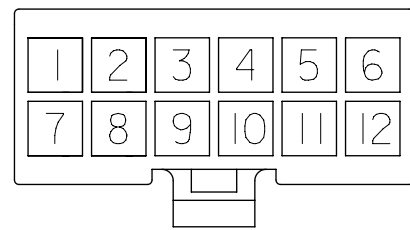

12 CKT.

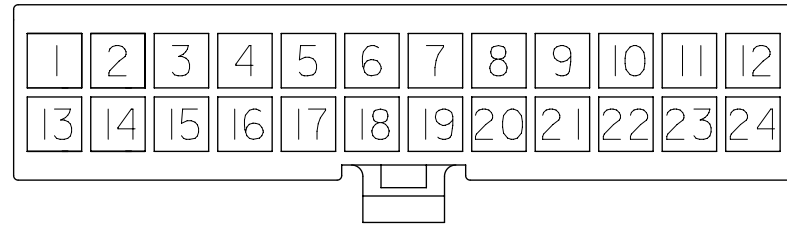

24 CKT.

**CIRCUIT SIZE LAYOUT  
(NOT TO SCALE)**

PART NUMBER	CKT SIZE	DIM "A"	DIM "B"	MATERIAL CODE & COLOR
46992-0240	02	.21/5.40	--	250BS BLUE (V0)
46992-0440	04	.38/9.60	.165/4.20	
46992-0640	06	.54/13.8	.331/8.40	
46992-0840	08	.71/18.0	.496/12.60	
46992-1040	10	.87/22.2	.661/16.8	
46992-1240	12	1.04/26.4	.827/21.00	
46992-0250	02	.21/5.40	--	250WS NATURAL (V0)
46992-0450	04	.38/9.60	.165/4.20	
46992-0650	06	.54/13.8	.331/8.40	
46992-0850	08	.71/18.0	.496/12.60	
46992-1050	10	.87/22.2	.661/16.8	
46992-1250	12	1.04/26.4	.827/21.00	

PART NUMBER	CKT SIZE	DIM "A"	DIM "B"	MATERIAL CODE & COLOR
46992-0200	02	.21/5.40	--	225NS NATURAL (V2)
46992-0400	04	.38/9.60	.165/4.20	
46992-0600	06	.54/13.8	.331/8.40	
46992-0800	08	.71/18.0	.496/12.60	
46992-1000	10	.87/22.2	.661/16.8	
46992-1200	12	1.04/26.4	.827/21.00	
46992-1400	14	1.21 / 30.6	.992/25.20	
46992-1600	16	1.37 / 34.8	1.158/29.40	
46992-1800	18	1.54 / 39.0	1.323/33.60	
46992-2000	X 20	1.70 / 43.2	1.488/37.80	
46992-2200	X 22	1.87 / 47.4	1.654/42.00	
46992-2400	X 24	2.03 / 51.6	1.819/46.20	
46992-0210	02	.21/5.40	--	225S BLACK (V2)
46992-0410	04	.38/9.60	.165/4.20	
46992-0610	06	.54/13.8	.331/8.40	
46992-0810	08	.71/18.0	.496/12.60	
46992-1010	10	.87/22.2	.661/16.8	
46992-1210	12	1.04/26.4	.827/21.00	
46992-1410	14	1.21 / 30.6	.992/25.20	
46992-1610	16	1.37 / 34.8	1.158/29.40	
46992-1810	18	1.54 / 39.0	1.323/33.60	
46992-2010	X 20	1.70 / 43.2	1.488/37.80	
46992-2210	X 22	1.87 / 47.4	1.654/42.00	
46992-2410	24	2.03 / 51.6	1.819/46.20	
46992-0220	02	.21/5.40	--	250RS RED (V0)
46992-0420	04	.38/9.60	.165/4.20	
46992-0620	06	.54/13.8	.331/8.40	
46992-0820	08	.71/18.0	.496/12.60	
46992-1020	10	.87/22.2	.661/16.8	
46992-1220	12	1.04/26.4	.827/21.00	
46992-0230	02	.21/5.40	--	250GS GREEN (V0)
46992-0430	04	.38/9.60	.165/4.20	
46992-0630	06	.54/13.8	.331/8.40	
46992-0830	08	.71/18.0	.496/12.60	
46992-1030	10	.87/22.2	.661/16.8	
46992-1230	12	1.04/26.4	.827/21.00	

X = NOT TOOLED

THIS DRAWING CONTAINS INFORMATION THAT IS PROPRIETARY TO MOLEX ELECTRONIC TECHNOLOGIES, LLC AND SHOULD NOT BE USED WITHOUT WRITTEN PERMISSION

CONT

DIMENSION UNITS	SCALE	CURRENT REV DESC:	<b>molex</b>		
mm	NTS				
GENERAL TOLERANCES (UNLESS SPECIFIED)			<b>MINIFIT JR</b> RECEPTACLE HOUSING DUAL ROW, 2-24 CKT  PRODUCT CUSTOMER DRAWING  DOCUMENT NUMBER: <b>SD-46992-0000</b>   DOC TYPE: PSD   DOC PART: 000   REVISION: A9  MATERIAL NUMBER: SEE TABLE   CUSTOMER: GENERAL MARKET   SHEET NUMBER: 2 OF 2		
	MM	INCH			
4 PLACES	±	±			
3 PLACES	±	± 0.01			
2 PLACES	± 0.25	± 0.015			
1 PLACE	± 0.38	±			
0 PLACES	±	±			
ANGULAR TOL	± 3.0 °				
DRAFT WHERE APPLICABLE MUST REMAIN WITHIN DIMENSIONS			THIRD ANGLE PROJECTION DRAWING SERIES: <b>C-SIZE 46992</b>		

EC NO: 719028  
DRWN: JERRYW8 2022/08/23  
CHK'D: XQZHANG 2022/09/01  
APPR: XQZHANG 2022/09/01  
INITIAL REVISION:  
DRWN: NNGUYEN 2013/04/12  
APPR: FSMITH 2014/05/16