

4 PIN DIP ZERO-CROSS TRIAC DRIVER PHOTOCOUPLER ELT304X, ELT306X, ELT308X Series

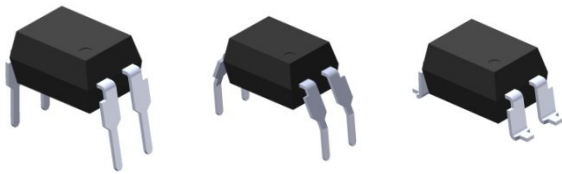

Features:

- Peak breakdown voltage
 - 400V: ELT304X
 - 600V: ELT306X
 - 800V: ELT308X
- High isolation voltage between input and output (Viso=5000 V rms)
- Zero voltage crossing
- Pb free and RoHS compliant.
- UL and cUL approved(No. E214129)
- VDE approved (No. 40028391)
- SEMKO approved
- NEMKO approved
- DEMKO approved
- FIMKO approved

Schematic

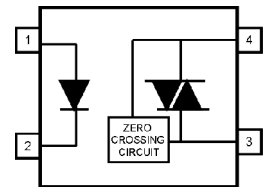

Pin Configuration

1. Anode
2. Cathode
3. Terminal
4. Terminal

Description

The ELT304X, ELT306X and ELT308X series of devices each consist of a GaAs infrared emitting diode optically coupled to a monolithic silicon zero voltage crossing photo triac.

They are designed for use with a discrete power triac in the interface of logic systems to equipment powered from 110 to 380 VAC lines, such as solid-state relays, industrial controls, motors, solenoids and consumer appliances.

Applications

- Solenoid/valve controls
- Light controls
- Static power switch
- AC motor drivers
- E.M. contactors
- Temperature controls
- AC Motor starters

Absolute Maximum Ratings (Ta=25)

Parameter		Symbol	Rating	Unit
Input	Forward current	I_F	60	mA
	Reverse voltage	V_R	6	V
	Power dissipation	P_D	100	mW
Output	Off-state Output Terminal Voltage	ELT304X	400	V
		ELT306X	600	
		ELT308X	800	
	Peak Repetitive Surge Current	I_{TSM}	1	A
	Power dissipation	P_C	300	mW
Total power dissipation		P_{TOT}	330	mW
Isolation voltage ^{*1}		V_{ISO}	5000	Vrms
Operating temperature		T_{OPR}	-55 to 100	
Storage temperature		T_{STG}	-55 to 125	
Soldering Temperature ^{*2}		T_{SOL}	260	

Notes:

*1 AC for 1 minute, R.H.= 40 ~ 60% R.H. In this test, pins 1 & 2 are shorted together, and pins 3 & 4 are shorted together.

*2 For 10 seconds

Electro-Optical Characteristics (Ta=25 unless specified otherwise)

Input

Parameter	Symbol	Min.	Typ.*	Max.	Unit	Condition
Forward Voltage	V_F	-	-	1.5	V	$I_F = 30\text{mA}$
Reverse Leakage current	I_R	-	-	10	μA	$V_R = 6\text{V}$

Output

Parameter	Symbol	Min.	Typ.*	Max.	Unit	Condition
Peak Blocking Current	I_{DRM}	-	-	100	nA	$V_{\text{DRM}} = \text{Rated } V_{\text{DRM}}$ $I_F = 0\text{mA}$
				500		
Peak On-state Voltage	V_{TM}	-	-	3	V	$I_{\text{TM}} = 100\text{mA peak}$, $I_F = \text{Rated } I_{\text{FT}}$
Critical Rate of Rise off-state Voltage	dv/dt	1000	-	-	V/ μs	$V_{\text{PEAK}} = \text{Rated } V_{\text{DRM}}$, $I_F = 0$ (Fig. 10)
		600	-	-		
Inhibit Voltage (MT1-MT2 voltage above which device will not trigger)	V_{INH}	-	-	20	V	$I_F = \text{Rated } I_{\text{FT}}$
Leakage in Inhibited State	I_{DRM2}	-	-	500	μA	$I_F = \text{Rated } I_{\text{FT}}$, $V_{\text{DRM}} = \text{Rated } V_{\text{DRM}}$, off state

Transfer Characteristics

Parameter	Symbol	Min.	Typ.*	Max.	Unit	Condition
LED Trigger Current	I_{FT}	-	-	15	mA	Main terminal Voltage=3V
				10		
				5		
Holding Current	I_H	-	280	-	μA	

* Typical values at $T_a = 25^\circ\text{C}$

Typical Electro-Optical Characteristics Curves

Figure 1. Forward Current vs Forward Voltage

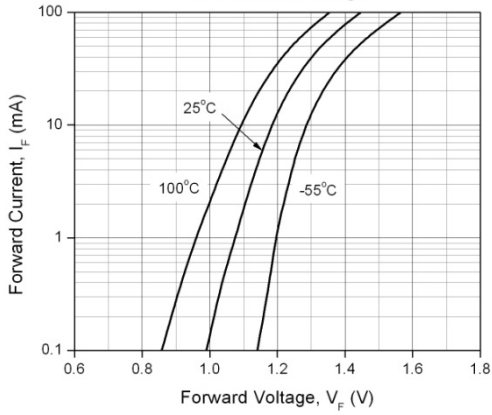

Figure 2. On-State Characteristics

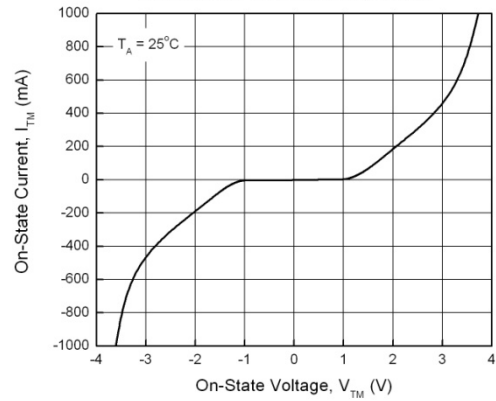

Figure 3. Holding Current vs. Ambient Temperature

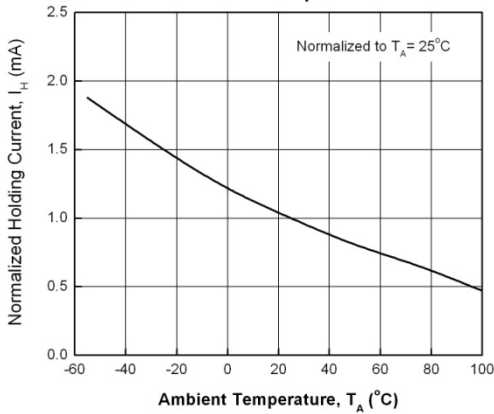

Figure 4. LED Current Required to Trigger vs. LED Pulse Width

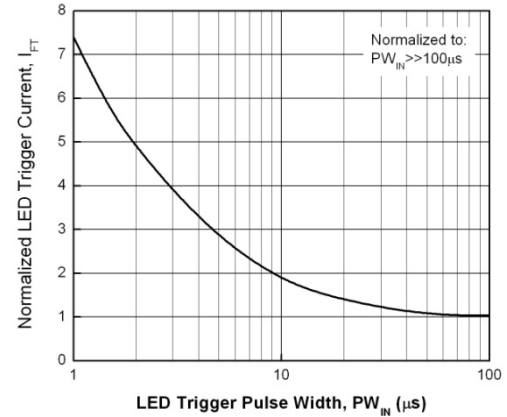

Figure 5. Leakage Current vs. Ambient Temperature

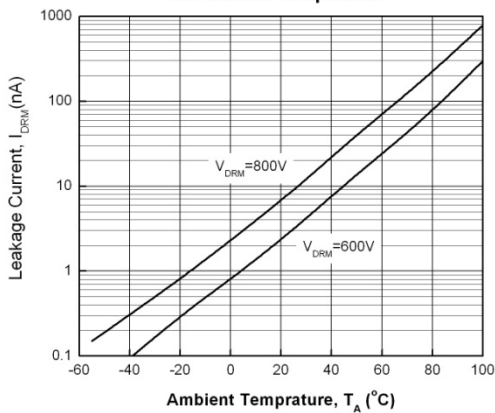

Figure 6. LED Trigger Current vs. Ambient Temperature

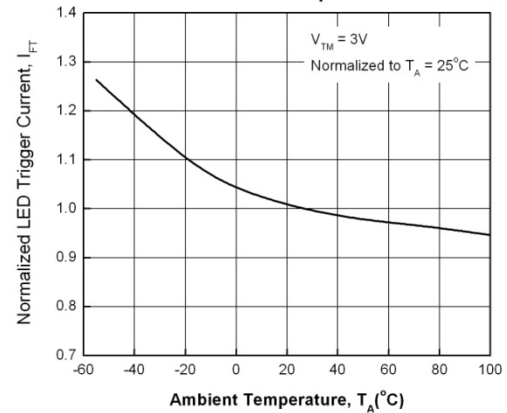

Figure 7. Off-State Output Terminal Voltage vs. Ambient Temperature

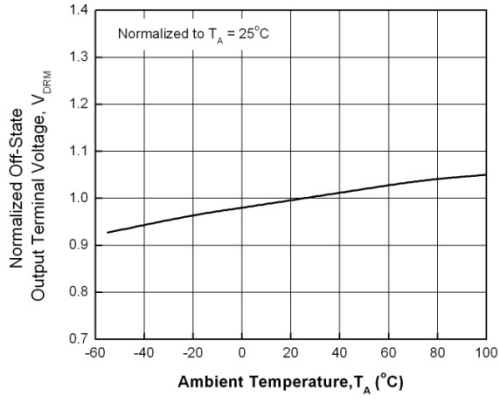

Figure 8. Leakage in Inhibit State vs. Ambient Temperature

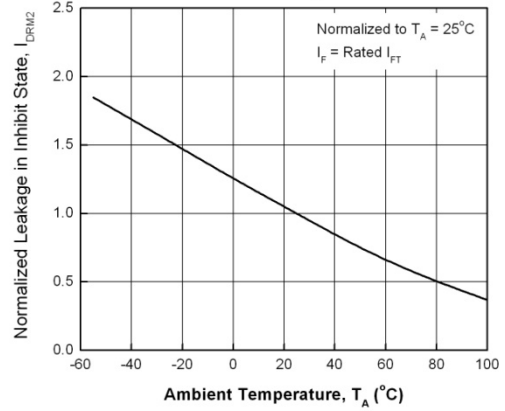

Figure 9. Inhibit Voltage vs. Ambient Temperature

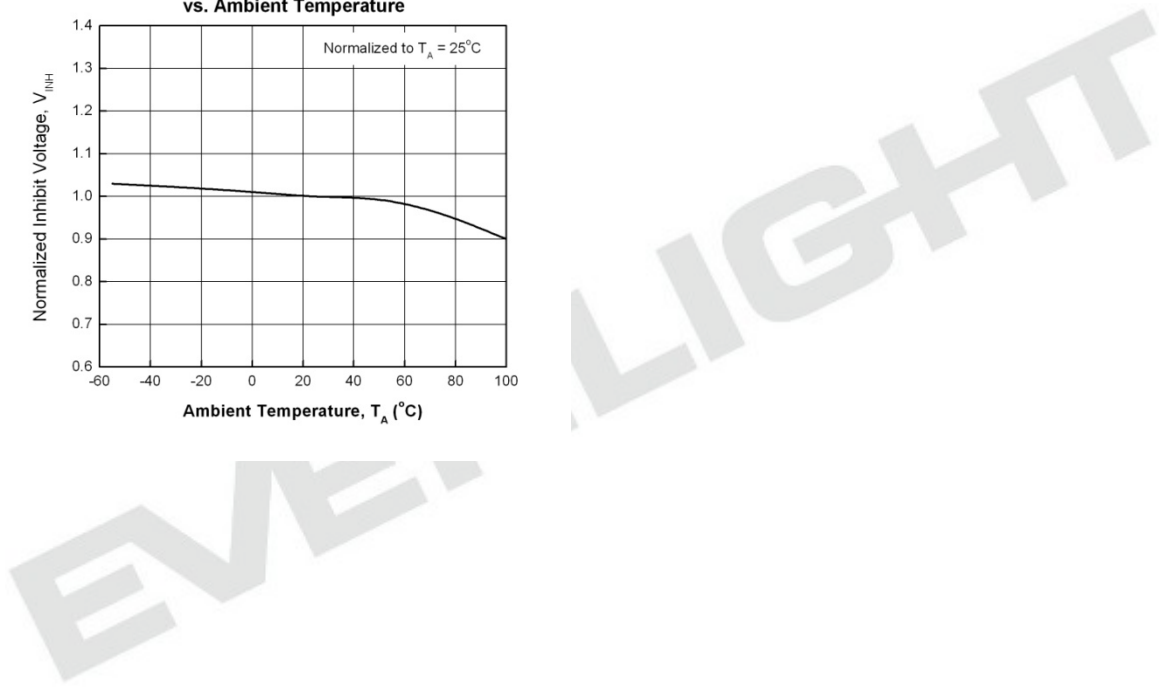
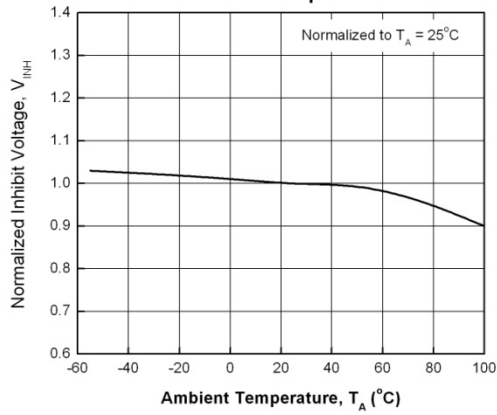
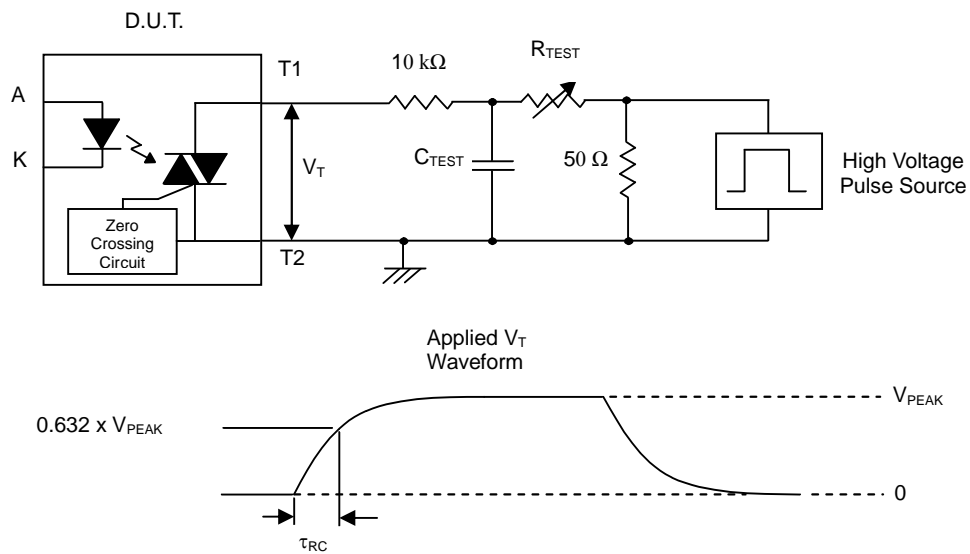

Figure 10. Static dv/dt Test Circuit & Waveform



Measurement Method

The high voltage pulse is set to the required V_{PEAK} value and applied to the D.U.T. output side through the RC circuit above. LED current is not applied. The waveform V_T is monitored using a x100 scope probe. By varying R_{TEST} , the dv/dt (slope) is increased, until the D.U.T. is observed to trigger (waveform collapses). The dv/dt is then decreased until the D.U.T. stops triggering. At this point, τ_{RC} is recorded and the dv/dt calculated.

$$dv/dt = \frac{0.632 \times V_{PEAK}}{\tau_{RC}}$$

For example, $V_{PEAK} = 600V$ for ELT306X series. The dv/dt value is calculated as follows:

$$dv/dt = \frac{0.63 \times 600}{\tau_{RC}} = \frac{378}{\tau_{RC}}$$

Order Information

Part Number

ELT304X(Y)(Z)-V
 or **ELT306X(Y)(Z)-V**
 or **ELT308X(Y)(Z)-V**

Note

Note

X = Part No. (1, 2, or 3)

Y = Lead form option (S, S1, M or none)

Z = Tape and reel option (TA, TB, TU, TD or none).

V = VDE safety approved option

Option	Description	Packing quantity
None	Standard DIP-4	100 units per tube
M	Wide lead bend (0.4 inch spacing)	100 units per tube
S (TA)	Surface mount lead form + TA tape & reel option	1000 units per reel
S (TB)	Surface mount lead form + TB tape & reel option	1000 units per reel
S1 (TA)	Surface mount lead form (low profile) + TA tape & reel option	1000 units per reel
S1 (TB)	Surface mount lead form (low profile) + TB tape & reel option	1000 units per reel
S (TU)	Surface mount lead form + TU tape & reel option	1500 units per reel
S (TD)	Surface mount lead form + TD tape & reel option	1500 units per reel
S1 (TU)	Surface mount lead form (low profile) + TU tape & reel option	1500 units per reel
S1 (TD)	Surface mount lead form (low profile) + TD tape & reel option	1500 units per reel

Package Dimension (Dimensions in mm)

Standard DIP Type

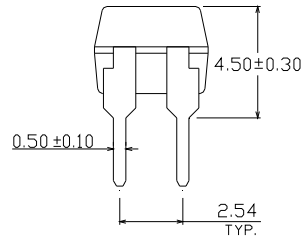
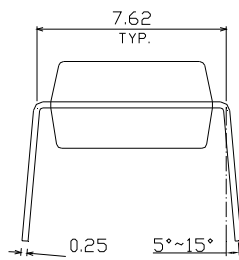
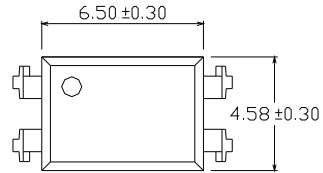

Option M Type

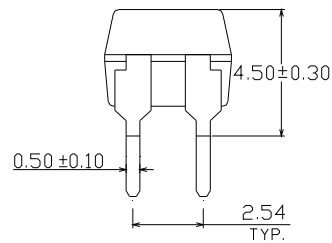
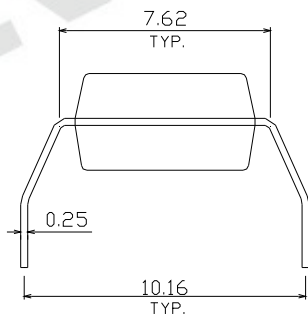
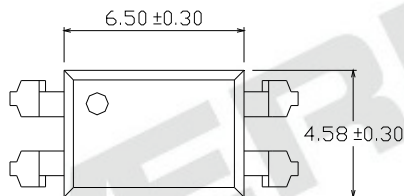

Option S Type

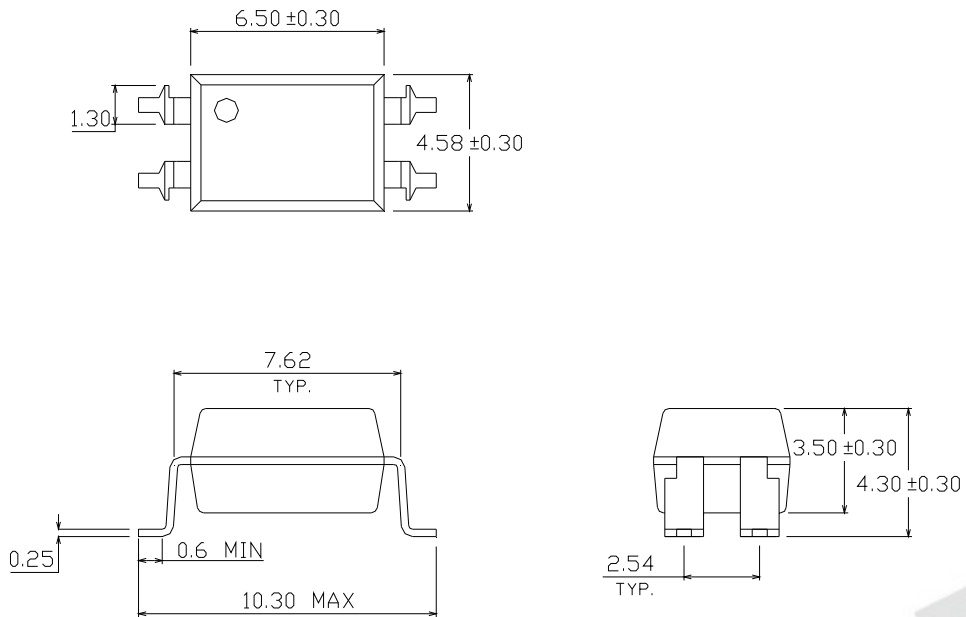

Option S1 Type

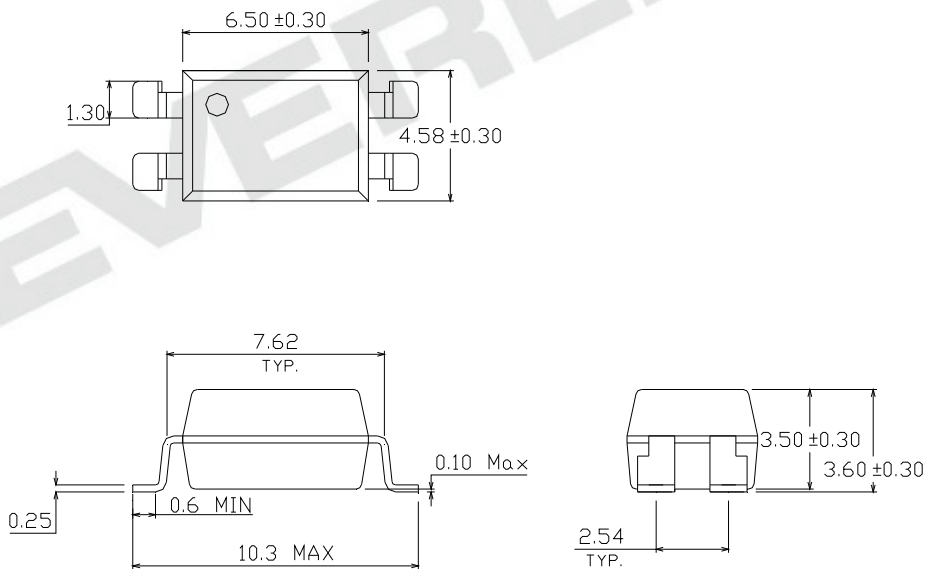

Recommended pad layout for surface mount leadform

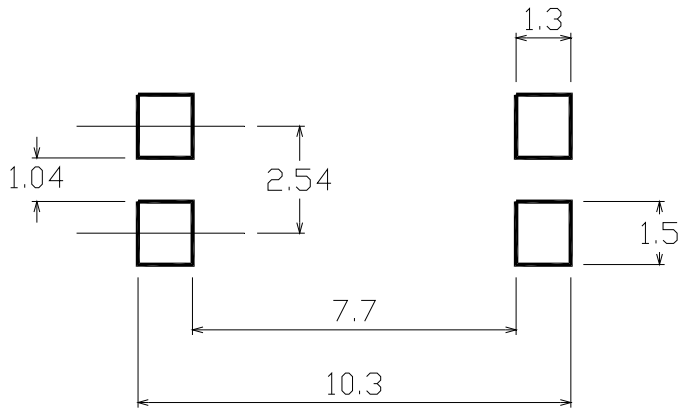

Device Marking



Notes

- EL denotes Everlight
- T3083 denotes Device Number
- Y denotes 1 digit Year code
- WW denotes 2 digit Week code
- V denotes VDE option

Tape & Reel Packing Specifications

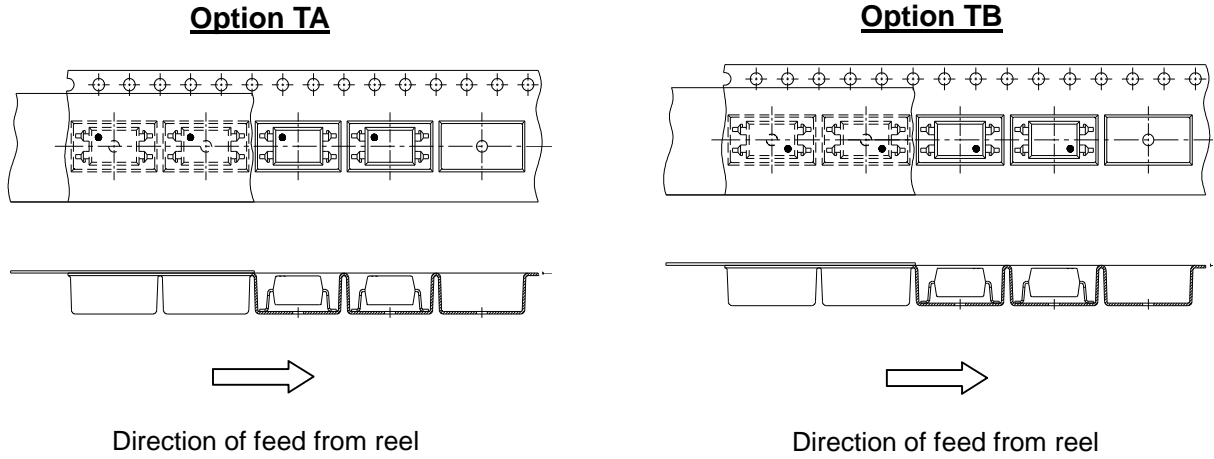

Tape dimensions

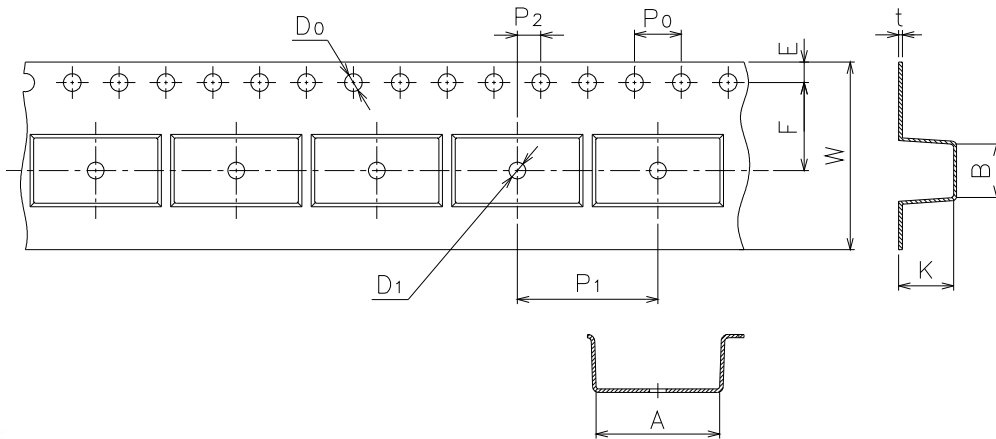

Dimension No.	A	B	Do	D1	E	F
Dimension (mm)	10.5±0.1	4.65±0.1	1.55±0.1	1.50±0.1	1.75±0.1	7.5±0.1

Dimension No.	Po	P1	P2	t	W	K
Dimension (mm)	4.0±0.1	12.0±0.1	2.0±0.1	0.35±0.1	16.0±0.3	4.75±0.1

Option TD

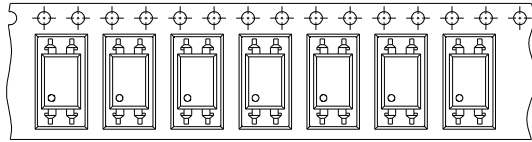

Direction of feed from reel

Option TU

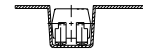
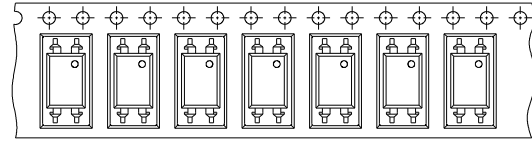

Direction of feed from reel

Tape dimensions

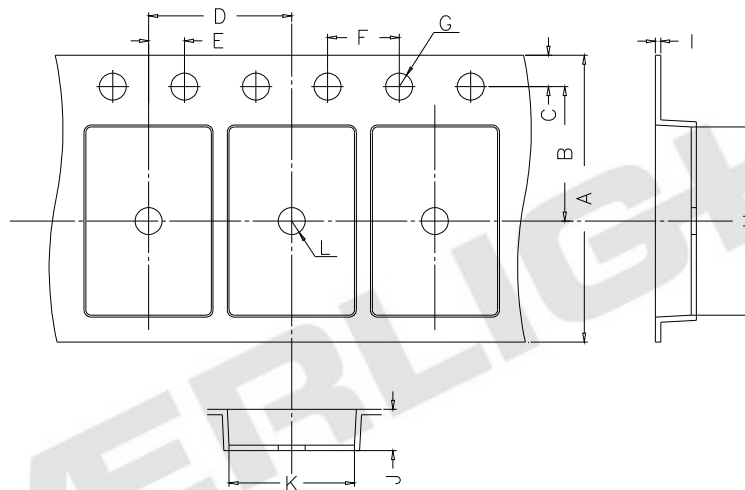

Dimension No.	A	B	C	D	E	F
Dimension(mm)	16.00±0.3	7.5±0.1	1.75±0.1	8.0±0.1	2.0±0.1	4.0±0.1
Dimension No.	G	H	I	J	K	L
Dimension(mm)	1.55±0.05	10.4±0.1	0.4±0.05	4.60±0.1	5.1±0.1	1.55±0.05

Precautions for Use

1. Soldering Condition

1.1 (A) Maximum Body Case Temperature Profile for evaluation of Reflow Profile

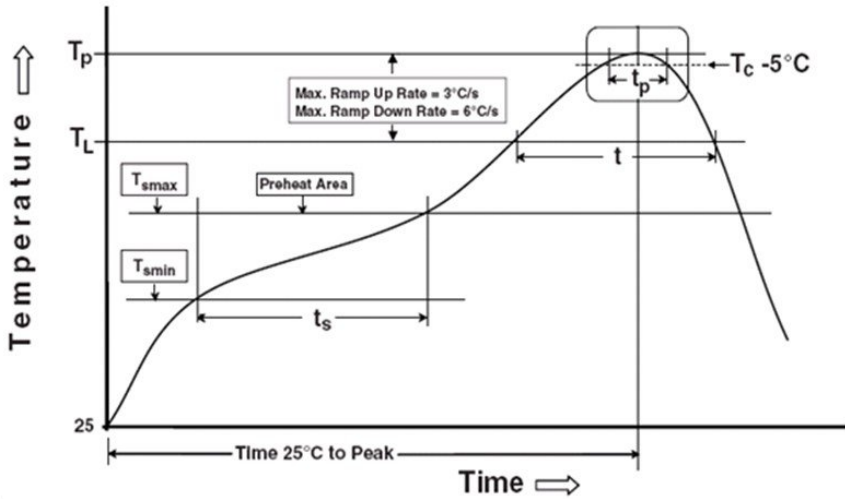

Note:

Reference: IPC/JEDEC J-STD-020D

Preheat

Temperature min (T_{smin})	150 °C
Temperature max (T_{smax})	200°C
Time (T_{smin} to T_{smax}) (t_s)	60-120 seconds
Average ramp-up rate (T_{smax} to T_p)	3 °C/second max

Other

Liquidus Temperature (T_L)	217 °C
Time above Liquidus Temperature (t_L)	60-100 sec
Peak Temperature (T_p)	260°C
Time within 5 °C of Actual Peak Temperature: $T_p - 5^\circ\text{C}$	30 s
Ramp- Down Rate from Peak Temperature	6°C /second max.
Time 25°C to peak temperature	8 minutes max.
Reflow times	3 times

DISCLAIMER

1. Above specification may be changed without notice. EVERLIGHT will reserve authority on material change for above specification.
2. When using this product, please observe the absolute maximum ratings and the instructions for using outlined in these specification sheets. EVERLIGHT assumes no responsibility for any damage resulting from use of the product which does not comply with the absolute maximum ratings and the instructions included in these specification sheets.
3. These specification sheets include materials protected under copyright of EVERLIGHT corporation. Please don't reproduce or cause anyone to reproduce them without EVERLIGHT's consent.

EVERLIGHT