

ECS Series

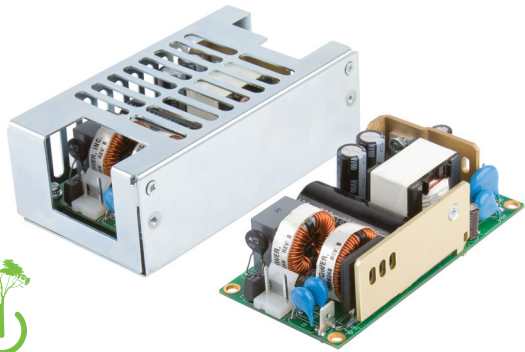

GREEN XP POWER

- IT & Medical Safety Approvals
- 65/80/100 W – Convection-cooled Ratings
- Class I & Class II Construction
- Industry Standard 2" x 4" Package
- <0.5 W No Load Input Power
- Low Leakage Current
- 3 Year Warranty

Specification

Input

Input Voltage	• 80-264 VAC derate output power <90 VAC, see derating curves
Input Frequency	• 47-63 Hz ⁽¹⁾
Input Current	• 65 W: 1.0/0.6 A typical at 115/230 VAC 100 W: 1.5/0.9 A typical at 115/230 VAC, 130 W: 1.9/1.1 A typical at 115/230 VAC full load
Inrush Current	• 40 A max at 230 VAC, cold start at 25 °C
Power Factor	• EN61000-3-2, class A
No Load Input Power	• <0.5 W
Earth Leakage Current	• 65/130 W: 260 µA at 264 VAC/60 Hz max 100 W: 230 µA at 264 VAC/60 Hz max
Input Protection	• Internal T3.15 A/250 V fuse in line and neutral

Output

Output Voltage	• 12-48 VDC (see tables)
Output Voltage Trim	• ±10%
Initial Set Accuracy	• ±1%
Minimum Load	• No minimum load required
Start Up Delay	• 1 s typical
Start Up Rise Time	• 50 ms
Hold Up Time	• 16 ms min at 115 VAC
Drift	• ±0.2% after 20 min warm up
Line Regulation	• ±0.5% max
Load Regulation	• ±1%
Over/Undershoot	• 5% typical
Transient Response	• 4% max. deviation, recovery to within 1% in 500 µs for a 50-75-50% load change
Ripple & Noise	• 1% pk-pk, 20 MHz bandwidth
Overvoltage Protection	• 115-140% Vnom, recycle input to reset
Overload Protection	• 110-160%
Short Circuit Protection	• Continuous trip and restart (hiccup mode)
Temperature Coefficient	• 0.05%/°C

Notes

1. ECS65US12 has 400Hz IT approval.

General

Efficiency	• Up to 90% model dependent
Isolation	• 4000 VAC Input to Output, 2 x MOPP, 1500 VAC Input to Ground, 1 x MOPP, 500 VDC Output to Ground, 1 x MOPP
Switching Frequency	• 65 KHz typical
Power Density	• 65 W: 7.7 W/in ³ , 100 W: 10 W/in ³ , 130 W: 13 W/in ³
MTBF	• 65 W: 850 kHrs, 100 W: 834 kHrs, 130 W: 715 kHrs to MIL-HDBK-217F at 25 °C, GB

Environmental

Operating Temperature	• -20 °C (-40 °C, ECS130) to +70 °C derate linearly from +50 °C at 2.5%/°C to 50% load at +70 °C.
Cooling	• Convection & fan cooled ratings (see tables)
Operating Humidity	• 95% RH, non-condensing
Storage Temperature	• -40 °C to +85 °C
Operating Altitude	• 65-100 W: 3000 m, 130 W: 5000m
Shock	• 30 g pk, half sine, 6 axes
Vibration	• 2 g rms, 5 Hz to 500 Hz, 3 axes

EMC & Safety

Low Voltage PSU EMC Emissions	• EN61204-3, high severity level • EN55011/32 level B conducted • EN55011/32 level A radiated, level B Suffix '-B' models
Harmonic Currents	• EN61000-3-2, class A
Voltage Flicker	• EN61000-3-3
ESD Immunity	• EN61000-4-2, ±6 kV Contact, ±15 kV Air Discharge, Perf Criteria A
Radiated Immunity	• EN61000-4-3, level 3 Perf Criteria A
EFT/Burst	• EN61000-4-4, level 3 Perf Criteria A
Surge	• EN61000-4-5, installation class 3 Perf Criteria A
Conducted Immunity	• EN61000-4-6, level 3 Perf Criteria A
Dips & Interruptions	• EN61000-4-11, 30% 10 ms, 60% 100 ms, 100% 5000 ms, Perf Criteria A, B, B, • EN60601-1-2, 30% 500 ms, 60% 100 ms, 100% 10 ms, 100% 5000 ms, Perf Criteria A, A, A, B - 230 VAC. Consult longform datasheet for 115 V operation.
Safety Approvals	• IEC60950-1:2005 Ed 2 / IEC62368-1:2014 UL 62368-1 & CAN/CSA C22.2 No. 62368-1-14, EN62368-1:2014/A11:2017 IEC60601-1 CB report, CSA 22.2 No. 60601-1, ANSI/AMMI ES60601-1, TUV 60601-1, including risk management
Equipment Protection Class	• Class I & II (ECS65 Non '-B' models, Class I only)

Output Power	Output Voltage	Output Current	Model Number ⁽¹⁾
65 W	12.0 VDC	5.4 A	ECS65US12
65 W	15.0 VDC	4.3 A	ECS65US15
65 W	18.5 VDC	3.4 A	ECS65US18
65 W	24.0 VDC	2.7 A	ECS65US24
65 W	28.0 VDC	2.3 A	ECS65US28
65 W	48.0 VDC	1.4 A	ECS65US48

Notes

1. For Class B radiated emissions models, add suffix -B to model number. For covered versions, add suffix '-C' to model number or order part no. ECM40/60 COVER for standalone cover. Derate output power by 20% with cover. The cover is not suitable for Class II installations.

Mechanical Details

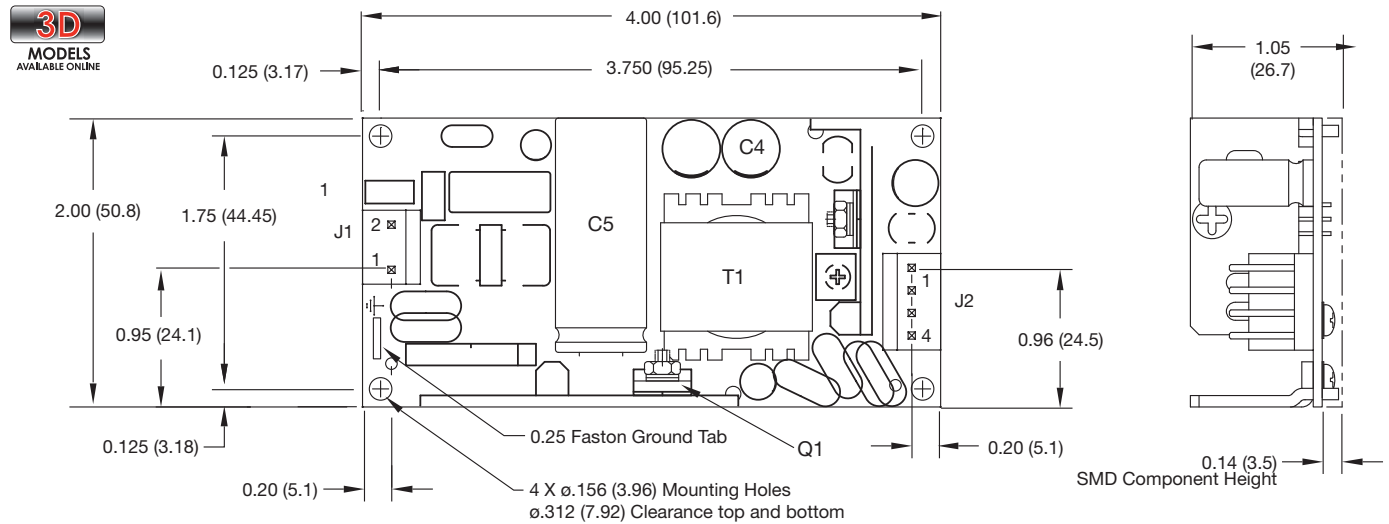

Input Connector J1 Molex PN 09-65-2038	
Pin 1	Line
Pin 2	Neutral
0.25" Faston	Earth

Output Connector J2 Molex PN 09-65-2048	
Pin 1	+V1
Pin 2	+V1
Pin 3	RTN
Pin 4	RTN

J1 mates with Molex Housing PN 09-50-1031, J2 mates with Molex Housing PN 09-50-1041 and both with Molex Series 5194 Crimp Terminals

Notes

- 1. All dimensions in inches (mm). Tolerance .xx = ±0.02 (0.50); .xxx = ±0.01 (0.25)
- 2. Weight: 0.386 lbs (175 g)

Derating Curve - ECS65 Models

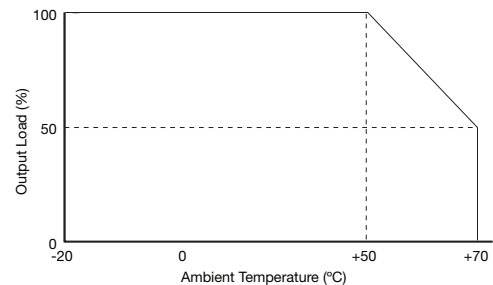
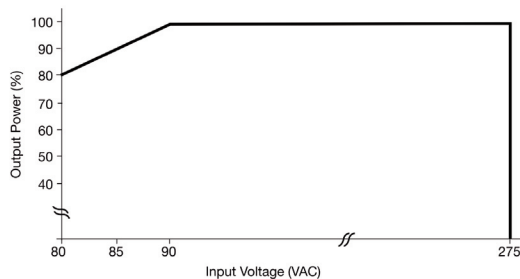

Output Power		Output Voltage	Output Current	Model Number ⁽¹⁾
Forced Cooled (10 CFM)	Convection-cooled			
100 W	80 W	12.0 VDC	8.3 A	ECS100US12
100 W	80 W	15.0 VDC	6.7 A	ECS100US15
100 W	80 W	18.0 VDC	5.5 A	ECS100US18
100 W	80 W	24.0 VDC	4.2 A	ECS100US24
100 W	80 W	28.0 VDC	3.6 A	ECS100US28
100 W	80 W	48.0 VDC	2.1 A	ECS100US48

Notes

1. For Class B radiated emissions models, add suffix -B to model number. For covered versions, add suffix '-C' to model number or order part no. ECM40/60 COVER for standalone cover. Derate output power by 20% with cover. The cover is not suitable for Class II installations. '-C' not available for '-B' models.

Mechanical Details

3D MODELS AVAILABLE ONLINE

4.00 (101.6)
3.750 (95.25)
1.25 (31.8)
0.125 (3.18)
2.00 +0.06/-0.00 (50.8 +1.5/-0.00)
1.750 (44.45)
1.00 (25.4)
0.125 (3.18)
0.20 (5.1)
0.25 Faston Ground Tab
4 X ø.156 (3.96) Mounting Holes ø.312 (7.92) Clearance top and bottom
0.20 (5.1)
Voltage Adj.
J1
C4
C5
T1
J2
1.01 (25.7)
0.14 (3.5) SMD Component Height

Output Connector J2
Molex PN 09-65-2048

Pin 1	+V1
Pin 2	+V1
Pin 3	RTN
Pin 4	RTN

Input Connector J1
Molex PN 09-65-2038

Pin 1	Line
Pin 2	Neutral
0.25" Faston	Earth

J1 mates with Molex Housing PN 09-50-1031, J2 mates with Molex Housing PN 09-50-1041 and both with Molex Series 5194 Crimp Terminals

Notes

- All dimensions in inches (mm). Tolerance .xx = ±0.02 (0.50); .xxx = ±0.01 (0.25)
- Weight: 0.386 lbs (175 g)

'-B' Model

4.50 (114.3)
3.75 (95.25)
1.25 (31.8)
0.37 (9.52)
2.00 +0.06/-0.00 (50.8 +1.5/-0.00)
1.75 (44.45)
1.00 (25.4)
0.125 (3.18)
0.20 (5.1)
0.20 (5.1)
4 X ø.156 (3.96) Mounting Holes ø.312 (7.92) Clearance top and bottom
0.25 Faston Ground Tab
J1
J2
1.01 (25.7)
0.14 (3.5) SMD Component Height

Derating Curve - ECS100 Models

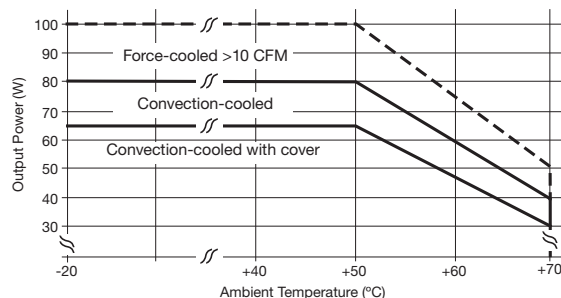
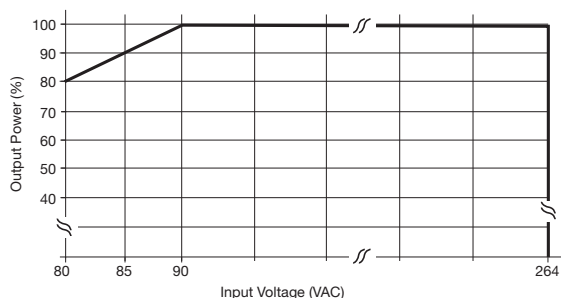

Models and Ratings

Output Power		Output Voltage	Output Current	Model Number ⁽¹⁾
Forced Cooled (10 CFM)	Convection-cooled			
130 W	100 W	12.0 VDC	10.9 A	ECS130US12
130 W	100 W	15.0 VDC	8.7 A	ECS130US15
130 W	100 W	18.0 VDC	7.3 A	ECS130US18
130 W	100 W	24.0 VDC	5.4 A	ECS130US24
130 W	100 W	28.0 VDC	4.7 A	ECS130US28
130 W	100 W	48.0 VDC	2.7 A	ECS130US48

Notes

1. For covered versions, add suffix '-C' to model number or order part no. ECM40/60 COVER for standalone cover, see derating curve. The cover is not suitable for Class II installations. '-C'.

Mechanical Details

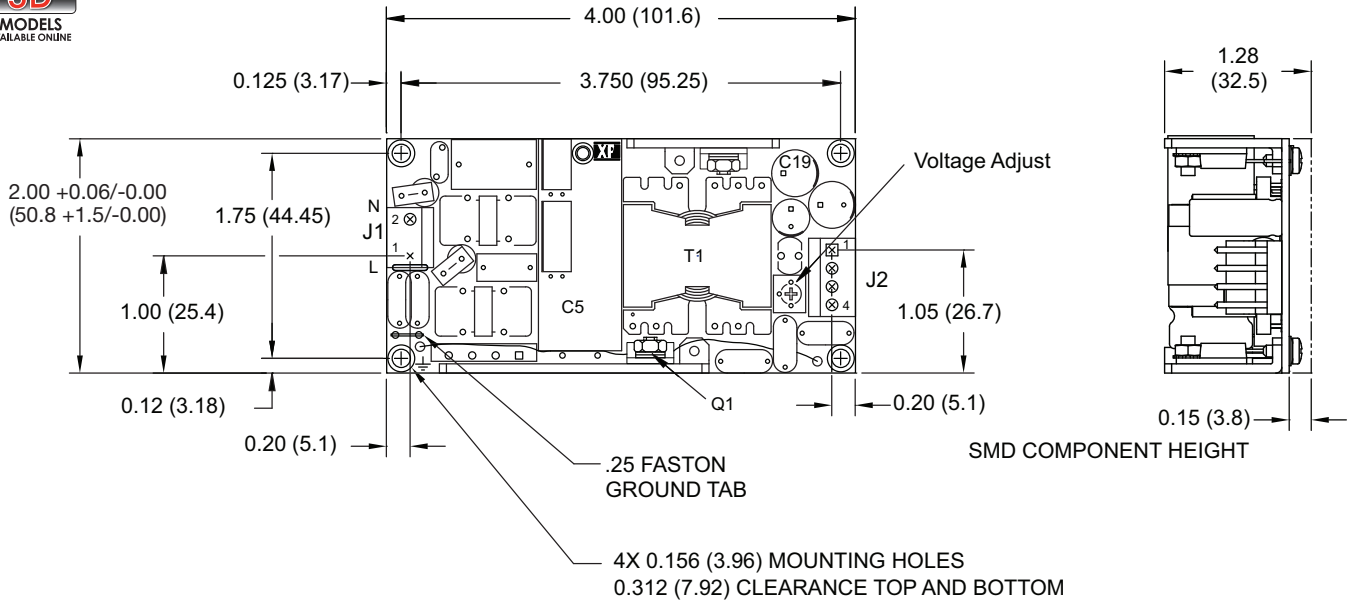

Input Connector J1 Molex PN 09-65-2038	
Pin 1	Line
Pin 2	Neutral
0.25" Faston	Earth

Notes

- All dimensions in inches (mm). Tolerance .xx = ±0.02 (0.50); .xxx = ±0.01 (0.25)
- Weight: 0.386 lbs (175 g)

Output Connector J2 Molex PN 09-65-2048	
Pin 1	+V1
Pin 2	+V1
Pin 3	RTN
Pin 4	RTN

J1 mates with Molex Housing PN 09-50-1031, J2 mates with Molex Housing PN 09-50-1041 and both with Molex Series 5194 Crimp Terminals

Derating Curve - ECS130 Models

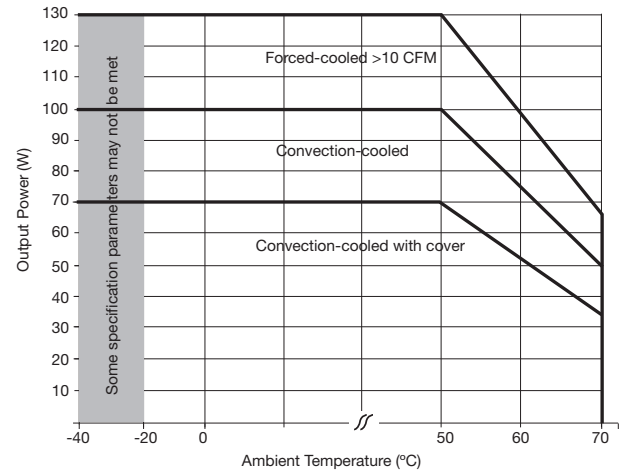
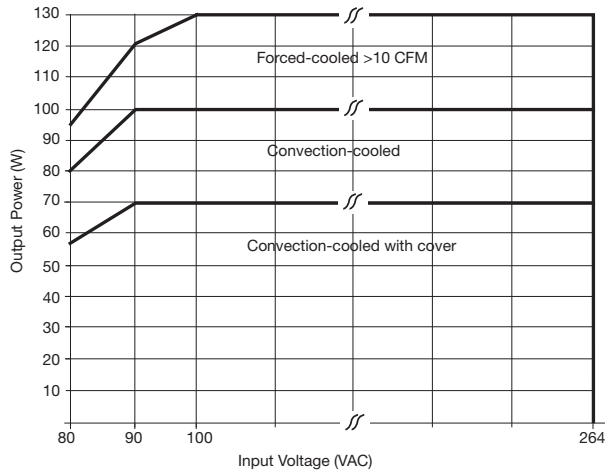

Covered Version (not available for ECS100-B Models)

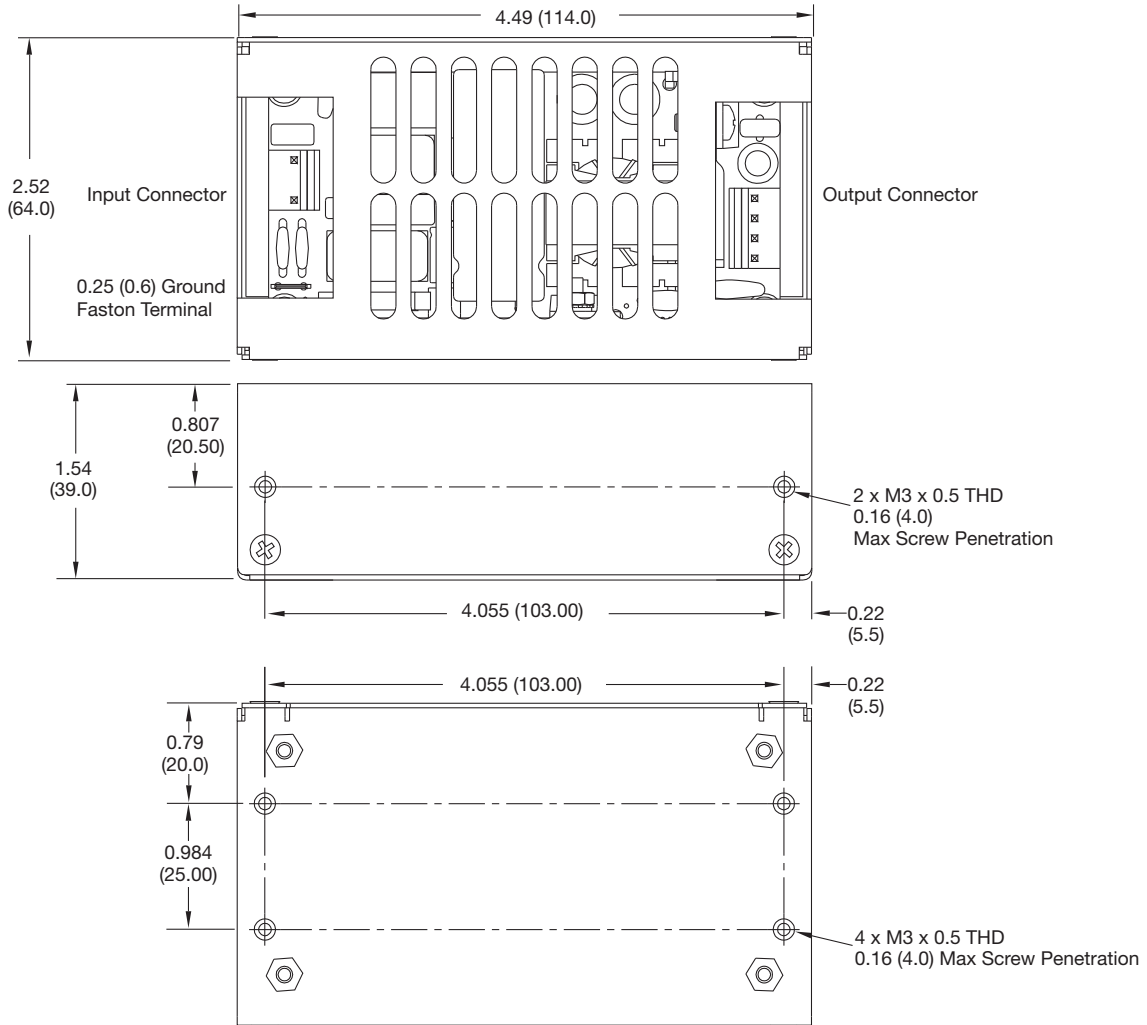

Notes

- All dimensions in inches (mm).
Tolerance .xx = ±0.02 (0.50); .xxx = ±0.01 (0.25)
- Weight: 0.8 lbs (360 g)

Thermal Considerations - All Models

In order to ensure safe operation of the PSU in the most adverse conditions permitted in the end-use equipment, the temperature of the components listed in the table below must not be exceeded. See mechanical drawing for component locations. Temperature should be monitored using K type thermocouples placed on the hottest part of the component (out of any direct air flow).

Temperature Measurements (Ambient ≤ 50 °C)	
Component	Max Temperature °C
T1	110 °C
C5	100 °C
C4/C19	100 °C
Q1	110 °C