



SF3001PT THRU SF3006PT

30.0 AMPS. Glass Passivated Super Fast Rectifiers



Voltage Range
50 to 400 Volts
Current
30.0 Amperes

Features

- ✧ Dual rectifier construction, positive center-tap
- ✧ Plastic package has Underwriters Laboratory Flammability Classifications 94V-0
- ✧ Glass passivated chip junctions
- ✧ Superfast recovery time, high voltage
- ✧ Low forward voltage, high current capability
- ✧ Low thermal resistance
- ✧ Low power loss, high efficiency
- ✧ High temperature soldering guaranteed:
260°C / 10 seconds, 0.16" (4.06mm) lead lengths at 5 lbs., (2.3kg) tension

Mechanical Data

- ✧ Cases: JEDEC TO-3P/TO-247AD molded plastic
- ✧ Terminals: Leads solderable per MIL-STD-750, Method 2026
- ✧ Polarity: As marked
- ✧ Mounting position: Any
- ✧ Weight: 0.2 ounce, 5.6 grams

TO-3P/TO-247AD

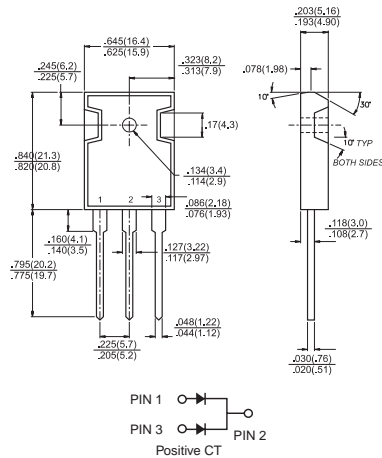

Dimensions in inches and (millimeters)

Maximum Ratings and Electrical Characteristics

Rating at 25°C ambient temperature unless otherwise specified.
Single phase, half wave, 60 Hz, resistive or inductive load.
For capacitive load, derate current by 20%

TYPE NUMBER	Symbol	SF 3001PT	SF 3002PT	SF 3003PT	SF 3004PT	SF 3005PT	SF 3006PT	Units
Maximum Recurrent Peak Reverse Voltage	V_{RRM}	50	100	150	200	300	400	V
Maximum RMS Voltage	V_{RMS}	35	70	105	140	210	280	V
Maximum DC Blocking Voltage	V_{DC}	50	100	150	200	300	400	V
Maximum Average Forward Rectified Current at $T_c=100^\circ\text{C}$	$I_{(AV)}$	30						A
Peak Forward Surge Current, 8.3 ms Single Half Sine-wave Superimposed on Rated Load (JEDEC method)	I_{FSM}	300						A
Maximum Instantaneous Forward Voltage @15.0A	V_F	0.95				1.3		V
Maximum D.C. Reverse Current @ $T_c=25^\circ\text{C}$ at Rated DC Blocking Voltage @ $T_c=100^\circ\text{C}$	I_R	10.0				500		μA
Maximum Reverse Recovery Time(Note 2) $T_J=25^\circ\text{C}$	T_{rr}	35						nS
Typical Junction Capacitance (Note 1)	C_j	175.0						pF
Typical Thermal Resistance (Note 3)	$R_{\theta JC}$	2.5						$^\circ\text{C}/\text{W}$
Operating Junction Temperature Range	T_J	-55 to +150						$^\circ\text{C}$
Storage Temperature Range	T_{STG}	-55 to +150						$^\circ\text{C}$

- Notes: 1. Measured at 1 MHz and Applied Reverse Voltage of 4.0V D.C.
2. Reverse Recovery Test Conditions: $I_F=0.5\text{A}$, $I_R=1.0\text{A}$, Recover to 0.25A.
3. Mounted on 4" x 6" x 0.25" Al-Plate.

RATINGS AND CHARACTERISTIC CURVES (SF3001PT THRU SF3006PT)

FIG. 1- REVERSE RECOVERY TIME CHARACTERISTIC AND TEST CIRCUIT DIAGRAM

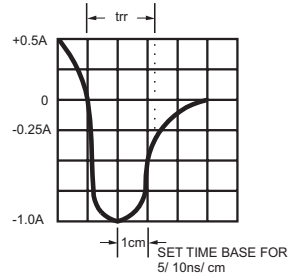
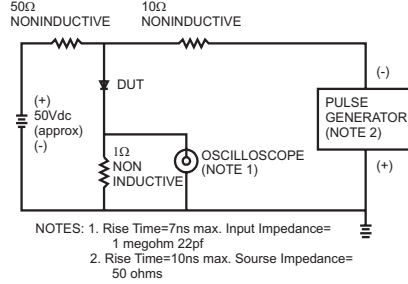

FIG.2- MAXIMUM FORWARD CURRENT DERATING CURVE

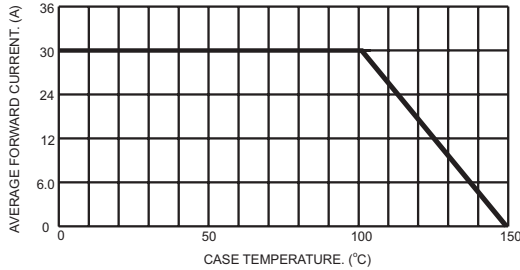

FIG.4- TYPICAL REVERSE CHARACTERISTICS PER LEG

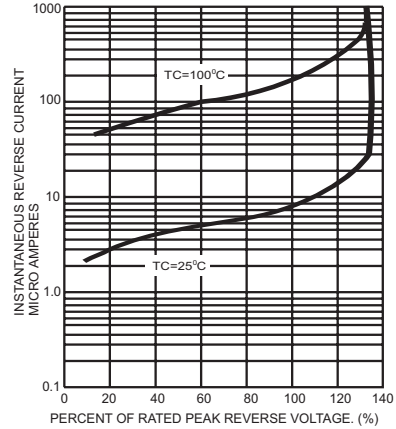

FIG.3- MAXIMUM NON-REPETITIVE FORWARD SURGE CURRENT PER LEG

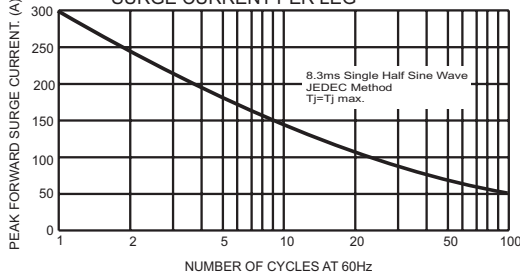

FIG.6- TYPICAL INSTANTANEOUS FORWARD CHARACTERISTICS PER LEG

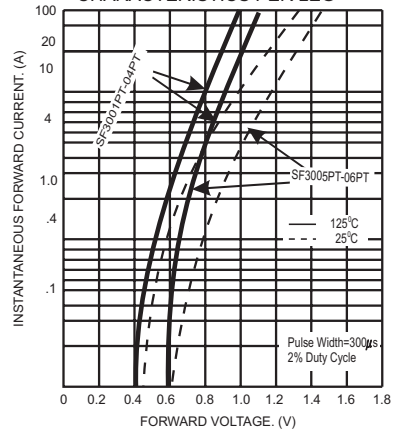

FIG.5- TYPICAL JUNCTION CAPACITANCE PER LEG

