

$$I_{F(AV)} = 3.0\text{Amp}$$

$$V_R = 40\text{V}$$

Major Ratings and Characteristics

Characteristics	Value	Units
$I_{F(AV)}$ Rectangular waveform	3.0	A
V_{RRM}	40	V
I_{FSM} @ $t_p=5\mu\text{s}$ sine	2000	A
V_F @3.0Apk, $T_J=125^\circ\text{C}$	0.43	V
T_J range	- 55 to 150	$^\circ\text{C}$

Description/ Features

The 30BQ040PbF surface-mount Schottky rectifier has been designed for applications requiring low forward drop and small foot prints on PC boards. Typical applications are in disk drives, switching power supplies, converters, free-wheeling diodes, battery charging, and reverse battery protection.

- Small foot print, surface mountable
- Very low forward voltage drop
- High frequency operation
- Guard ring for enhanced ruggedness and long term reliability
- Lead-Free ("PbF" suffix)

Case Styles

30BQ040PbF



SMC



Voltage Ratings

Part number	30BQ040PbF
V_R Max. DC Reverse Voltage (V)	40
V_{RRM} Max. Working Peak Reverse Voltage (V)	

Absolute Maximum Ratings

Parameters	30BQ	Units	Conditions
$I_{F(AV)}$ Max. Average Forward Current	3.0	A	50% duty cycle @ $T_L = 118^\circ\text{C}$, rectangular wave form
	4.0		50% duty cycle @ $T_L = 110^\circ\text{C}$, rectangular wave form
I_{FSM} Max. Peak One Cycle Non-Repetitive Surge Current	2000	A	5 μs Sine or 3 μs Rect. pulse
	110		10ms Sine or 6ms Rect. pulse
E_{AS} Non Repetitive Avalanche Energy	6.0	mJ	$T_J = 25^\circ\text{C}$, $I_{AS} = 1.0\text{A}$, $L = 12\text{mH}$
I_{AR} Repetitive Avalanche Current	1.0	A	Current decaying linearly to zero in 1 μsec Frequency limited by T_J max. $V_a = 1.5 \times V_r$ typical

Electrical Specifications

Parameters	30BQ	Units	Conditions
V_{FM} Max. Forward Voltage Drop (1)	0.53	V	@ 3A
	0.68	V	@ 6A
	0.43	V	@ 3A
	0.57	V	@ 6A
I_{RM} Max. Reverse Leakage Current (1)	0.5	mA	$T_J = 25^\circ\text{C}$
	30	mA	$T_J = 125^\circ\text{C}$
C_T Max. Junction Capacitance	230	pF	$V_R = 5V_{DC}$ (test signal range 100KHz to 1Mhz) 25°C
L_S Typical Series Inductance	3.0	nH	Measured lead to lead 5mm from package body
dv/dt Max. Voltage Rate of Change	10000	V/ μs	(Rated V_R)

(1) Pulse Width < 300 μs , Duty Cycle < 2%

Thermal-Mechanical Specifications

Parameters	30BQ	Units	Conditions
T_J Max. Junction Temperature Range (*)	-55 to 150	$^\circ\text{C}$	
T_{stg} Max. Storage Temperature Range	-55 to 150	$^\circ\text{C}$	
R_{thJL} Max. Thermal Resistance Junction to Lead (**)	12	$^\circ\text{C}/\text{W}$	DC operation
R_{thJA} Max. Thermal Resistance Junction to Ambient	46	$^\circ\text{C}/\text{W}$	DC operation
wt Approximate Weight	0.24 (0.008)	g (oz.)	
Case Style	SMC		Similar to DO-214AB
Device Marking	IR3F		

(*) $\frac{dP_{tot}}{dT_J} < \frac{1}{R_{th(j-a)}}$ thermal runaway condition for a diode on its own heatsink

(**) Mounted 1 inch square PCB

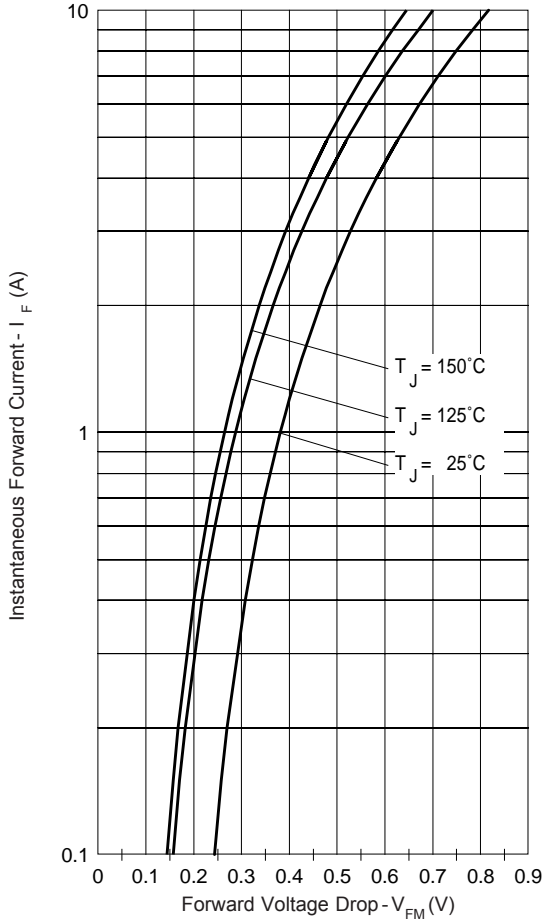

Fig. 1 - Max. Forward Voltage Drop Characteristics (Per Leg)

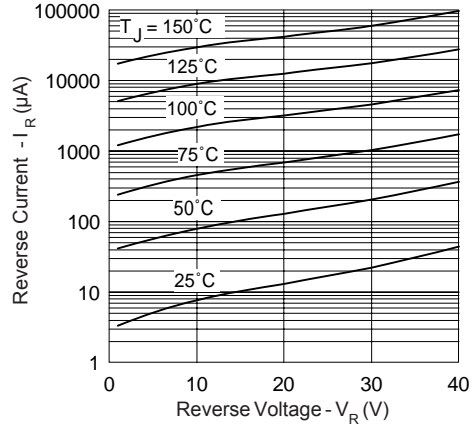

Fig. 2 - Typical Values Of Reverse Current Vs. Reverse Voltage (Per Leg)

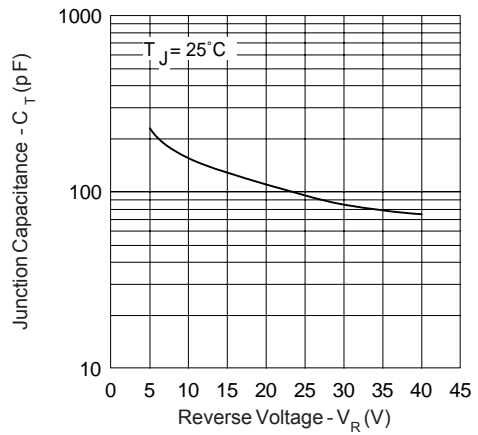

Fig. 3 - Typical Junction Capacitance Vs. Reverse Voltage (Per Leg)

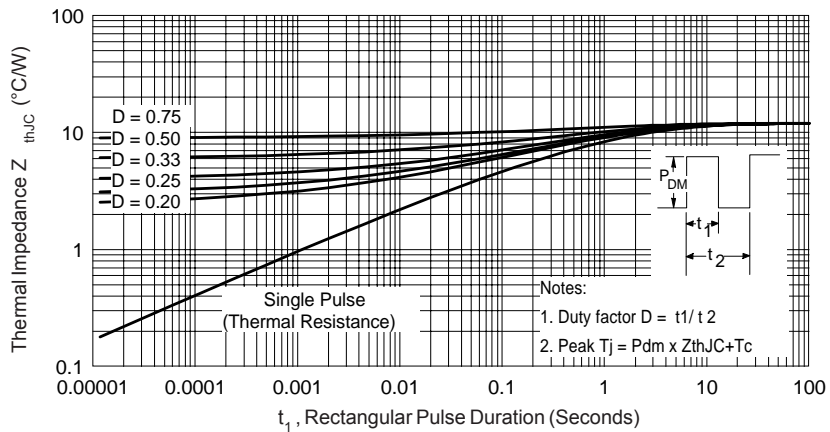

Fig. 4 - Max. Thermal Impedance Z_{thJC} Characteristics (Per Leg)

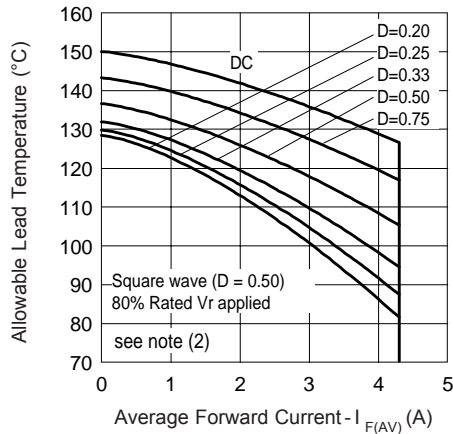

Fig. 4 - Maximum Average Forward Current Vs. Allowable Lead Temperature

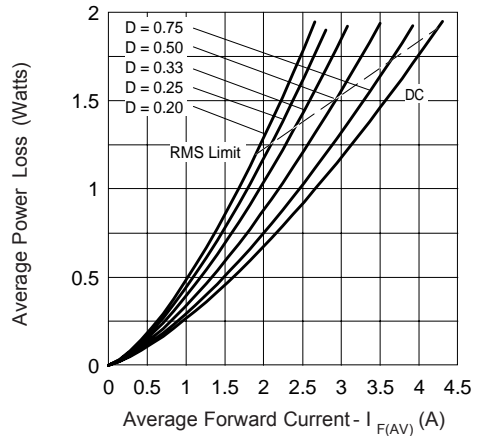

Fig. 5 - Maximum Average Forward Dissipation Vs. Average Forward Current

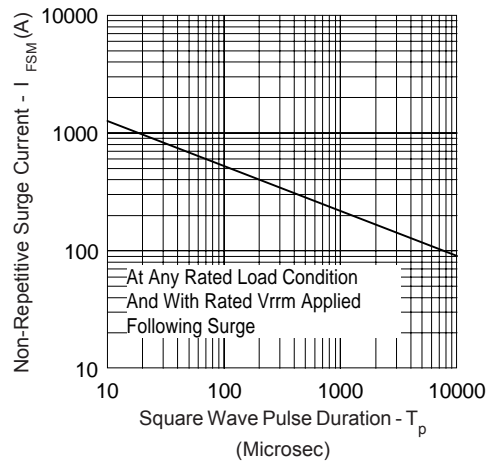

Fig. 6 - Maximum Peak Surge Forward Current Vs. Pulse Duration

(2) Formula used: $T_c = T_j - (Pd + Pd_{REV}) \times R_{thJC}$;

Pd = Forward Power Loss = $I_{F(AV)} \times V_{FM} @ (I_{F(AV)} / D)$ (see Fig. 6);

Pd_{REV} = Inverse Power Loss = $V_{R1} \times I_R (1 - D)$; $I_R @ V_{R1} = 80\%$ rated V_R

Outline Table

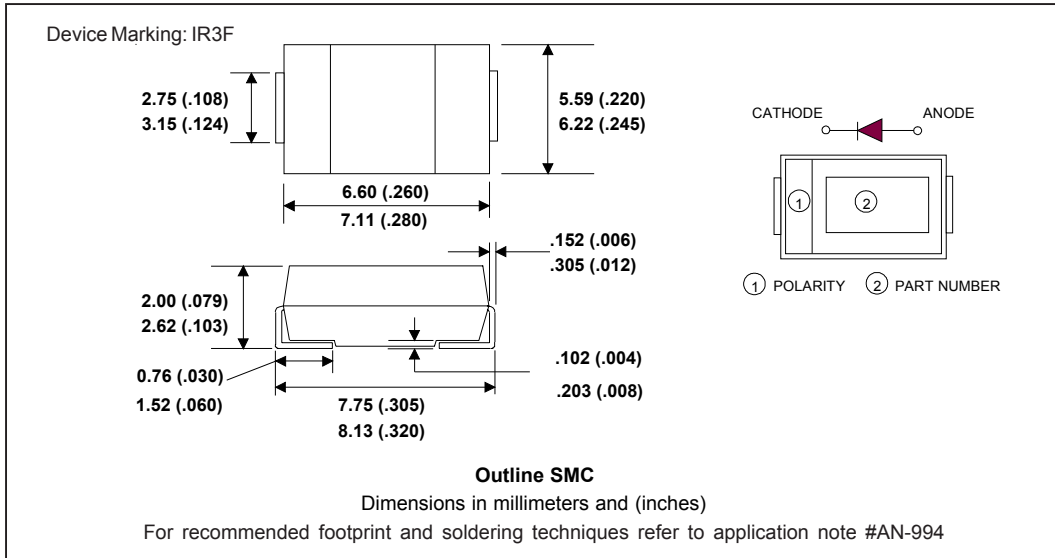

Marking & Identification

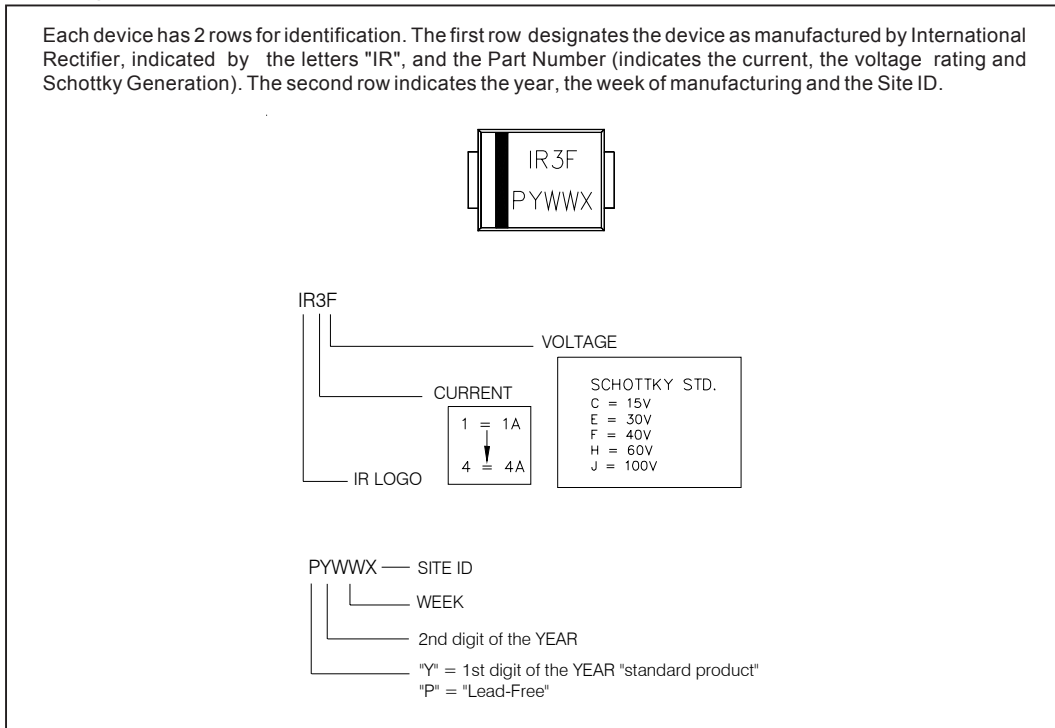

Tape & Reel Information

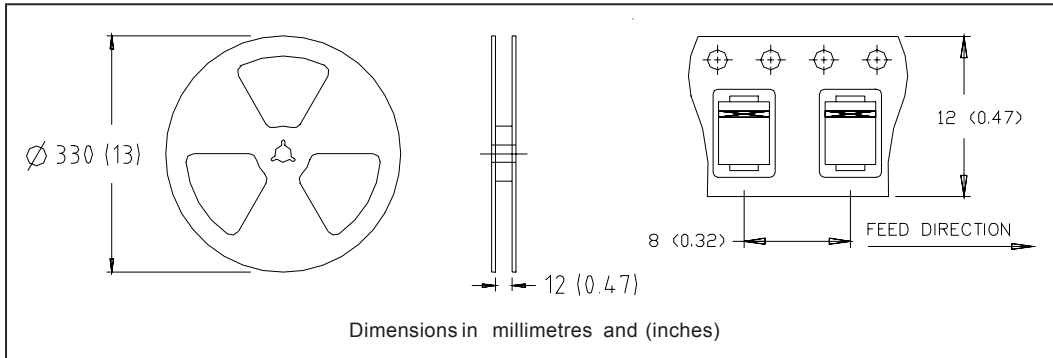

Ordering Information Table

Device Code	30	B	Q	040	TR	PbF
	1	2	3	4	5	6
1	-	Current Rating				
2	-	B = Single Lead Diode				
3	-	Q = Schottky Q Series				
4	-	Voltage Rating (040 = 40V)				
5	-	• none = Box (1000 pieces)				
		• TR = Tape & Reel (3000 pieces)				
6	-	• none = Standard Production				
		• PbF = Lead-Free				

Data and specifications subject to change without notice.
This product has been designed and qualified for Industrial Level and Lead-Free.
Qualification Standards can be found on IR's Web site.