

Piezosignalgeber RMP-28SW03-DT Art.-Nr. 185525

Specification:

TYPE	UNIT	RMP-28SW03-DT
• Min. Sound Output at 30cm	dB	85
Rated Voltage	VDC	3
Operating Voltage	VDC	2~5
Resonant Frequency	Hz	2800±100
• Max. Current Consumption	mA	10
Tone		Single
Operating Temperature	°C	-20~+70
Storage Temperature	°C	-30~+70
Weight	g	10

- Value applying at rated voltage

Dimensions:

(Unit: mm)

Wire: UL 1007 #28

AWG 28

LEAD TYPE

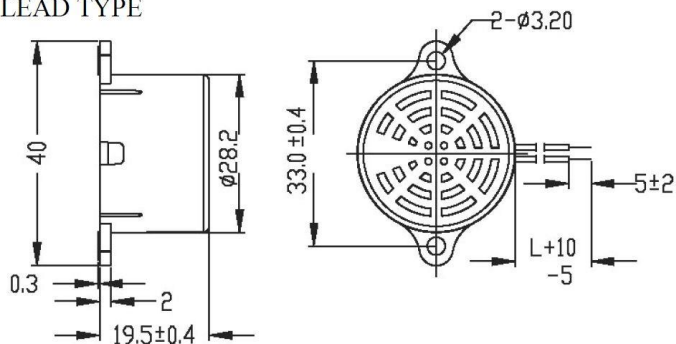

Frequency response:

