

EXTRUSION

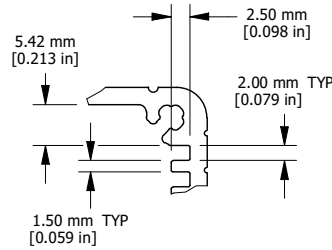

DETAIL A

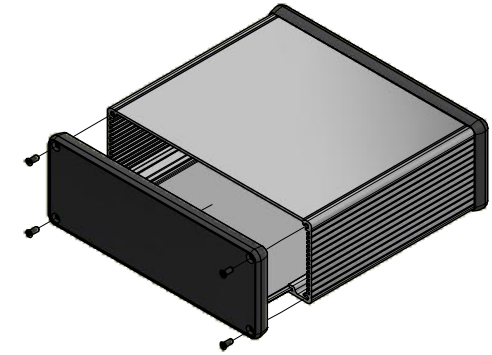

EXPLODED ISOMETRIC VIEW

EXTRUSION DESIGNED FOR 186MM WIDE PC BOARD

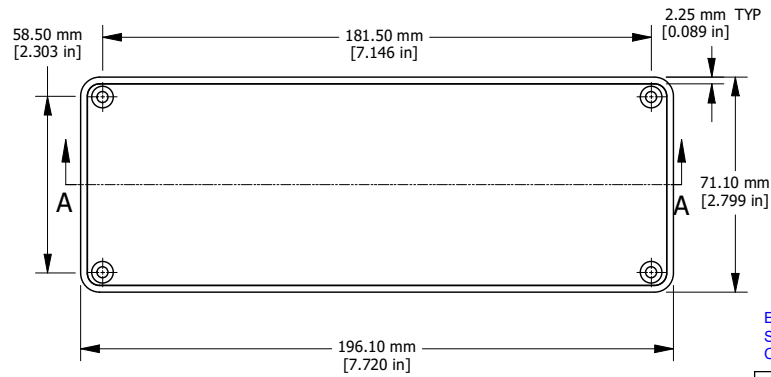
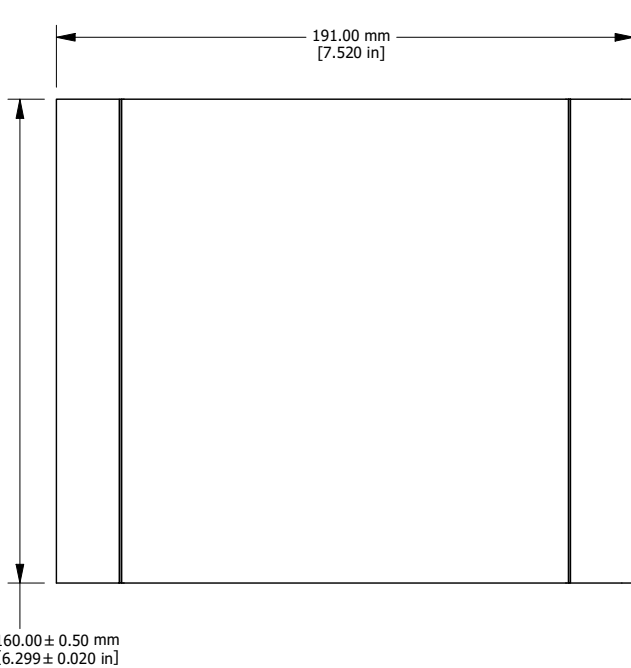

CLOSED BEZEL

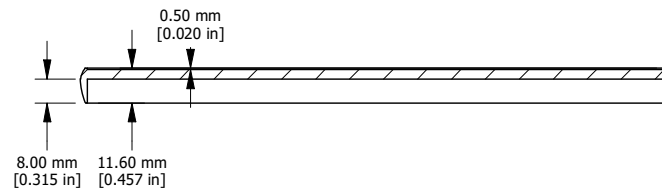

SECTION A-A

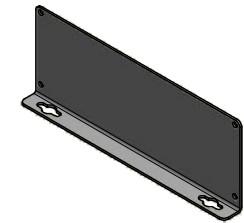

OPTIONAL FLANGED  
END PANELS 1455UF

Enclosures can be Factory Modified ( Milling, Drilling, Printing etc. )  
Solid models of this enclosure available in STEP or IGES.  
Contact Factory [mjm@hammondmfg.com](mailto:mjm@hammondmfg.com)

NOTE	
Purchased assembly includes box, plastic bezels, #6 Taptight screws and self adhesive rubber feet.	
Box made from Extruded Aluminum 6063.	
Bezels made with ABS.	
1455U1602	
PART NUMBERS	
Clear Anodized	1455U1602
Black Anodized	1455U1602BK
ACCESSORIES	
See website for accessories.	



HAMMOND  
MANUFACTURING™

1455U1602

[www.hammondmfg.com](http://www.hammondmfg.com)