

CUERPO

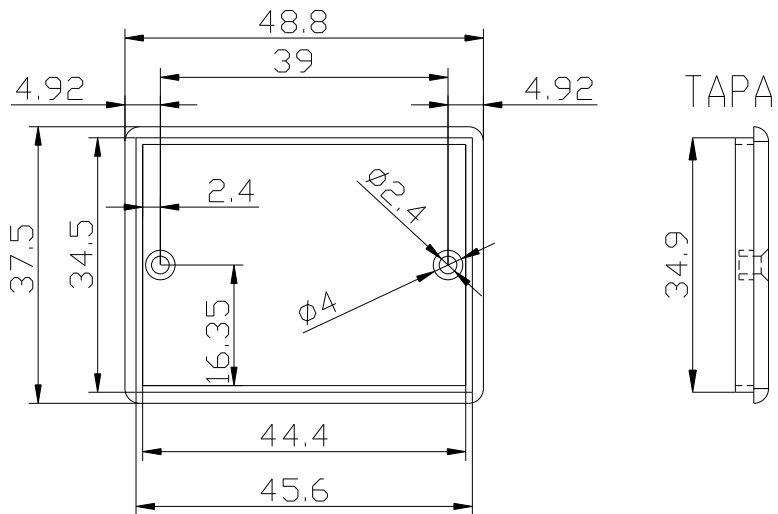

TAPA

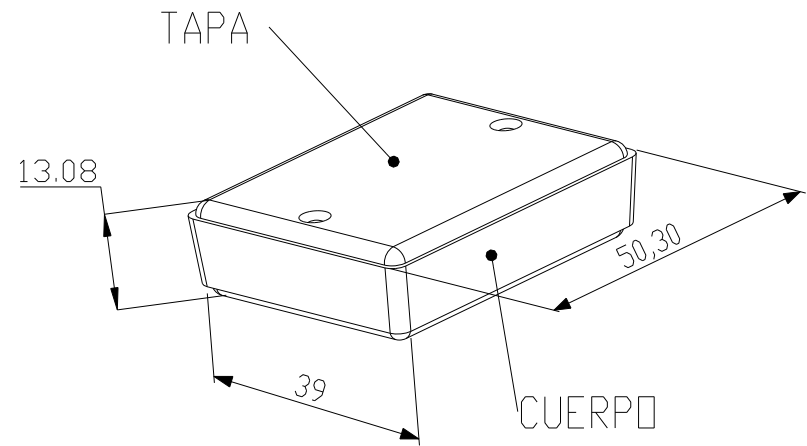
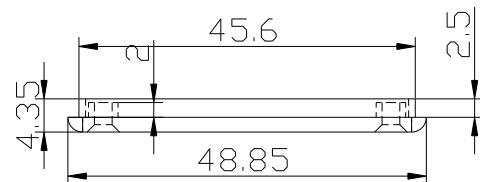
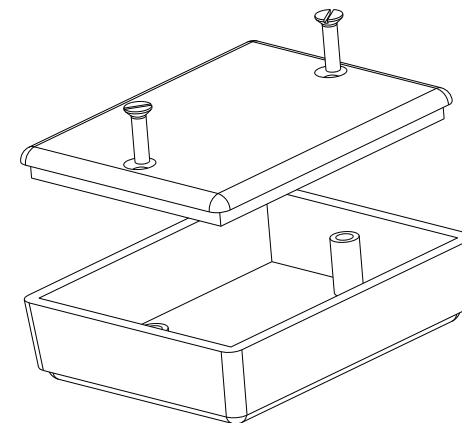

2 Tornillos 2.9x6.5 DIN 7981
2 Screws 2.9x6.5 DIN 7981

		Proprietary and confidential of Supertronic		
Plano		Formato DIN A4		
Dibujado	D.R.	Fecha 2007	Peso (gr) 10.5	Dimensiones 50x39x14
Revisado	J.R.	Fecha 2008	Escala 1/1	Material ABS
		Código	Dimensions are in millimeters Tolerance ±0.2mm	
Referencia cliente		Modelo PP67		