

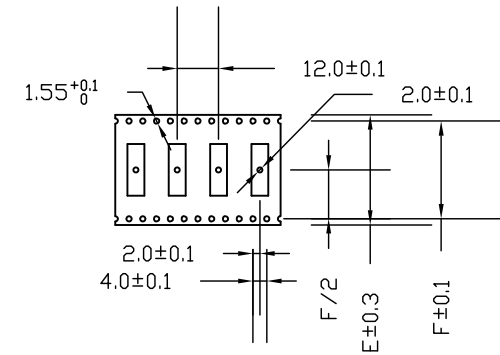

RoHS Compliant
2002/95/EC

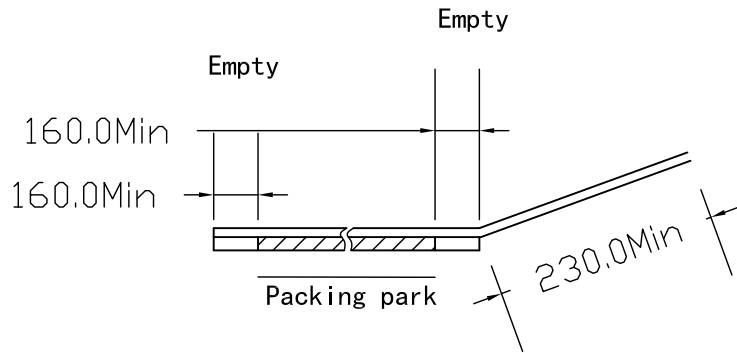

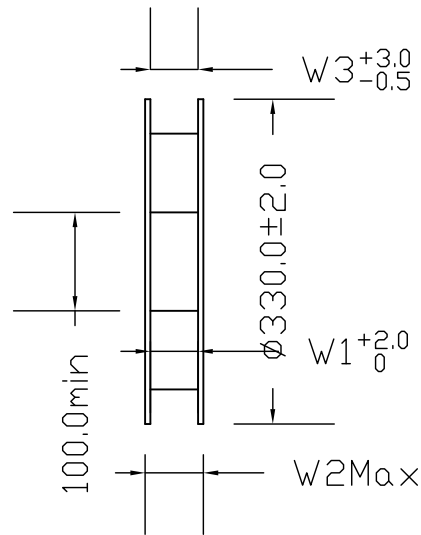
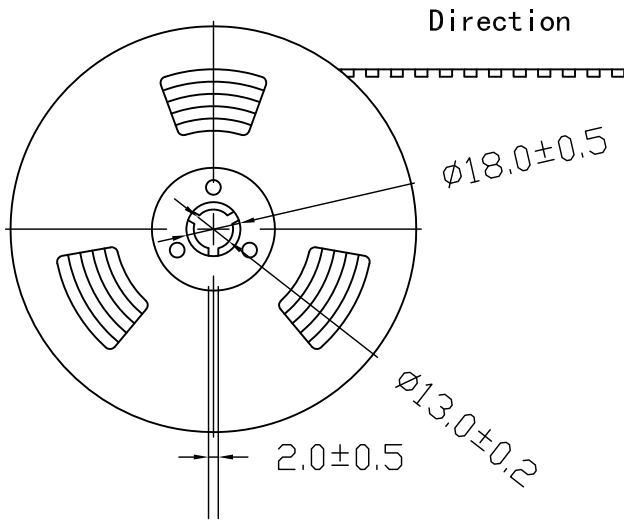
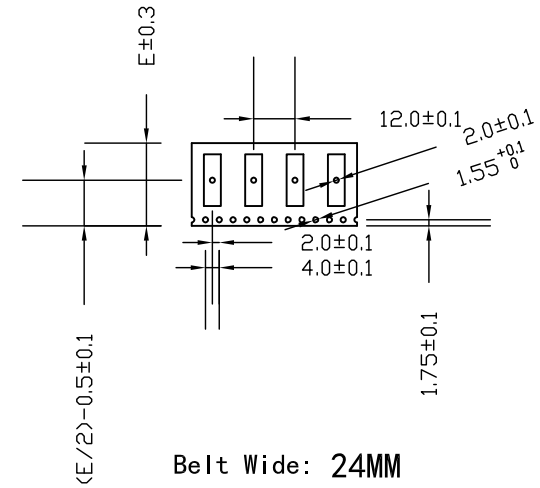

Belt Wide: 32, 44, 56MM



Belt Wide: 24MM

Pins	Dimensions				
	E	F	W1	W2	W3
4~9	24.0		24.5	30.5	24.5
10~13	32.0	28.4	32.5	38.5	32.5
14~27	44.0	40.4	44.5	50.5	44.5
28~36	56.0	52.4	56.5	62.5	56.5

Belt Base:		PS ; Black		Drawing Number:			 ElectronAix ElectronAix GmbH & Co. KG
Belt Cover:		TPE ; Transparent		Z11-XX			
Quantity :		1,500 Pcs/Reel		Ref. Number: ZIF 1,0mm Upper Contact			
Date	Modification	Contents	Revise Doc. Num.	Checked	Approval	Tolerance	Unit : MM
						Dimensions	 Scale: 1:1 Page: 2/2
						X. =0.3	
						X.X =0.25	
						X.XX=0.1	0.3°
R00-2015-01-20							

Specification Z11-xx Series
ZIF FFC/FPC Connector 1,0mm Pitch Upper Contact H3,0mm Slider

1 Scope

This Specification covers the construction and characteristics of 0,5mm Pitch FFC and FPC (Flat Flexible Cable and Flat PCB Cable) of Z11-xx-ZIF Connector Series. The part shall satisfy the following performance

2 Material and Plating

Item	Material	Plating	Remark
Terminal	Phosphor Bronze C5191R-H	Ni \geq 0,5 μ m SN \geq 1,0 μ m	ROHS REACH
Solder Pad	Phosphor Bronze C5191R-H	Ni \geq 0,5 μ m SN \geq 1,0 μ m	ROHS REACH
Base/Housing	PA6T	Color: Nature	ROHS REACH UL94V-0
Lock	PPS	Color: Brown	ROHS REACH UL94V-0

3 Environmental

The products meet EU RoHS Directive 2011/65/eu
The products meet EU REACH Directive 1907/2006/EU

4 Technical Parameter

Item	Specification
Voltage Rating	50V AC/DC
Current rating	1,0A AC/DC
Temperature Range	-40°C ... +85°C
Voltage Withstand	500V / Min.
Contact Resistance	\leq 0,03 Ω
Insulation Resistance	\geq 500M Ω

Specification Z11-xx Series
ZIF FFC/FPC Connector 1,0mm Pitch Upper Contact H3,0mm Slider

5 Performance

5.1 Electrical Performance

Item	Requirement	Testing Method
Contact Resistance	$\leq 0,03 \Omega$ Initial	Connecting the mated connector to a closed circuit of current 10mA and max. 20mV
Insulation Resistance	$\geq 500M \Omega$	Checking the resistance between terminals & terminals with grounding. MIL-STD-202, Method 302, Condition B (500V DC \pm 10%)
Dielectric Strength	Connector must withstand the test of 200V AC for 1minute and current leakage must be 0.5mA maximum.	Checking the dielectric strength between terminals & terminals with grounding. MIL-STD-202, Method 301.

5.2 Mechanical Performance

Item	Requirement	Testing Method
FFC/FPC Retention Force	$\geq 0,4N/Pcs$ initial $\geq 0,3N/Pcs$ 10 Times	Withdraw FPC from the locked connector with a speed of 25 ± 3 mm/minute
Contact Retention Force	$\geq 0,3N/Pcs$	pull out the terminal from connector base with a speed of 25 ± 3 mm/minute.
Solderability	Appearance of the specimen shall be inspected after the test with the assistance of a 10X magnifier. No damage such as pinholes, void or rough surface should be found.	Reflow: 2 Cycles 250°C 5 Sec. Wave: 1 Cycle 250°C 5 Sec.
Resistance to Soldering Heat	No damage	255 \pm 5°C chamber for 10 \pm 0.5Seconds

5.3 Environmental Performance

Item	Requirement	Testing Method
Temperature rise	No damage, Contact Resistance $\leq 0.03\Omega$	Temperature range from -40°C to +85°C 3 Minute per cycles. Total 5 cycles.
High temperature	No damage, Contact Resistance $\leq 0.03\Omega$	Subject product to 85 \pm 2°C for 96 hours continuously. MIL-STD-202, Method 108
Low temperature	No damage, Contact Resistance $\leq 0.03\Omega$	Subject product to -40 \pm 2°C for 96 hours continuously. MIL-STD-202, Method 108
Humidity	No Damage, Contact Resistance $\leq 0.03\Omega$ Insulation Resistance $\geq 500 M\Omega$	Temperature:40 \pm 2°C 96 hours. Relative Humidity:90-95% MIL-STD-202, Method 103
Salt Spray	Surface: No serious oxidation Contact Resistance $\leq 0.03\Omega$	5 \pm 1% salt solution 48 \pm 4 hours 35 \pm 2°C MIL-STD-202, Meth.101 Cond. B
Flammability	Material conform to UL94V-0	Vertical burning method

Specification Z11-xx Series
ZIF FFC/FPC Connector 1,0mm Pitch Upper Contact H3,0mm Slider

6 Marking, Packing, Transportation, Store

6.1 Logo

Connector had stamped production line logo: LW

6.2 Packing

Inner packing with Plastic Tube or Tape & Reel.

Outer with a carton box.

No shaking.

6.3 Transportation

Allow using any transportation, but cannot expose under rain, snow, and machinery injury.

6.4 Store

Finished goods should be kept in a well store environment.

Temperature: $-10^{\circ}\text{C} \sim +40^{\circ}\text{C}$; Humidity maximum 80%

No acidity, alkalinity, corrosiveness gas are allow within the store.

Storage period is 12 month, if over 12 month has to reexamine.

7 Infrared Reflow Condition

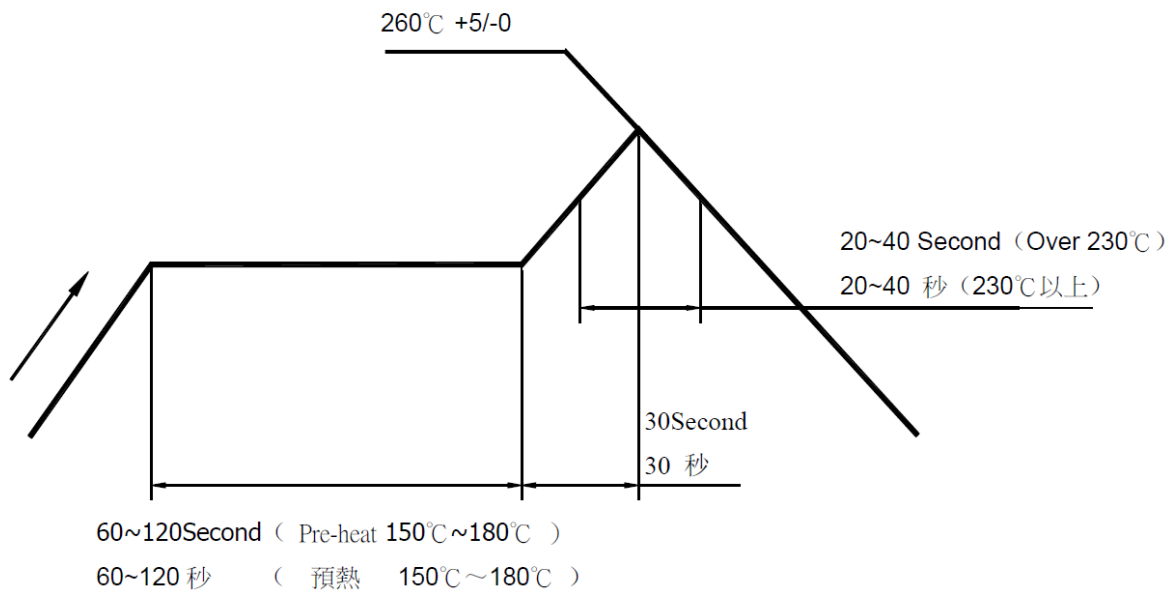

Specification Z11-xx Series
ZIF FFC/FPC Connector 1,0mm Pitch Upper Contact H3,0mm Slider

8 How to Order

Zxy-nn-CPTO

O = Option

T = Packing 1 = Reel
 2 = Tube

P = Plating 11 = Tin 1um
 24 = Au 10u“

C = Contact Type 1 = single contact
 2 = double contact

nn = No. of Positions 04 ... 80

y = mating style 1 = upper contact
 2 = lower contact
 3 = vertical Type A /
 4 = vertical Type B\
 5 = Piano- / Fliplock H1,56mm Double Contact
 6 = Piano- / Fliplock H1,96mm High Retention
 7 = Piano- / Fliplock H1,20mm Low Profile

Zx = Series Z1 = ZIF FFC / FPC 1,0mm Pitch
 Z5 = ZIF FFC / FPC 0,5mm Pitch
 Z3 = ZIF FFC / FPC 0,3mm Pitch
 Lx = LIF FFC / FPC 0,3mm Pitch