

Display Elektronik GmbH

DATA SHEET

LCD MODULE

DEM 1024768B VM-PW-N

8,0" TFT

Product Specification

Ver.:0

19.07.2018

Revise Records

Rev.	Date	Contents	Written	Approved
0	19.07.2018	Preliminary Specification	J	MH

Special Notes

Note1.	
Note2.	
Note3.	
Note4.	
Note5.	

Contents

1. General Description and Features	4
1.1 Features	4
1.2 LCD Module	4
2. Mechanical Information	4
3. Electrical Specifications	5
3.1 Absolute Max. Ratings	5
3.2 AC Timing Characteristic of the LCD	7
3.3 Back-Light Unit	13
4. Optical Characteristics	14
4.1 Optical characteristic of the LCD	14
5. I/O Terminal	16
5.1 LCD Pin Assignment	16
5.2 Back Light Unit	18
5.3 Block Diagram	19
6. Displayed Color and Input Data	20
7. Reliability Condition	21
8. Dimensional Outlines	22
9. Incoming Inspection Standards	23

1. General Description and Features

This TFT is applied to the 8 Inch XGA 1024 x RGB x 768 Dots (4:3 Aspect Ratio) supported TFT-LCD module and can display true 16.7 Million colors (8 Bit/Color).The module is designed for OA, Car TV application and other electronic products which require flat panel display of digital signal interface. This module is composed of a 8" TFT-LCD panel, a driver circuit and backlight unit. The following table described the features:

1.1 Features

- Transmissive and Backlight with 27 LEDs are available.
- LVDS Receiver 6/8 Bit Interface.
- ROHS Compliance

1.2 LCD Module

Item	Specification	Unit
Screen Size	8.0 Inches	Diagonal
Display Resolution	1024 x RGB x 768	Pixel
Active Area	162.05 x 121.54	mm
Outline Dimension	175.70 x 137.85 x 5.60	mm
Display Mode	Normally Black	--
Pixel Arrangement	R,G,B Vertical Stripe	--
Pixel Size	0.15825 x 0.15825	mm
Surface Treatment	Hard Coating	
Display Color	16.7 Million	--
Viewing Direction	Full View Angle	--
Input Interface	LVDS Receiver 6/8-Bit-Interface	--

2. Mechanical Information

Item	Min.	Typ.	Max.	Unit	Note	
Module Size	Horizontal (H)	175.40	175.70	176.00	mm	
	Vertical (V)	137.55	137.85	138.15	mm	
	Thickness (T)	5.30	5.60	5.90	mm	(1)
Weight	--	t.b.d.	--	g	--	

Note (1) Not Include Component. Refer to the Outline Dimension Drawing as attached.

3. Electrical Specifications**3.1 Absolute Max. Ratings**

3.1.1 Absolute Ratings of Environment

If the operating condition exceeds the following absolute maximum ratings, the TFT LCD module may be damaged permanently.

(Ta=25±2°C, V_{SS}=GND=0)

Item	Symbol	Min.	Max.	Unit	Note
Storage Temperature	T _{STG}	-20	60	°C	(1)(2)
Operating Temperature	T _{OPR}	-10	50	°C	(1)(2)

Note1: Background color changes slightly depending on ambient temperature. This phenomenon is reversible.

Note2: Please refer to item of RELIABILITY.

3.1.2 Electrical Absolute Maximum Ratings

3.1.2.1 TFT-LCD Module

(V_{SS}=GND=0)

Parameter	Symbol	Min.	Max.	Unit	Remark
Power Supply Voltage	V _{CC}	-0.3	5.0	V	
	AVDD	6.5	13.5	V	
	V _{GH}	-0.3	40	V	
	V _{GL}	-20	0.3	V	
	V _{GH-VGL}	-	40	V	

Note 1: The absolute maximum rating values of this product are not allowed to be exceeded at any times.

Should a module be used with any of the absolute maximum ratings exceeded, the characteristics of the module may not be recovered, or in an extreme case, the module may be permanently destroyed.

3.1.2.2 Backlight Unit

(V_{SS}=GND=0)

Parameter	Symbol	Min.	Max.	Unit	Remark
Current of Backlight Unit	I _B	--	432	mA	
Voltage of Backlight Unit	V _B	--	10.8	V	

3.1.3 DC Electrical Characteristics of the TFT LCD

(GND=AVSS=0V, Note 1)

Item	Symbol	Values			Unit	Remark
		Min.	Typ.	Max.		
Power voltage	V _{CC}	3.0	3.3	3.6	V	Note 2
	AV _{DD}	9.8	10	10.2	V	
	V _{GH}	18.6	18.9	19.2	V	
	V _{GL}	-8.1	-7.8	-7.5	V	
Input signal voltage	V _{COM}	2.6	3.6	4.6	V	Note 3
Input logic high voltage	V _{IH}	0.7V _{CC}	-	V _{CC}	V	Note 4
Input logic low voltage	V _{IL}	0	-	0.3V _{CC}	V	

Note 1: Be sure to apply V_{CC} and V_{GL} to the LCD first, and then apply V_{GH}.

Note 2: V_{CC} setting should match the signals output voltage (refer to Note 3) of customer's system board .

Note 3: Typical V_{com} is only a reference value, it must be optimized according to each LCM, please use VR and base on below application circuit.

Note 4: RESET, STBYB, SELB, L/R, U/D, CABEN0, CABEN1.

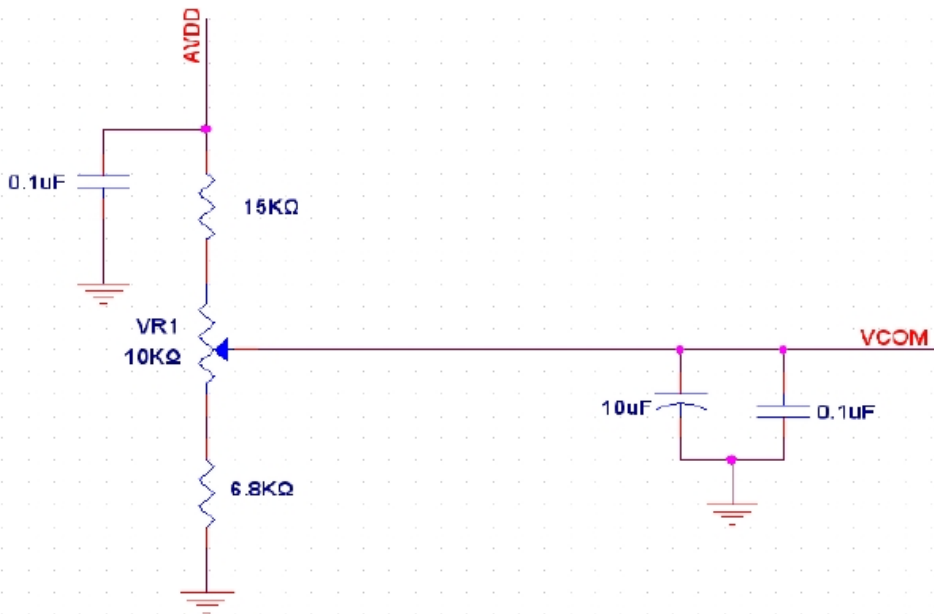

(GND=AV_{SS}=0V)

Item	Symbol	Values			Unit	Remark
		Min.	Typ.	Max.		
Current for Driver	I _{GH}	-	0.65	1.0	mA	V _{GH} =18.9V
	I _{GL}	-	0.65	1.0	mA	V _{GL} =-7.8V
	I _{CC}	-	35	60	mA	V _{CC} =3.3V
	I _{AVDD}	-	25	40	mA	AV _{DD} =10.0V

3.2 AC Timing Characteristic of the LCD

3.2.1 AC Electrical Characteristics

Parameter	Symbol	Values			Unit	Remark
		Min.	Typ.	Max.		
Clock frequency	R _{XFCLK}	20	-	71	MHz	
Input data skew margin	T _{RSKM}	500	-	-	ps	
Clock high time	T _{LVCH}	-	4/(7* R _{XFCLK})	-	ns	
Clock low time	T _{LVCL}	-	3/(7* R _{XFCLK})	-	ns	

3.2.2 Timing Characteristic
 Input Clock and Data Timing Diagram

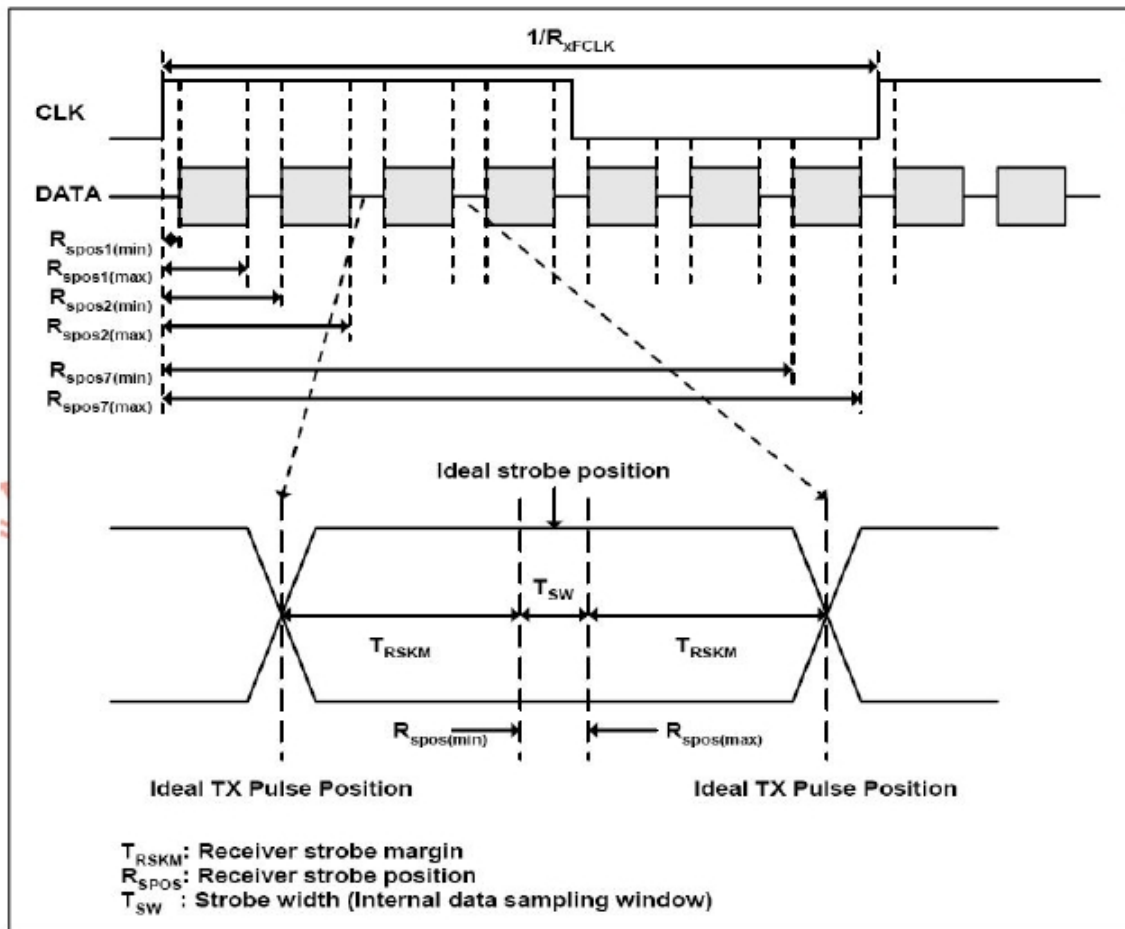

Parameter	Symbol	Values			Unit	Remark
		Min.	Typ.	Max.		
Differential input high Threshold voltage	R_{xVTH}	-	-	+0.1	V	
Differential input low Threshold voltage	R_{xVTL}	-0.1	-	-	V	
Input voltage range (singled-end)	R_{xVIN}	0	-	2.4	V	
Differential input common mode voltage	R_{xVCM}	$ V_{ID} /2$	-	$2.4- V_{ID} /2$	V	
Differential voltage	$ V_{ID} $	0.2	-	0.6	V	
Differential input leakage current	$R_{V_{xIIZ}}$	-10	-	+10	uA	

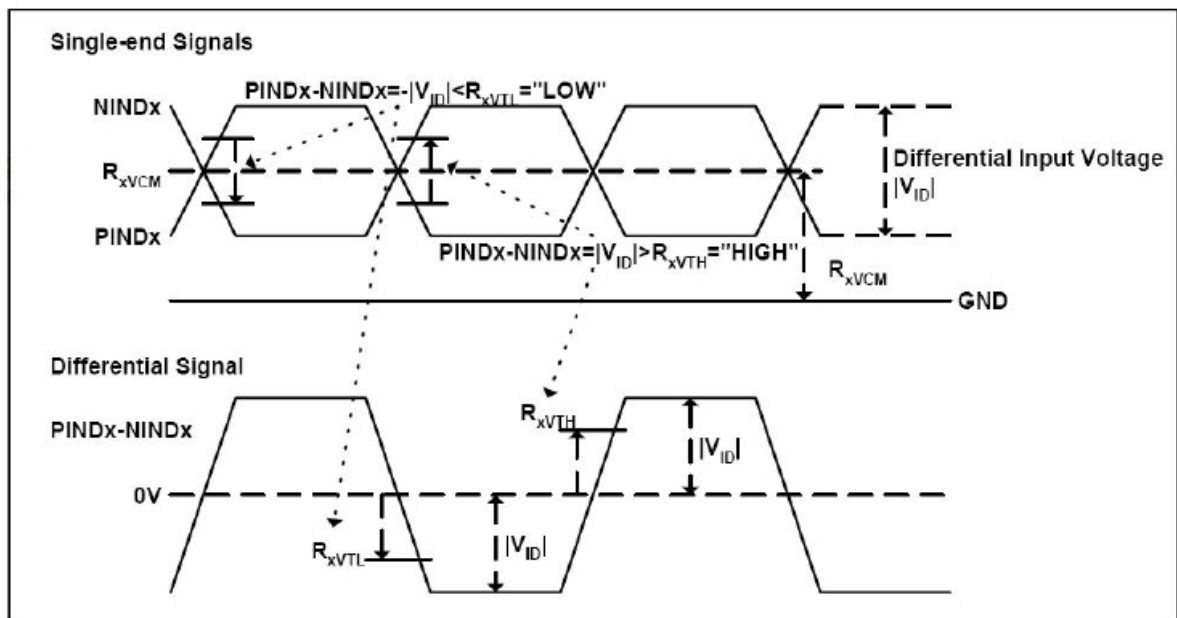

Timing:

Item	Symbol	Values			Unit	Remark
		Min.	Typ.	Max.		
Clock Frequency	fclk	52	65	71	MHz	Frame rate =TBD
Horizontal display area	thd	1024				
HS period time	th	1114	1344	1400	DCLK	
HS Blanking	thb+thfp	90	320	376	DCLK	
Vertical display area	tvd	768				
VS period time	tv	778	806	845	H	
VS Blanking	tvb+tvfp	10	38	77	H	

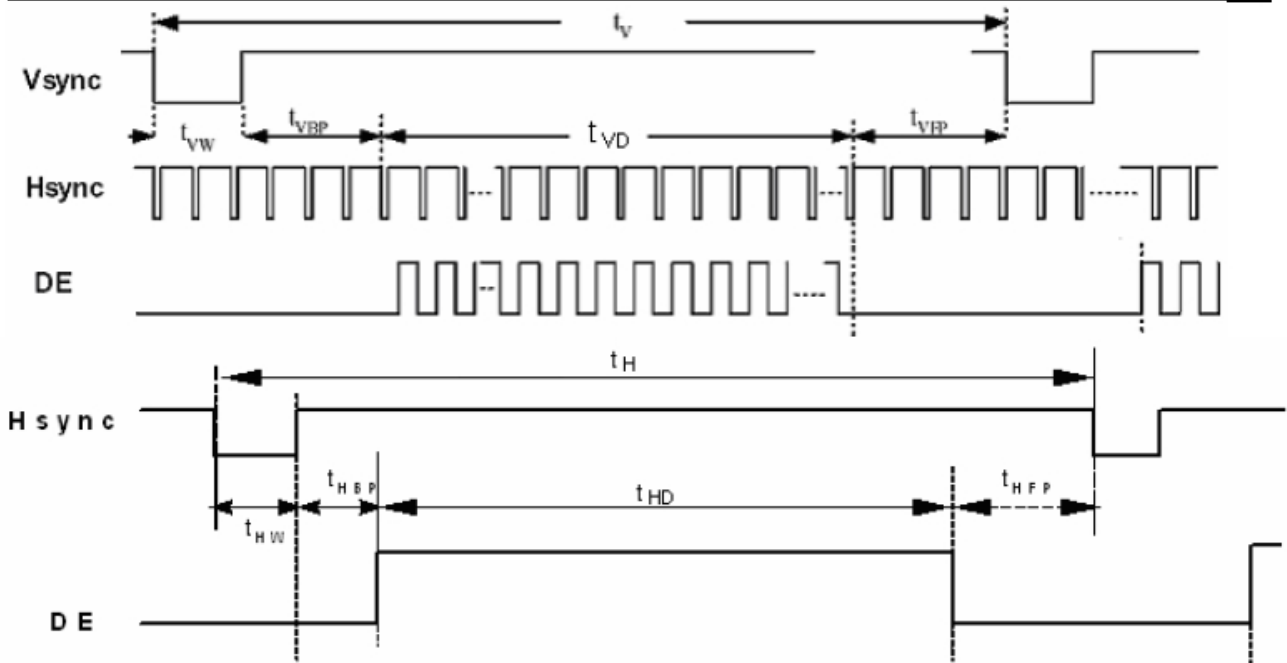

6bit LVDS input

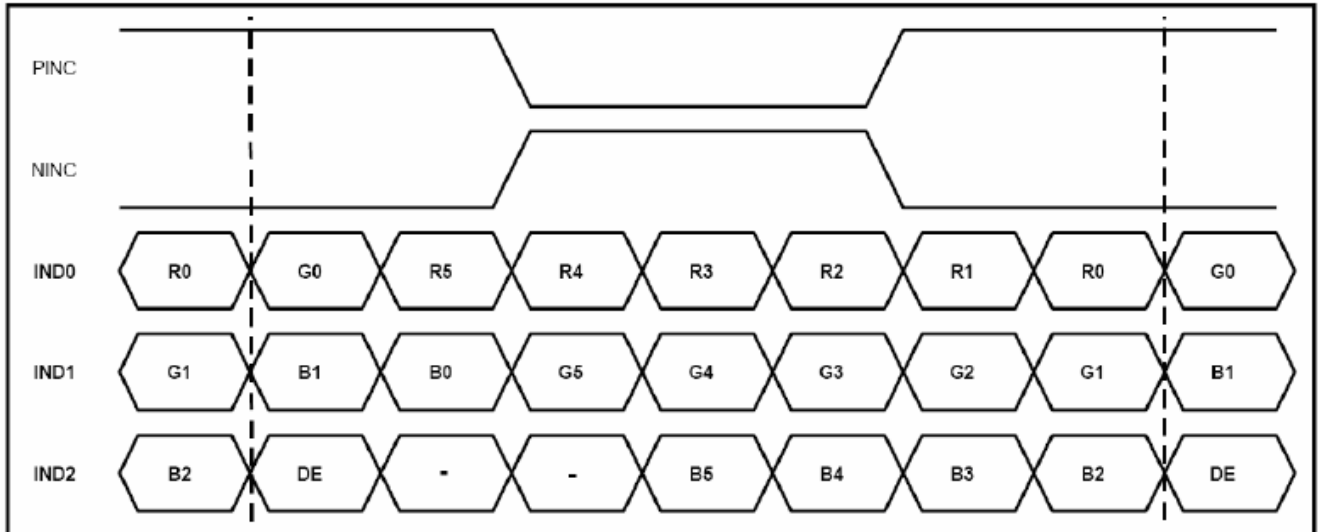

8bit LVDS input

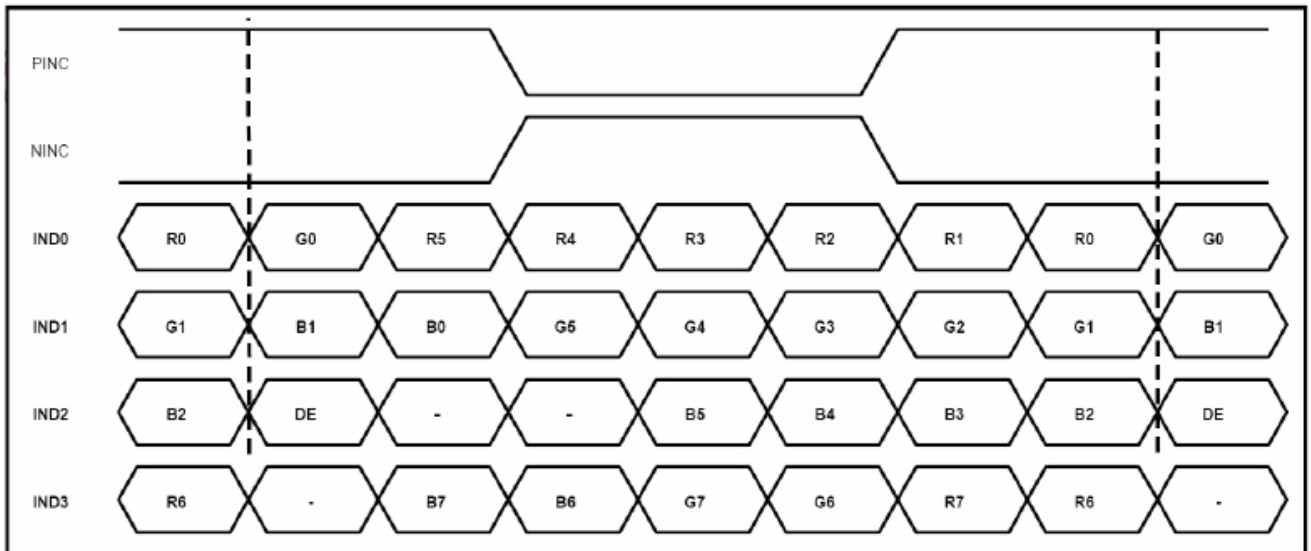

Note: Support DE timing mode only, SYNC mode not supported.

Power Sequence

Power on:

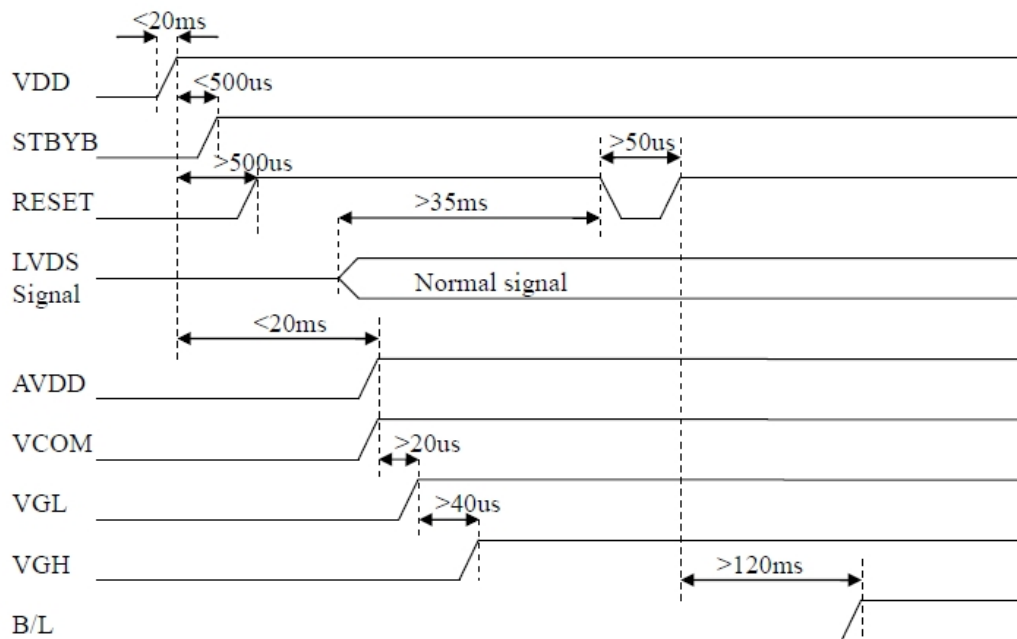

Power off:

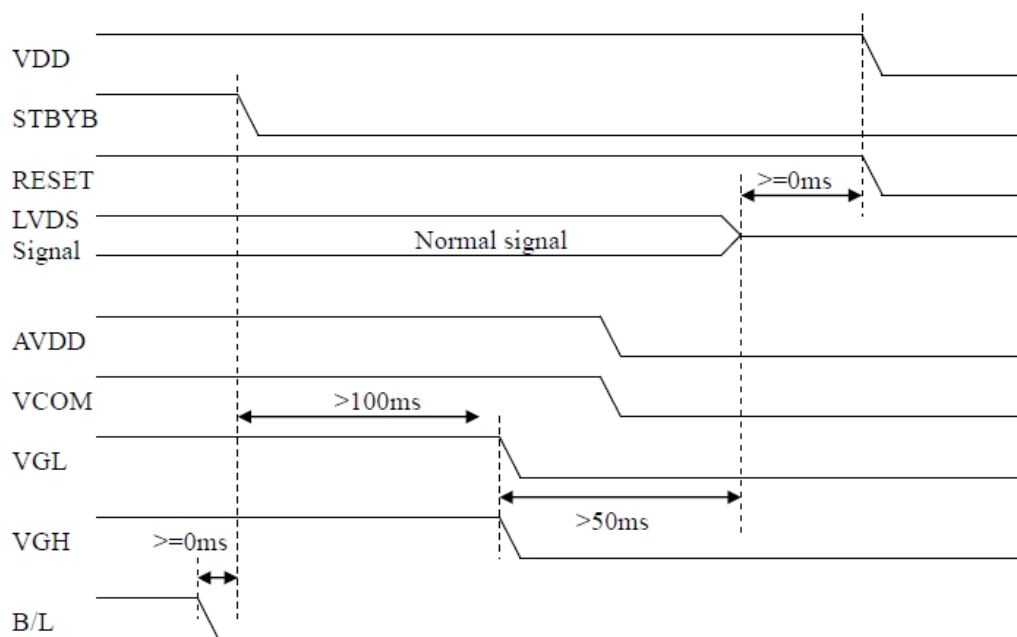

3.3 Backlight Unit

(Ta= Room Temp)

Characteristics	Symbol	Min.	Typ.	Max.	Unit	Note
Forward Voltage	VB	7.8	9.0	10.2	V	
Forward Current	IB	-	360	-	mA	(1)
Power Consumption	P _{BL}	-	3.24	-	W	(2)
LED Lifetime	-	30000	50000	-	hr	(3)

Note (1) LEDs in 3 series x 9 parallel type.

(2) Where $IB = 360\text{mA}$, $VB = 9.0\text{V}$, $P_{BL} = VB \times IB$

(3) The environmental conducted under ambient air flow at $Ta=25^{\circ}\text{C}\pm 2^{\circ}\text{C}$, $60\%\text{RH}\pm 5\%$

4. Optical Characteristics

4.1 Optical characteristic of the LCD

The following items are measured under stable conditions. The optical characteristics should be measured in a dark room or equivalent state with the methods.

Measuring equipment: BM-7A

Item	Symbol	Condition	Min	Type	Max	Unit	Note	
Brightness	B		480	600	--	cd/m ²		
Response Time	T _r + T _f	θ=0°	--	25	50	ms	.	
						ms		
Contrast Ratio	CR	At optimized viewing angle	600	800	--	--		
Luminance Uniformity	ΔL		70	75		%		
Color Chromaticity (CIE 1931)	White	W _x	θ=0° Normal Viewing Angle	0.260	0.310	0.360	--	BM-7A
		W _y		0.300	0.350	0.400		
Viewing Angle (6H)	Hor.	θ _R	CR≥10	75	85	--	Degree	
		θ _L		75	85	--		
	Ver.	θ _U		75	85	--		
		θ _D		75	85	--		
NTSC				50		%		

a. Test equipment setup

After stabilizing and leaving the panel alone shall be warmed up for the stable operation of LCM, the measurement should be executed. Measurement should be executed in a stable, windless, and dark room. Optical specifications are measured by Topcon BM-7(fast) with a viewing angle of 2° at a distance of 50cm and normal direction.

b. Definition of response time: Tr and Tf

The response time is defined as the following figure and shall be measured by switching the input signal for "black" and "white".

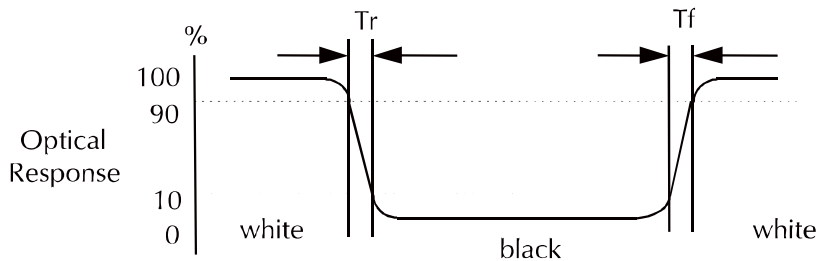

c. Definition of contrast ratio:

$$\text{Contrast Ratio (CR)} = \frac{\text{Brightness measured when LCD is at "white state"}}{\text{Brightness measured when LCD is at "black state"}}$$

- d. Measured at the center area of the panel when all the input terminals of LCD panel are electrically opened.
- e. View Angle

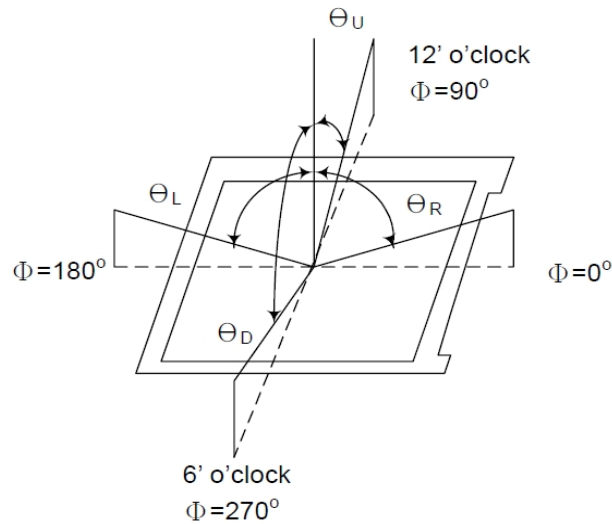

- f. Definition of Luminance of White: Luminance of white at the center points

Light Source of Back-Light Unit	LED Type
---------------------------------	----------

- g. Definition of White Uniformity

$$\text{White Uniformity} = \frac{\text{Min. luminance of white among 9-points}}{\text{Max. luminance of white among 9-points}} \times 100\%$$

5. I/O Terminal

5.1 LCD Pin Assignment

Pin No.	Symbol	I/O	Function	Remark
1	VCOM	P	Common Voltage	
2	VDD	P	Power Voltage for digital circuit	
3	VDD	P	Power Voltage for digital circuit	
4	NC	---	No connection	
5	Reset	I	Global reset pin	
6	STBYB	I	Standby mode, Normally pulled high STBYB = "1", normal operation STBYB = "0", timing controller, source driver will turn off, all output are High-Z	
7	GND	P	Ground	
8	RXIN0-	I	- LVDS differential data input	
9	RXIN0+	I	+ LVDS differential data input	
10	GND	P	Ground	
11	RXIN1-	I	- LVDS differential data input	
12	RXIN1+	I	+ LVDS differential data input	
13	GND	P	Ground	
14	RXIN2-	I	- LVDS differential data input	
15	RXIN2+	I	+ LVDS differential data input	
16	GND	P	Ground	
17	RXCLKIN-	I	- LVDS differential clock input	
18	RXCLKIN+	I	+ LVDS differential clock input	
19	GND	P	Ground	
20	RXIN3-	I	- LVDS differential data input	
21	RXIN3+	I	+ LVDS differential data input	
22	GND	P	Ground	
23	NC	---	No connection	
24	NC	---	No connection	

25	GND	P	Ground	
26	NC	---	No connection	
27	DIMO	O	Backlight CABC controller signal output	
28	SELB	I	6bit/8bit mode select	Note1
29	AVDD	P	Power for Analog Circuit	
30	GND	P	Ground	
31	NC	---	No connection	
32	NC	---	No connection	
33	L/R	I	Horizontal inversion	Note3
34	U/D	I	Vertical inversion	Note3
35	VGL	P	Gate OFF Voltage	
36	CABCEN1	I	CABC H/W enable	Note2
37	CABCEN0	I	CABC H/W enable	Note2
38	VGH	P	Gate ON Voltage	
39	NC	---	No connection	
40	NC	---	No connection	

I: input, O: output, P: Power

Note1: If LVDS input data is 6 bits ,SELB must be set to High;
If LVDS input data is 8 bits ,SELB must be set to Low.

Note2: When CABC_EN="00", CABC OFF.

When CABC_EN="01", user interface image.

When CABC_EN="10", still picture.

When CABC_EN="11", moving image.

When CABC off, don't connect DIMO, else connect it to backlight.

Note3: When L/R="0", set right to left scan direction.

When L/R="1", set left to right scan direction.

When U/D="0", set top to bottom scan direction.

When U/D="1", set bottom to top scan direction.

Note: Definition of scanning direction.
Refer to the figure as below:

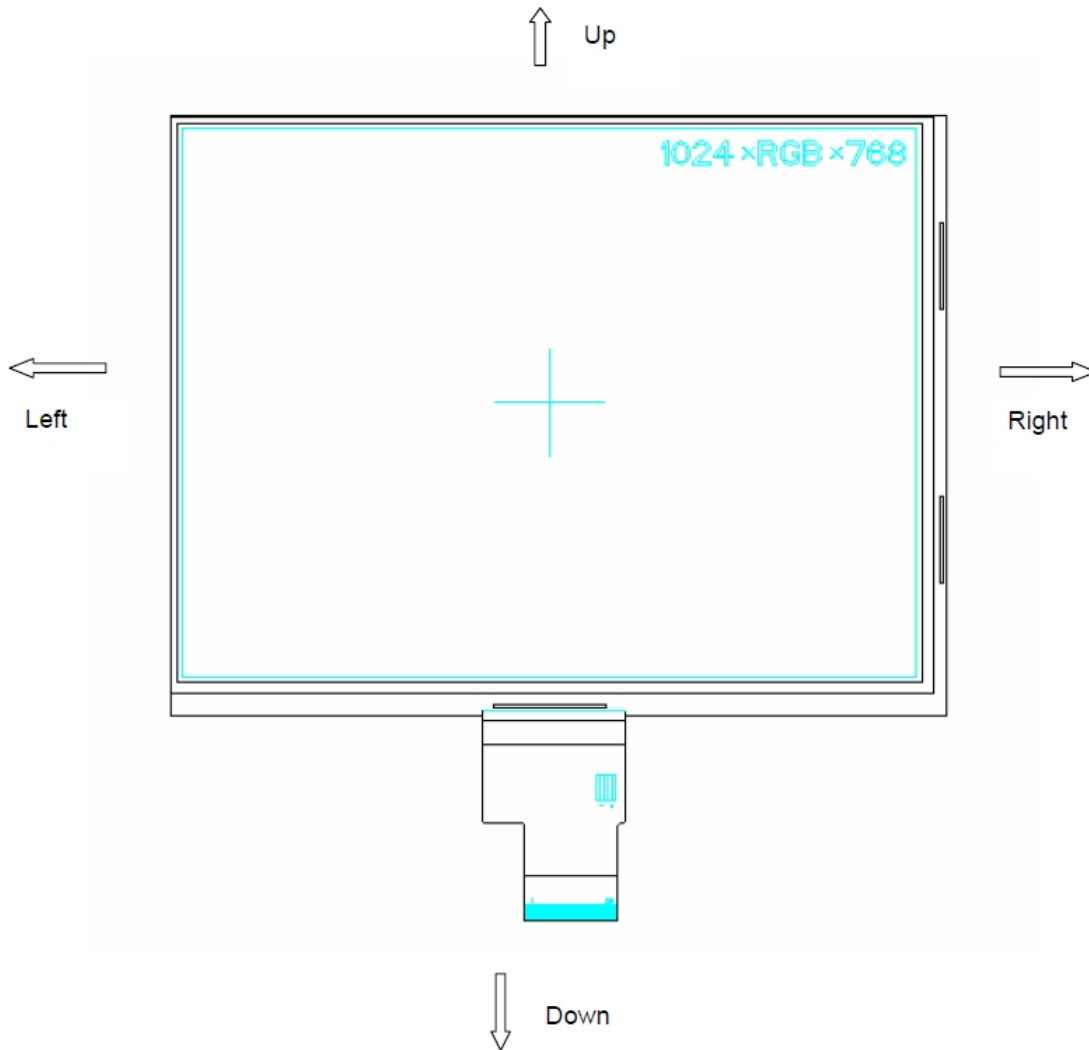

5.2 Backlight Unit (Connector Part No: JST BHSR-02VS-01 or equivalent.)

Pin No.	Symbol	Function	Remark
1	LEDA	Power Supply for LED backlight	RED
2	LEDK	GND for LED backlight	WHITE

5.3 Block Diagram

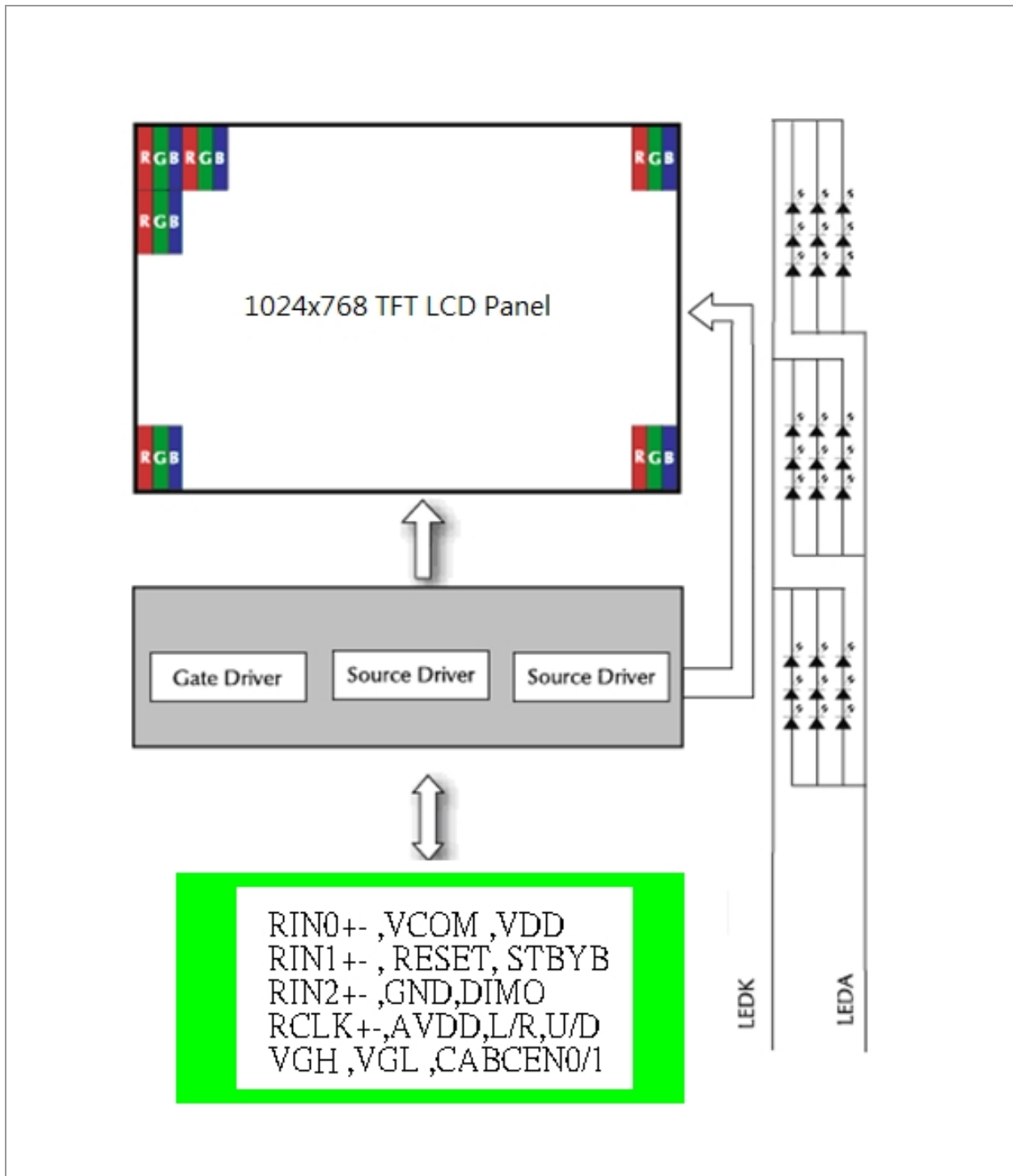

6. Displayed Color and Input Data

	Color & Gray Scale	Data Signal																	
		R5	R4	R3	R2	R1	R0	G5	G4	G3	G2	G1	G0	B5	B4	B3	B2	B1	B0
Basic Color	Black	0	0	0	0	0	0	0	0	0	0	0	0	0	0	0	0	0	0
	Red(0)	1	1	1	1	1	1	0	0	0	0	0	0	0	0	0	0	0	0
	Green(0)	0	0	0	0	0	0	1	1	1	1	1	1	0	0	0	0	0	0
	Blue(0)	0	0	0	0	0	0	0	0	0	0	0	0	1	1	1	1	1	1
	Cyan	0	0	0	0	0	0	1	1	1	1	1	1	1	1	1	1	1	1
	Magenta	1	1	1	1	1	1	0	0	0	0	0	0	1	1	1	1	1	1
	Yellow	1	1	1	1	1	1	1	1	1	1	1	1	0	0	0	0	0	0
	White	1	1	1	1	1	1	1	1	1	1	1	1	1	1	1	1	1	1
Red	Black	0	0	0	0	0	0	0	0	0	0	0	0	0	0	0	0	0	0
	Red(62)	0	0	0	0	0	1	0	0	0	0	0	0	0	0	0	0	0	0
	Red(61)	0	0	0	0	1	0	0	0	0	0	0	0	0	0	0	0	0	0
	:	:	:	:	:	:	:	:	:	:	:	:	:	:	:	:	:	:	:
	Red(31)	0	1	1	1	1	1	0	0	0	0	0	0	0	0	0	0	0	0
	:	:	:	:	:	:	:	:	:	:	:	:	:	:	:	:	:	:	:
	Red(1)	1	1	1	1	1	0	0	0	0	0	0	0	0	0	0	0	0	0
	Red(0)	1	1	1	1	1	1	0	0	0	0	0	0	0	0	0	0	0	0
Green	Black	0	0	0	0	0	0	0	0	0	0	0	0	0	0	0	0	0	0
	Green(62)	0	0	0	0	0	0	0	0	0	0	0	1	0	0	0	0	0	0
	Green(61)	0	0	0	0	0	0	0	0	0	0	1	0	0	0	0	0	0	0
	:	:	:	:	:	:	:	:	:	:	:	:	:	:	:	:	:	:	:
	Green(31)	0	0	0	0	0	0	0	1	1	1	1	0	0	0	0	0	0	0
	:	:	:	:	:	:	:	:	:	:	:	:	:	:	:	:	:	:	:
	Green(1)	0	0	0	0	0	0	1	1	1	1	1	0	0	0	0	0	0	0
	Green(0)	0	0	0	0	0	0	1	1	1	1	1	1	0	0	0	0	0	0
Blue	Black	0	0	0	0	0	0	0	0	0	0	0	0	0	0	0	0	0	0
	Blue(62)	0	0	0	0	0	0	0	0	0	0	0	0	0	0	0	0	0	1
	Blue(61)	0	0	0	0	0	0	0	0	0	0	0	0	0	0	0	0	1	0
	:	:	:	:	:	:	:	:	:	:	:	:	:	:	:	:	:	:	:
	Blue(31)	0	0	0	0	0	0	0	0	0	0	0	0	0	1	1	1	1	1
	:	:	:	:	:	:	:	:	:	:	:	:	:	:	:	:	:	:	:
	Blue(1)	0	0	0	0	0	0	0	0	0	0	0	0	1	1	1	1	1	0
	Blue(0)	0	0	0	0	0	0	0	0	0	0	0	0	1	1	1	1	1	1

0 : Low level voltage, 1 :High level voltage

Each basic color can be displayed in 64 gray scales from 6 bit data signals. With the combination of total 18 bit data signals, the 262,144-color display can be achieved on the screen.

7. Reliability Condition

No change on display and in operation under the following test condition.

Condition: Unless otherwise specified, tests will be conducted under the following condition.

Temperature: 20°C±5°C.

Humidity: 65%±5%RH.

Tests will be not conducted under functioning state.

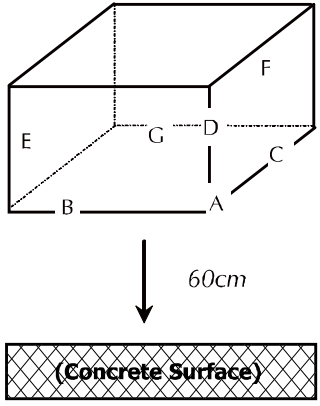
No.	Parameter	Condition	Notes
1	High Temperature Operating	+50°C±2°C, 240hrs.	
2	Low Temperature Operating	-10°C±2°C, 240hrs.	1
3	High Temperature Storage	+60°C±2°C, 240hrs.	2
4	Low Temperature Storage	-20°C±2°C, 240hrs.	1,2
5	High Temperature and High Humidity Operation Test	+40°C±2°C, 90%, 240hrs.	1,2
6	Thermal Shock (non Operation)	-10°C/30min~+50°C/30min for a total 10 cycles.	1,2
6	Vibration Test	Total fixed amplitude: 1.5mm. Vibration Frequency: 10~55Hz. One cycle 60 seconds to 3 direction of X, Y, Z each 15 minutes.	3
7.	Drop Test	To be measured after dropping from 60cm high on the concrete surface in packing state.  <i>Dropping method corner dropping:</i> <i>A corner: Once edge dropping.</i> <i>B, C, D edge: Once face dropping.</i> <i>E, F, G face: Once.</i>	

- Notes:
1. No dew condensation to be observed.
 2. The function test shall be conducted after 4 hours storage at the normal temperature and humidity after removed from the test chamber.
 3. Vibration test will be conducted to the product itself without putting I in a container.

8. Dimensional Outlines

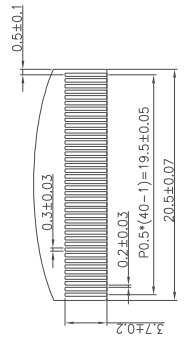
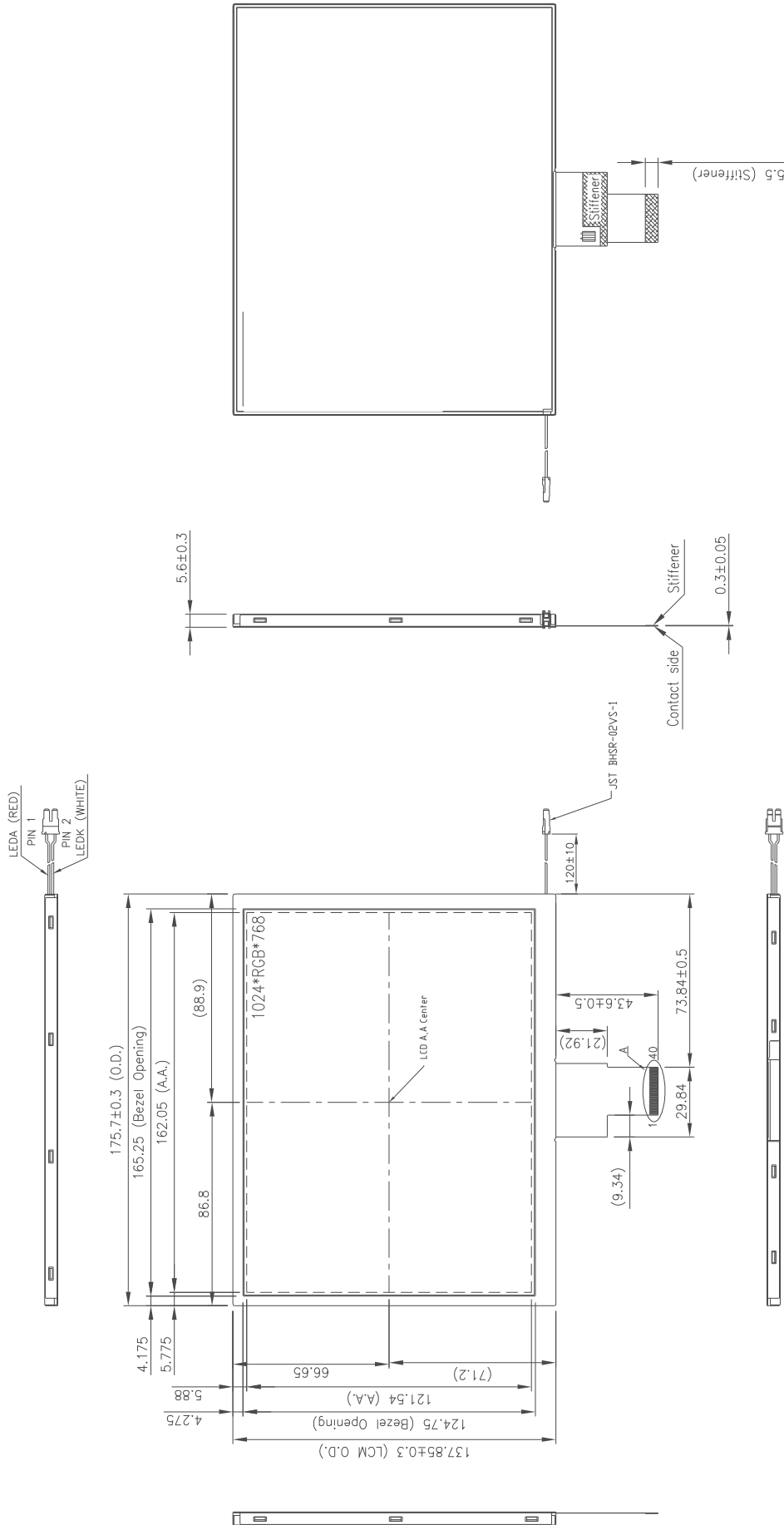

Detail "A"
Scale 4/1

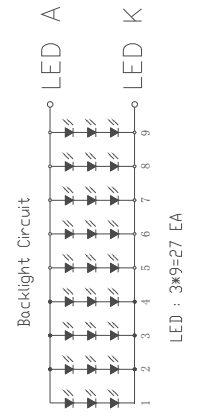

- Note:
1. General tolerance : +/- 0.3mm.
 2. LCD mating connector : Molex 54104-4031 or equivalent .

9. Incoming Inspection Standards

9.1 Inspection and Environment Conditions

9.1.1 Inspection Conditions:

- (1) Inspection Distance: 35 cm±5cm
- (2) View Angle : Light-on Inspection Angle : ±5°
Cosmetic Inspection Angle : ±45°

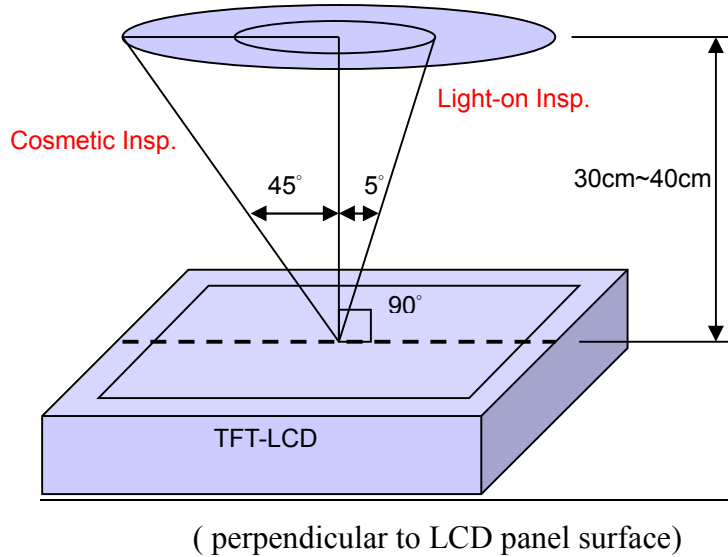

9.1.2 Environment Conditions:

Ambient Temperature		23°C ±5°C
Ambient Humidity		55±10%RH
Ambient Illumination	Cosmetic Inspection	more than 600 Lux
	Functional Inspection	300~500 Lux

9.1.3 Sampling Conditions:

- (1) Lot Size: Quantity of shipment lot per model
- (2) Sampling Method:

Sampling Plan		MIL-STD-105E
		Normal Inspection, Single Sampling
		Level II
AQL	Major Defect	1.0%
	Minor Defect	1.5%

(3) The classification of Major(MA) and Minor(MI) defects is shown as 3. Inspection Criteria.

9.1.4 Inspection Criteria

9.1.4.1 Cosmetic Inspection(Panel):

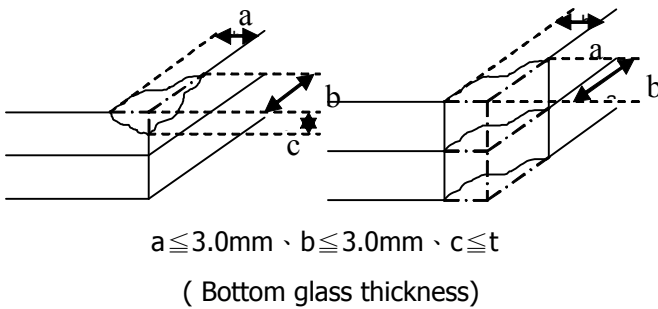
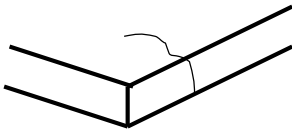
Item	Judgment Criteria	Classification
Chipping on Panel	 <p>$a \leq 3.0\text{mm}$ · $b \leq 3.0\text{mm}$ · $c \leq t$ (Bottom glass thickness)</p>	MA
Scratch on Panel *Note-2	<p>$W \leq 0.05\text{mm}$ or $L < 5\text{mm}$: Ignored $0.05\text{mm} < W \leq 0.1\text{mm}$ and $L \leq 5\text{mm}$: $N \leq 5$ $W > 0.1\text{mm}$ or $L > 5\text{mm}$: Not allowed</p>	MI
Bubble or Dent on Panel *Note-3	<p>$D \leq 0.2\text{mm}$: Ignored $0.2\text{mm} < D \leq 0.3\text{mm}$: $N \leq 5$ $D > 0.3\text{mm}$: Not allowed</p>	MI
Panel Crack	 <p>Not Allowed crack</p>	MA
Bezel Deformation	Obvious deformation is not allowed.	MI
Bezel Oxidation	Not allowed if it rusts continuously over 1 cm (It is out of warranty with rusted tin plate)	MI
Bezel Scratch	$L \leq 20\text{mm}$, $W \leq 0.2$, $N \leq 3$	MI
Metal Squash Dent /Flange(Front Side)	$D(W) \leq 1, L \leq 3, N \leq 3;$	MI
B/L High Voltage Wire Denudation	Not allowed	MA
Polarizer flaw or leak out resin	Defect is defined as the active area.	MI
Outline Dimension	Must in Spec, refer to related product spec.	MI

9.1.4.2 Functional Inspection:

Item	Judgment Criteria			Classification
	Area(Note1)	I	O	
Point Defect	Bright dot	Random	2	
		2 dots adjacent	0	0
		3 dots adjacent or more	0	0
	Dark dot	Random	3	
		2 dots adjacent	1	
		3 dots adjacent or more	0	0
	Total Dot Defect		5	
	Distance	Distance between Bright and Bright dot	$L \geq 5\text{mm}$	
		Distance between Bright and Dark dot	$L \geq 5\text{mm}$	
		Distance between Dark dot	$L \geq 5\text{mm}$	
(1) It is defined as Point Defect if defect area $> 0.5\text{dot}$ (2) It is ignored if defect area $\leq 0.5\text{dot}$ (3) Weak point defect will be defined as Bright Dot if it can be observed through ND filter 5% (Full Screen Black Inspection)				
Line Defect	Obvious vertical or horizontal line defect is not allowed.			MA
Mura	Not allowed if it can be observed through ND Filter 5 %			MI
Foreign Material in spot shape *Note-3	$D \leq 0.2\text{mm}$: Ignored $0.2\text{mm} < D \leq 0.5\text{mm}$: $N \leq 8$ $D > 0.5\text{mm}$: Not allowed			MI
Foreign Material in line or spiral shape *Note-4	$W \leq 0.05\text{mm}$ or $L \leq 5\text{mm}$: Ignored $0.05\text{mm} < W \leq 0.2\text{mm}$ and $L 1.0\text{mm} \leq 5\text{mm}$: $N \leq 8$ $W > 0.2\text{mm}$ or $L > 5\text{mm}$: Not allowed			MI
Display Function Abnormal	No Malfunction can be allowed			MA

Note-1 : I/O Area Definition

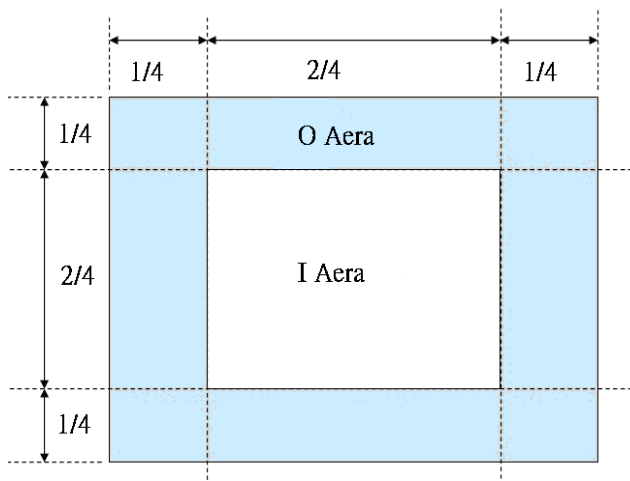

Note-2 : Polarizer Scratch

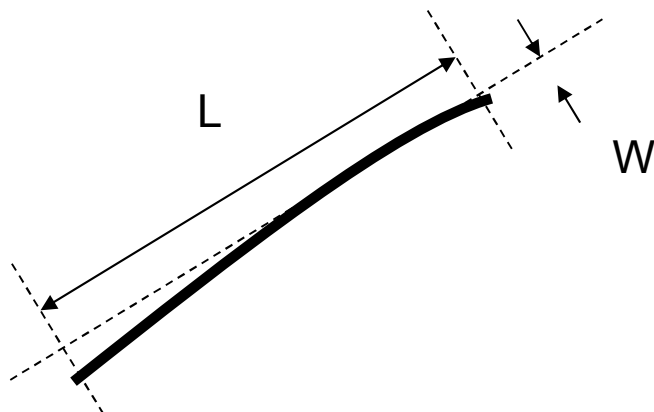

Note-3 : Spot Foreign Material
($W \geq L / 4$)

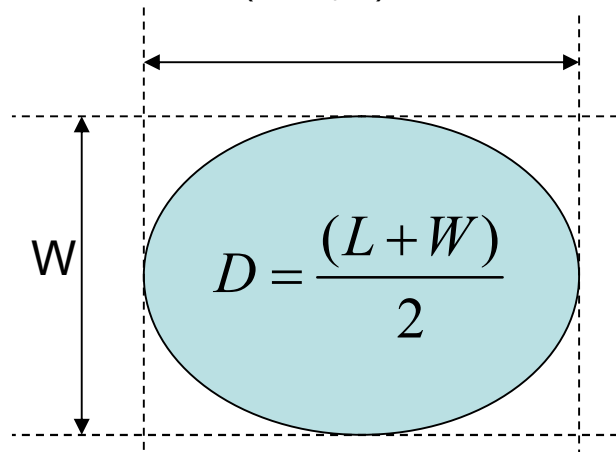

Note-4 : Line or Spiral Foreign Material
($W < L / 4$)

