

Display Elektronik GmbH

# DATA SHEET

***TFT MODULE***

**DEM 800320A2 TMH-PW-N**

**4,6" TFT**

Product Specification

Ver.: 7

**08.05.2018**

**Revision History**

<b>Revision</b>	<b>Date</b>	<b>Detail</b>	<b>Remarks</b>
0	04.12.2013	Initial Release	-
1	10.03.2014	Add weight Modify Chromaticity Transmissive Modify Inspection Specification Modify Reliability Specification	P4 P6 P14 P20
2	26.07.2014	Change the LCD panel supplier Modify DC Characteristics Modify Contrast ratio Modify Timing Chart Modify Inspection Specification	P4 P6 P11,12 P16
3	16.07.2015	Modify Optical Characteristics Modify Standard for Quality Test Modify Outline Drawing	P6 P14 P24
4	18.07.2015	Modify Packing	internal
5	22.08.2016	Modify External Gamma Modify Timing Characteristics Modify Outline Drawing	P12 P25
6	05.02.2018	Modify Driver IC	All Pages
7	08.05.2018	Modify Many Details	All Pages

**Table of Contents**

No.	Item	Page
1.	General Description .....	4
2.	Module Parameter.....	4
3.	Absolute Maximum Ratings .....	4
4.	DC Characteristics .....	5
5.	Backlight Characteristic.....	5
	5.1. Backlight Characteristics .....	5
	5.2. Backlighting circuit .....	5
6.	Optical Characteristics .....	6
	6.1. Optical Characteristics.....	6
	6.2. Definition of Response Time.....	6
	6.3. Definition of Contrast Ratio.....	7
	6.4. Definition of Viewing Angles .....	7
	6.5. Definition of Color Appearance .....	8
	6.6. Definition of Surface Luminance, Uniformity and Transmittance.....	8
7.	Block Diagram and Power Supply .....	9
8.	Interface Pins Definition .....	10
9.	Timing Chart.....	11
	9.1. Data Input Format.....	11
	9.2. Timing Parameters.....	12
	9.3. Input Clock and Data Timing Diagram .....	13
10.	Quality Assurance .....	14
	10.1 Purpose.....	14
	10.2 Standard for Quality Test .....	14
	10.3 Nonconforming Analysis & Disposition .....	14
	10.4 Agreement Items .....	14
	10.5 Standard of the Product Visual Inspection.....	15
	10.6 Inspection Specification .....	16
	10.7 Classification of Defects .....	19
	10.8 Identification/marketing criteria .....	19
	10.9 Packing .....	19
11.	Reliability Specification.....	21
12.	Precautions and Warranty.....	22
	12.1 Safety.....	22
	12.2 Handling.....	22
	12.3 Storage.....	22
	12.4 Metal Pin (Apply to Products with Metal Pins).....	22
	12.5 Operation .....	24
	12.6 Static Electricity.....	24
	12.7 Limited Warranty.....	24
13.	Outline Drawing.....	24

## 1. General Description

The specification is a transmissive type color active matrix liquid crystal display (LCD) which uses amorphous thin film transistor (TFT) as switching devices. This product is composed of a TFT-LCD panel, driver ICs and a backlight unit.

## 2. Module Parameter

Features	Details	Unit
Display Size (Diagonal)	4.6"	-
LCD Type	TN TFT	-
Display Mode	Normally White / Transmissive	-
Resolution	800 x RGB x 320	Pixels
View Direction	12 O'clock	Best Image
Gray Scale Inversion Direction	6 O'clock	-
Module Outline	120.70 x 57.08 x 3.10 (Note1 )	mm
Active Area	108.00 x 43.20	mm
Pixel Size	0.135 x 0.135	mm
Pixel Arrangement	R.G.B Vertical Stripe	-
Polarizer Surface Treatment	Anti-Glare	-
Driver IC	ILI6126C & ILI5960D	-
Display Colors	16.7 Million	-
Interface	24-Bit RGB Interface	-
With or Without Touch Panel	Without	-
Operating Temperature	-20°C ~ +70°C	°C
Storage Temperature	-30°C ~ +80°C	°C
Weight	~ 42	g

Note 1: Exclusive hooks, posts, FFC/FPC tail etc.

## 3. Absolute Maximum Ratings

$V_{SS}=0V$ ,  $T_a=25^\circ C$

Item	Symbol	Min.	Max.	Unit
Supply Voltage	VDD	-0.5	5.0	V
Storage Temperature	T <sub>STG</sub>	-30	+80	°C
Operating Temperature	T <sub>OP</sub>	-20	+70	°C

Note 1: If  $T_a$  below +50°C, the maximal humidity is 90%RH, if  $T_a$  over +50°C, absolute humidity should be less than 60%RH.

Note 2: The response time will be extremely slow when the operating temperature is around -10°C, and the back ground will become darker at high temperature operating.

4. DC Characteristics

Item	Symbol	Min.	Typ.	Max.	Unit
Supply Voltage	VDD	2.7	3.3	3.6	V
Logic Low Input Voltage	V <sub>IL</sub>	GND	-	0.3*VDD	V
Logic High Input Voltage	V <sub>IH</sub>	0.7*VDD	-	VDD	V
Logic Low Output Voltage	V <sub>OL</sub>	-	-	GND+0.4	V
Logic High Output Voltage	V <sub>OH</sub>	VDD-0.4	-	-	V
Current Consumption	I <sub>CC+</sub> I <sub>IN</sub>	-	TBD	-	mA
All Black					
	Analog				

5. Backlight Characteristic

5.1. Backlight Characteristics

Item	Symbol	Condition	Min.	Typ.	Max.	Unit
Forward Voltage	V <sub>F</sub>	Ta=25 °C, I <sub>F</sub> =20mA/LED	16.8	19.2	20.4	V
Forward Current	I <sub>F</sub>	Ta=25 °C, V <sub>F</sub> =3.2V	-	60	-	mA
Power Dissipation	P <sub>D</sub>		-	1152	-	mW
LED Lifetime (25 °C)	-	-	20000	30000	-	Hr
Uniformity	Avg		75	80	-	%
Drive Method	Constant current					
LED Configuration	18 White LEDs (6 LEDs in one string and 3 groups in parallel)					

Note: LED life time defined as follows: The final brightness is at 70% of original brightness.

The environmental conducted under ambient air flow, at Ta=25°C±2°C, 60%RH±5%, I<sub>F</sub>≤20mA.

5.2. Backlighting Circuit

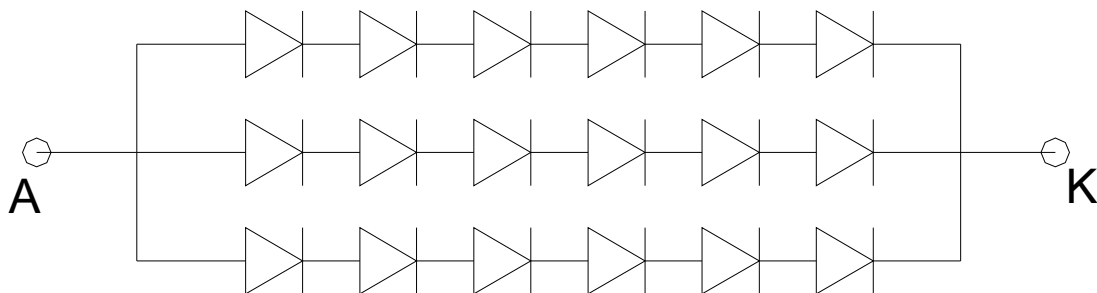

6. Optical Characteristics

6.1. Optical Characteristics

Ta=25°C, V<sub>DD</sub>=3.3V

	Item	Symbol	Condition	Specification			Unit	
				Min.	Typ.	Max.		
Backlight On (Transmissive Mode)	Luminance on TFT(I <sub>f</sub> =20mA/LED)	Lv	Normally Viewing Angle θ <sub>x</sub> = φ <sub>y</sub> = 0°	410	520	-	cd/m <sup>2</sup>	
	Contrast Ratio(See 6.3)	CR		300	500	-		
	Response Time (See 6.2)	T <sub>R</sub> +T <sub>F</sub>		-	20	-	ms	
	Chromaticity Transmissive (See 6.5)	Red	X <sub>R</sub>	Center CR≥10	0.565	0.615	0.665	
			Y <sub>R</sub>		0.309	0.359	0.409	
		Green	X <sub>G</sub>		0.256	0.306	0.356	
			Y <sub>G</sub>		0.578	0.628	0.678	
		Blue	X <sub>B</sub>		0.097	0.147	0.197	
			Y <sub>B</sub>		0.067	0.117	0.167	
	White	X <sub>W</sub>	0.215	0.265	0.315			
Y <sub>W</sub>		0.282	0.332	0.382				
Viewing Angle (See 6.4)	Horizontal	θ <sub>x+</sub>	Center CR≥10	60	65	-	Deg.	
		θ <sub>x-</sub>		60	65	-		
	Vertical	φ <sub>y+</sub>		45	50	-		
		φ <sub>y-</sub>		55	60	-		
NTSC Ratio(Gamut)				-	50	-	%	

6.2. Definition of Response Time

6.2.1. Normally Black Type (Negative)

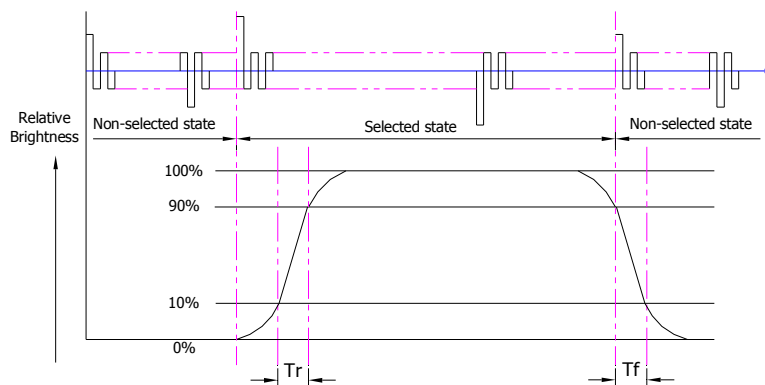

Tr is the time it takes to change from non-selected stage with relative luminance 10% to selected state with relative luminance 90%;

Tf is the time it takes to change from selected state with relative luminance 90% to non-selected state with relative luminance 10%

Note: Measuring machine: LCD-5100

6.2.2. Normally White Type (Positive)

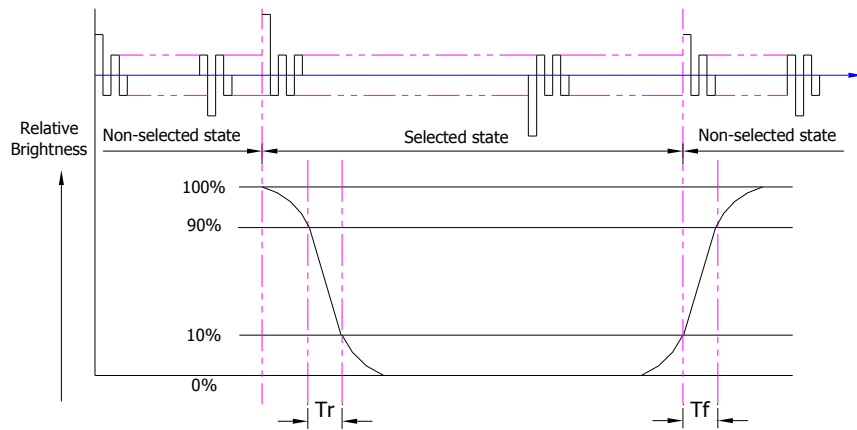

Tr is the time it takes to change from non-selected state with relative luminance 90% to selected state with relative luminance 10%;

Tf is the time it takes to change from selected state with relative luminance 10% to non-selected state with relative luminance 90%;

Note: Measuring machine: LCD-5100 or EQUI

6.3. Definition of Contrast Ratio

Contrast is measured perpendicular to display surface in reflective and transmissive mode. The measurement condition is:

Measuring Equipment	Eldim or Equivalent
Measuring Point Diameter	3mm//1mm
Measuring Point Location	Active Area centre point
Test pattern	A: All Pixels white
	B: All Pixel black
Contrast setting	Maximum

Definitions: CR (Contrast) = Luminance of White Pixel / Luminance of Black Pixel

6.4. Definition of Viewing Angles

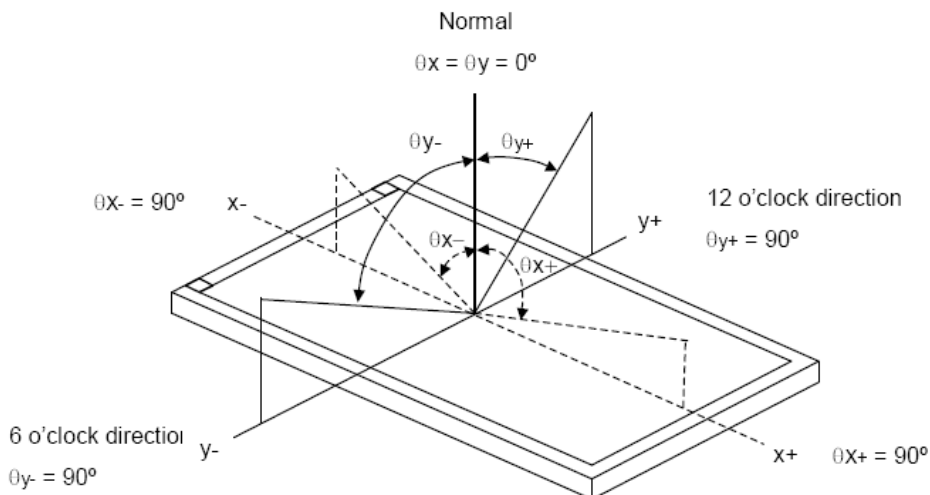

Measuring machine: LCD-5100 or EQUI

**6.5. Definition of Color Appearance**

R,G,B and W are defined by (x, y) on the IE chromaticity diagram

NTSC=area of RGB triangle/area of NTSC triangleX100%

Measuring picture: Red, Green, Blue and White (Measuring machine: BM-7)

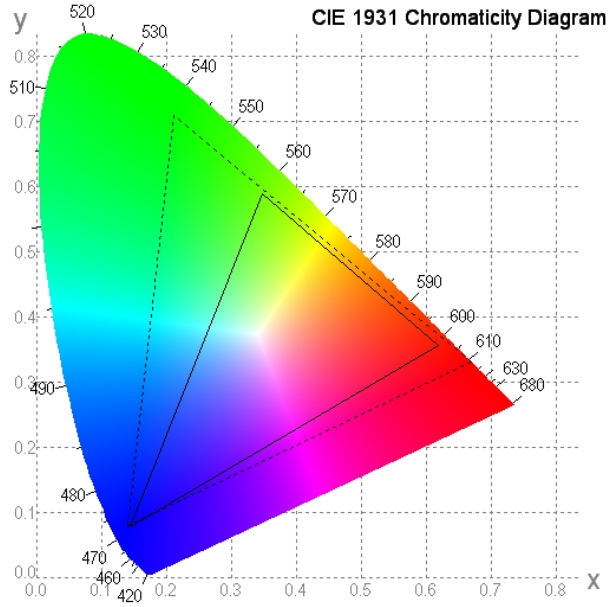

**6.6. Definition of Surface Luminance, Uniformity and Transmittance**

Using the transmissive mode measurement approach, measure the white screen luminance of the display panel and backlight.

- 6.6.1. Surface Luminance:  $L_v = \text{average} (L_{P1}:L_{P9})$
- 6.6.2. Uniformity =  $\text{Minimal} (L_{P1}:L_{P9}) / \text{Maximal} (L_{P1}:L_{P9}) * 100\%$
- 6.6.3. Transmittance =  $L_v \text{ on LCD} / L_v \text{ on Backlight} * 100\%$

Note: Measuring machine: BM-7

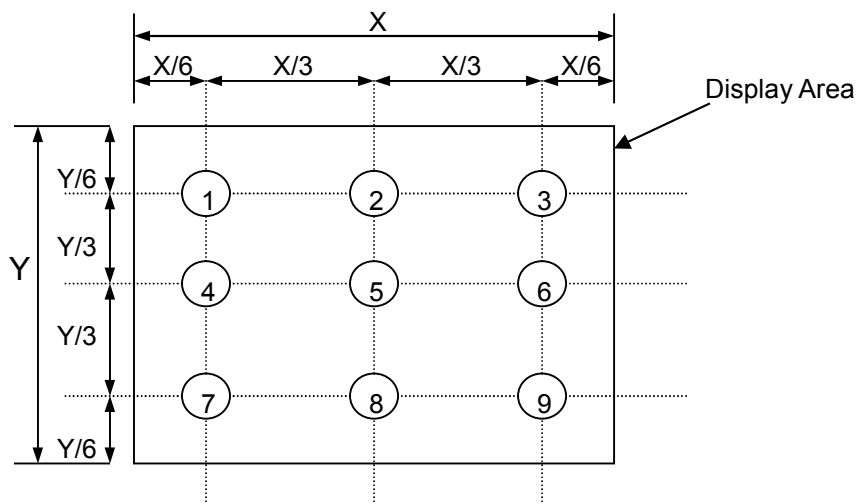



**7. Block Diagram and Power Supply**

Vertical input Format

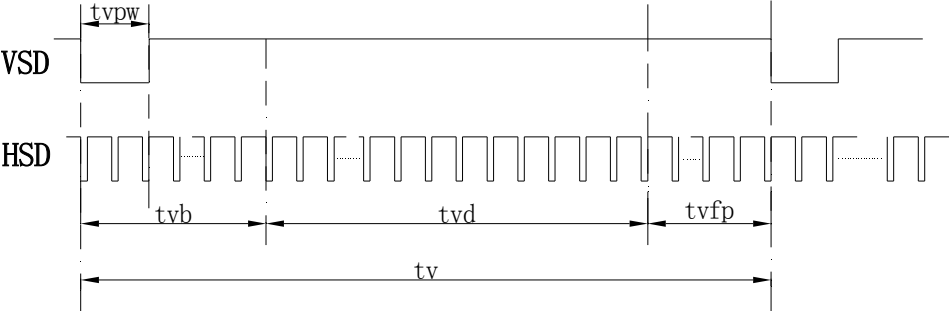

## 8. Interface Pins Definition

No.	Symbol	Function	Remark
1	VLED-	Ground(Cathode)	
2	VLED+	LED Input Terminal(Anode)	
3	GND	Power voltage	
4	VDD	Power voltage	
5	R0	Red data(LSB)	
6	R1	Red data	
7	R2	Red data	
8	R3	Red data	
9	R4	Red data	
10	R5	Red data	
11	R6	Red data	
12	R7	Red data(MSB)	
13	G0	Green data(LSB)	
14	G1	Green data	
15	G2	Green data	
16	G3	Green data	
17	G4	Green data	
18	G5	Green data	
19	G6	Green data	
20	G7	Green data(MSB)	
21	B0	Blue data(LSB)	
22	B1	Blue data	
23	B2	Blue data	
24	B3	Blue data	
25	B4	Blue data	
26	B5	Blue data	
27	B6	Blue data	
28	B7	Blue data(MSB)	
29	GND	Ground	
30	CLKIN	Clock for input data. Data latched at rising edge of this signal	
31	STBYB	Display on/off	
32	HSD	Horizontal sync signal	
33	VSD	Vertical sync signal	
34	DEN	Data enable. (In SYNC mode this pin should not be used.)	
35	NC	No connection	
36	GND	Ground	
37	NC(XR)	No connection	
38	NC(YD)	No connection	
39	NC(XL)	No connection	
40	NC(YU)	No connection	

9. Timing Chart

9.1. Data Input Format

Vertical input Format

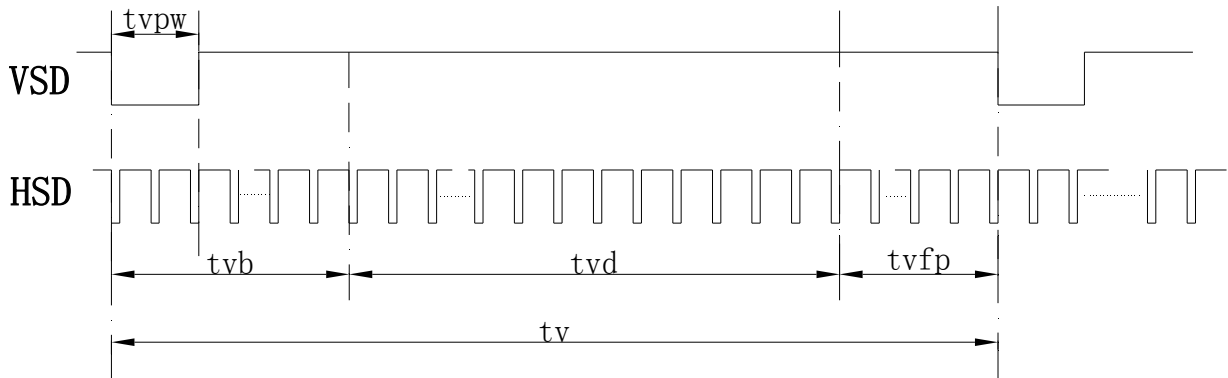

Horizontal input timing

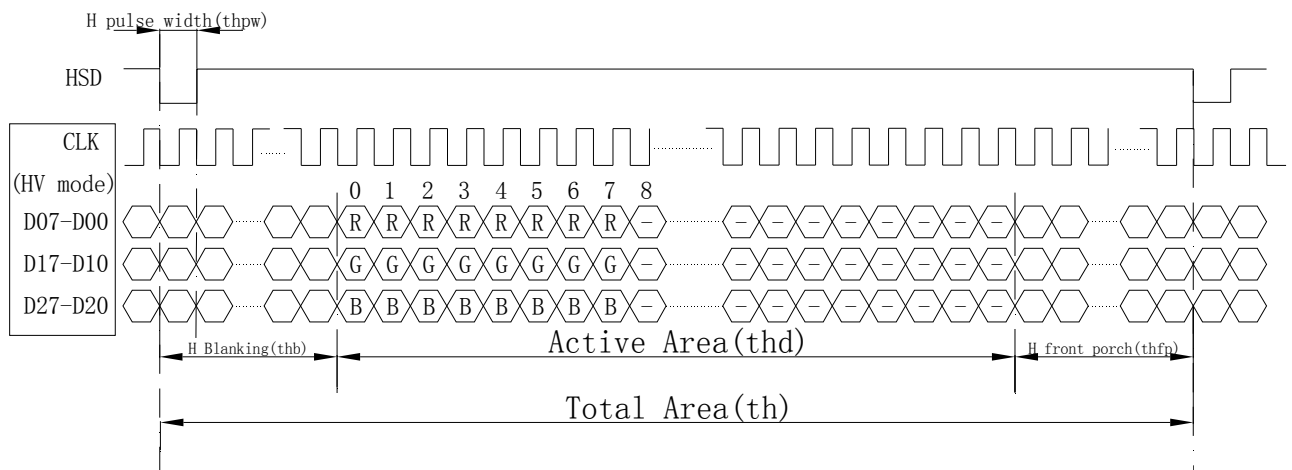

## 9.2. Timing Parameters

## Horizontal Input Timing

Parameter	Symbol	Value			Unit
		Min.	Typ.	Max.	
Horizontal display area	thd	800			DCLK
DCLK frequency	fclk	-	30	-	MHZ
1 Horizontal Line	th	898			DCLK
HSD pulse width	thpw	Min.	1		
		Typ.	2		
		Max.	-		
HSD Back Porch(Blanking)	thb	-	88	-	
HSD Front Porch	thfp	-	10	-	

## Vertical Input Timing

Parameter	Symbol	Value			Unit
		Min.	Typ.	Max.	
Vertical display area	tvd	320			H
VSD period time	tv	-	524	-	H
VSD pulse width	tvpw	-	2	-	H
VSD Back Porch(Blanking)	tvb	-	191	-	H
VSD Front Porch	tvfp	-	13	-	H

9.3. Input Clock and Data Timing Diagram

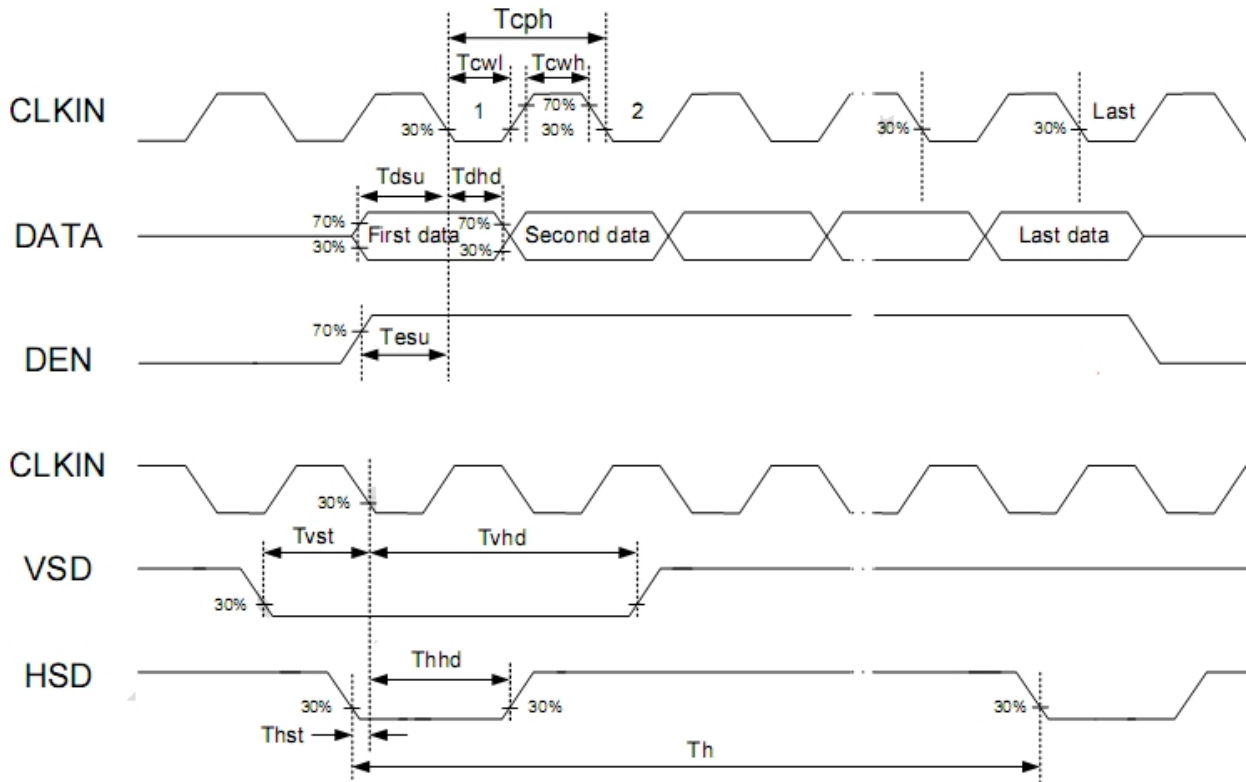

Parallel 24-bit RGB mode

Parameter	Symbol	Min.	Typ.	Max.	Unit	Conditions
CLKIN Frequency	Fclk	-	33	50	MHz	VDD = 2.7V ~3.6V
CLKIN Cycle Time	Tclk	20	30	-	ns	
CLKIN Pulse Duty	Tcwh	40	50	60	%	Tclk
Time from HSD to Source Output	Thso	-	64	-	CLKIN	
Time from HSD to LD	Thld	-	64	-	CLKIN	
Time from HSD to STV	Thstv	-	2	-	CLKIN	
Time from HSD to CKV	Thckv	-	20	-	CLKIN	
Time from HSD to OEV	Thoev	-	4	-	CLKIN	
LD Pulse Width	Twd	-	10	-	CLKIN	
CKV Pulse Width	Twckv	-	66	-	CLKIN	
OEV Pulse Width	Twoev	-	92	-	CLKIN	

## **10. Quality Assurance**

### **10.1 Purpose**

This standard for Quality Assurance assures the quality of LCD module products supplied to customer.

### **10.2 Standard for Quality Test**

#### 10.2.1 Sampling Plan:

GB2828.1-2012

Single sampling, normal inspection

#### 10.2.2 Sampling Criteria:

Visual inspection: AQL 1.5%

Electrical functional: AQL 0.65%.

#### 10.2.3 Reliability Test:

Detailed requirement refer to Reliability Test Specification.

### **10.3 Nonconforming Analysis & Disposition**

#### 10.3.1 Nonconforming analysis:

10.3.1.1 Customer should provide overall information of non-conforming sample for their complaints.

10.3.1.2 After receipt of detailed information from customer, the analysis of nonconforming parts usually should be finished in one week.

10.3.1.3 If cannot finish the analysis on time, customer will be notified with the progress status.

#### 10.3.2 Disposition of nonconforming:

10.3.2.1 Non-conforming product over PPM level will be replaced.

10.3.2.2 The cause of non-conformance will be analyzed. Corrective action will be discussed and implemented.

### **10.4 Agreement Items**

Shall negotiate with customer if the following situation occurs:

10.4.1 There is any discrepancy in standard of quality assurance.

10.4.2 Additional requirement to be added in product specification.

10.4.3 Any other special problem.

**10.5 Standard of the Product Visual Inspection**

10.5.1 Appearance inspection:

10.5.1.1 The inspection must be under illumination about 1000 – 1500 lx, and the distance of view must be at 30cm ± 2cm.

10.5.1.2 The viewing angle should be 45° from the vertical line without reflection light or follows customer's viewing angle specifications.

10.5.1.3 Definition of area: A Zone: Active Area, B Zone: Viewing Area,

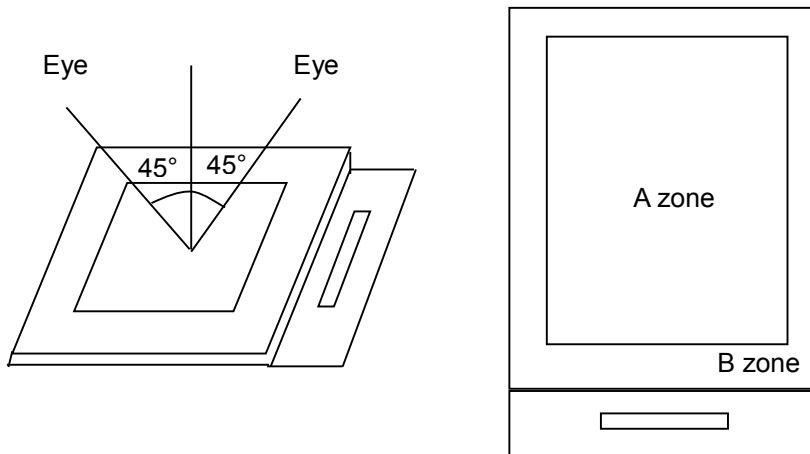

10.5.2 Basic principle:

10.5.2.1 A set of sample to indicate the limit of acceptable quality level must be discussed by both us and customer when there is any dispute happened.

10.5.2.2 New item must be added on time when it is necessary.

10.6 Inspection Specification

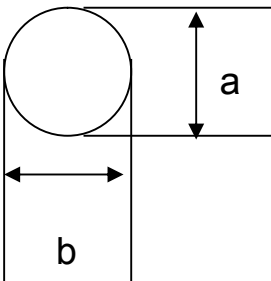
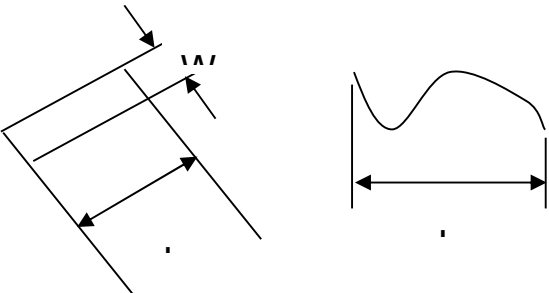
No	Item	Criteria (Unit: mm)																		
01	Black / White spot Foreign material (Round type) Pinholes Stain Particles inside cell. (Minor defect)	 $\phi = (a + b) / 2$ <table border="1" data-bbox="938 369 1444 712"> <thead> <tr> <th>Size</th> <th>Area</th> <th>Acc. Qty</th> </tr> </thead> <tbody> <tr> <td><math>\phi \leq 0.10</math></td> <td></td> <td>Ignore</td> </tr> <tr> <td><math>0.10 &lt; \phi \leq 0.15</math></td> <td></td> <td>2</td> </tr> <tr> <td><math>0.15 &lt; \phi \leq 0.25</math></td> <td></td> <td>1</td> </tr> <tr> <td><math>0.25 &lt; \phi</math></td> <td></td> <td>0</td> </tr> <tr> <td>Total</td> <td></td> <td>2 no include <math>\phi \leq 0.10</math></td> </tr> </tbody> </table> <p>Distance between 2 defects should more than 5mm apart.</p>	Size	Area	Acc. Qty	$\phi \leq 0.10$		Ignore	$0.10 < \phi \leq 0.15$		2	$0.15 < \phi \leq 0.25$		1	$0.25 < \phi$		0	Total		2 no include $\phi \leq 0.10$
Size	Area	Acc. Qty																		
$\phi \leq 0.10$		Ignore																		
$0.10 < \phi \leq 0.15$		2																		
$0.15 < \phi \leq 0.25$		1																		
$0.25 < \phi$		0																		
Total		2 no include $\phi \leq 0.10$																		
02	Electrical Defect (Minor defect)	<table border="1" data-bbox="518 817 1385 1030"> <thead> <tr> <th>Bright dot</th> <th>Display Area</th> <th>Total</th> <th rowspan="2">Note1</th> </tr> </thead> <tbody> <tr> <td></td> <td>0</td> <td>0</td> </tr> <tr> <td>Dark dot</td> <td><math>N \leq 2</math></td> <td><math>N \leq 2</math></td> </tr> <tr> <td>Total dot</td> <td><math>N \leq 2</math></td> <td><math>N \leq 2</math></td> </tr> <tr> <td>Mura</td> <td colspan="2">Not visible through 5% ND filters.</td> <td>Note 2</td> </tr> </tbody> </table> <p>Remark: 1. Bright dot caused by scratch and foreign object accords to item 1.</p>	Bright dot	Display Area	Total	Note1		0	0	Dark dot	$N \leq 2$	$N \leq 2$	Total dot	$N \leq 2$	$N \leq 2$	Mura	Not visible through 5% ND filters.		Note 2	
Bright dot	Display Area	Total	Note1																	
	0	0																		
Dark dot	$N \leq 2$	$N \leq 2$																		
Total dot	$N \leq 2$	$N \leq 2$																		
Mura	Not visible through 5% ND filters.		Note 2																	
03	Black and White line Scratch Foreign material (Line type) (Minor defect)	 <table border="1" data-bbox="577 1563 1204 1825"> <thead> <tr> <th>Length</th> <th>Width</th> <th>Acc. Qty</th> </tr> </thead> <tbody> <tr> <td>/</td> <td><math>W \leq 0.1</math></td> <td>Ignore</td> </tr> <tr> <td><math>L \leq 2.5</math></td> <td><math>0.1 &lt; W \leq 0.2</math></td> <td>3</td> </tr> <tr> <td><math>L &gt; 2.5</math></td> <td><math>0.2 &lt; W</math></td> <td>0</td> </tr> <tr> <td colspan="2">Total</td> <td>3</td> </tr> </tbody> </table> <p>Distance between 2 defects should more than 3mm apart. Scratches not viewable through the back of the display are acceptable.</p>	Length	Width	Acc. Qty	/	$W \leq 0.1$	Ignore	$L \leq 2.5$	$0.1 < W \leq 0.2$	3	$L > 2.5$	$0.2 < W$	0	Total		3			
Length	Width	Acc. Qty																		
/	$W \leq 0.1$	Ignore																		
$L \leq 2.5$	$0.1 < W \leq 0.2$	3																		
$L > 2.5$	$0.2 < W$	0																		
Total		3																		

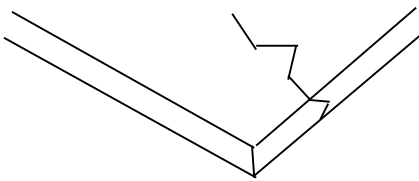
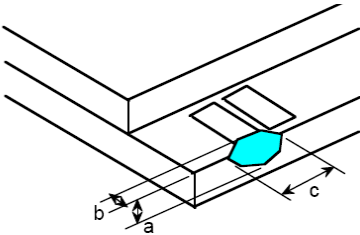
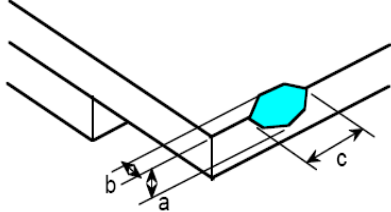
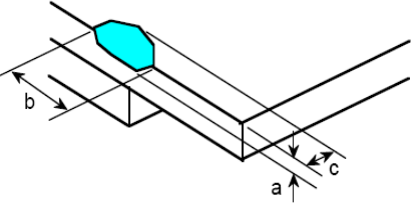
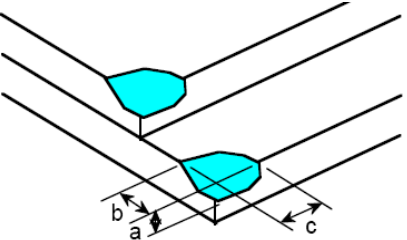

<p>04</p>	<p>Glass Crack (Minor defect)</p>	 <p>Crack is potential to enlarge, any type is not allowed.</p>										
<p>05</p>	<p>Glass Chipping Pad Area: (Minor defect)</p> 	<table border="1"> <thead> <tr> <th>Length and Width</th> <th>Acc. Qty</th> </tr> </thead> <tbody> <tr> <td><math>c &gt; 3.0, b &lt; 1.0</math></td> <td>1</td> </tr> <tr> <td><math>c &lt; 3.0, b &lt; 1.0</math></td> <td>3</td> </tr> <tr> <td colspan="2"><math>a &lt; \text{Glass Thickness}</math></td> </tr> </tbody> </table>	Length and Width	Acc. Qty	$c > 3.0, b < 1.0$	1	$c < 3.0, b < 1.0$	3	$a < \text{Glass Thickness}$			
Length and Width	Acc. Qty											
$c > 3.0, b < 1.0$	1											
$c < 3.0, b < 1.0$	3											
$a < \text{Glass Thickness}$												
<p>06</p>	<p>Glass Chipping Rear of Pad Area: (Minor defect)</p> 	<table border="1"> <thead> <tr> <th>Length and Width</th> <th>Acc. Qty</th> </tr> </thead> <tbody> <tr> <td><math>c &gt; 3.0, b &lt; 1.0</math></td> <td>1</td> </tr> <tr> <td><math>c &lt; 3.0, b &lt; 1.0</math></td> <td>2</td> </tr> <tr> <td><math>c &lt; 3.0, b &lt; 0.5</math></td> <td>4</td> </tr> <tr> <td colspan="2"><math>a &lt; \text{Glass Thickness}</math></td> </tr> </tbody> </table>	Length and Width	Acc. Qty	$c > 3.0, b < 1.0$	1	$c < 3.0, b < 1.0$	2	$c < 3.0, b < 0.5$	4	$a < \text{Glass Thickness}$	
Length and Width	Acc. Qty											
$c > 3.0, b < 1.0$	1											
$c < 3.0, b < 1.0$	2											
$c < 3.0, b < 0.5$	4											
$a < \text{Glass Thickness}$												
<p>07</p>	<p>Glass Chipping Except Pad Area: (Minor defect)</p> 	<table border="1"> <thead> <tr> <th>Length and Width</th> <th>Acc. Qty</th> </tr> </thead> <tbody> <tr> <td><math>c &gt; 3.0, b &lt; 1.0</math></td> <td>1</td> </tr> <tr> <td><math>c &lt; 3.0, b &lt; 1.0</math></td> <td>2</td> </tr> <tr> <td><math>c &lt; 3.0, b &lt; 0.5</math></td> <td>4</td> </tr> <tr> <td colspan="2"><math>a &lt; \text{Glass Thickness}</math></td> </tr> </tbody> </table>	Length and Width	Acc. Qty	$c > 3.0, b < 1.0$	1	$c < 3.0, b < 1.0$	2	$c < 3.0, b < 0.5$	4	$a < \text{Glass Thickness}$	
Length and Width	Acc. Qty											
$c > 3.0, b < 1.0$	1											
$c < 3.0, b < 1.0$	2											
$c < 3.0, b < 0.5$	4											
$a < \text{Glass Thickness}$												
<p>08</p>	<p>Glass Corner Chipping: (Minor defect)</p> 	<table border="1"> <thead> <tr> <th>Length and Width</th> <th>Acc. Qty</th> </tr> </thead> <tbody> <tr> <td><math>c &lt; 3.0, b &lt; 3.0</math></td> <td>Ignore</td> </tr> <tr> <td colspan="2"><math>a &lt; \text{Glass Thickness}</math></td> </tr> </tbody> </table>	Length and Width	Acc. Qty	$c < 3.0, b < 3.0$	Ignore	$a < \text{Glass Thickness}$					
Length and Width	Acc. Qty											
$c < 3.0, b < 3.0$	Ignore											
$a < \text{Glass Thickness}$												

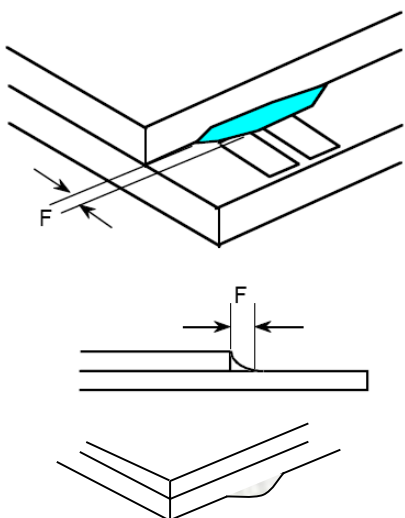
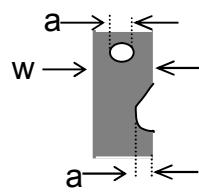
<p>09</p>	<p>Glass Burr: (Minor defect)</p> 	<table border="1" data-bbox="877 257 1348 347"> <thead> <tr> <th>Length</th> <th>Acc. Qty</th> </tr> </thead> <tbody> <tr> <td><math>F &lt; 1.0</math></td> <td>Ignore</td> </tr> </tbody> </table> <p>Glass burr don't affect assemble and module dimension.</p>	Length	Acc. Qty	$F < 1.0$	Ignore				
Length	Acc. Qty									
$F < 1.0$	Ignore									
<p>10</p>	<p>FPC Defect: (Minor defect)</p> 	<p>10.1 Dent, pinhole width <math>a &lt; w/3</math>. (w: circuitry width.) 10.2 Open circuit is unacceptable. 10.3 No oxidation, contamination and distortion.</p>								
<p>11</p>	<p>Bubble on Polarizer (Minor defect)</p>	<table border="1" data-bbox="758 1288 1220 1467"> <thead> <tr> <th>Diameter</th> <th>Acc. Qty</th> </tr> </thead> <tbody> <tr> <td><math>\varphi \leq 0.30</math></td> <td>Ignore</td> </tr> <tr> <td><math>0.30 &lt; \varphi \leq 0.50</math></td> <td><math>N \leq 2</math></td> </tr> <tr> <td><math>0.50 &lt; \varphi</math></td> <td><math>N = 0</math></td> </tr> </tbody> </table>	Diameter	Acc. Qty	$\varphi \leq 0.30$	Ignore	$0.30 < \varphi \leq 0.50$	$N \leq 2$	$0.50 < \varphi$	$N = 0$
Diameter	Acc. Qty									
$\varphi \leq 0.30$	Ignore									
$0.30 < \varphi \leq 0.50$	$N \leq 2$									
$0.50 < \varphi$	$N = 0$									
<p>12</p>	<p>Dent on Polarizer (Minor defect)</p>	<table border="1" data-bbox="758 1534 1220 1713"> <thead> <tr> <th>Diameter</th> <th>Acc. Qty</th> </tr> </thead> <tbody> <tr> <td><math>\varphi \leq 0.25</math></td> <td>Ignore</td> </tr> <tr> <td><math>0.25 &lt; \varphi \leq 0.50</math></td> <td><math>N \leq 4</math></td> </tr> <tr> <td><math>0.50 &lt; \varphi</math></td> <td>None</td> </tr> </tbody> </table>	Diameter	Acc. Qty	$\varphi \leq 0.25$	Ignore	$0.25 < \varphi \leq 0.50$	$N \leq 4$	$0.50 < \varphi$	None
Diameter	Acc. Qty									
$\varphi \leq 0.25$	Ignore									
$0.25 < \varphi \leq 0.50$	$N \leq 4$									
$0.50 < \varphi$	None									
<p>13</p>	<p>Bezel</p>	<p>13.1 No rust, distortion on the Bezel. 13.2 No visible fingerprints, stains or other contamination.</p>								

<p><b>14</b></p>	<p>Touch Panel</p>	<p>D: Diameter W: width L: length                      14.1 Spot: <math>D &lt; 0.25</math> is acceptable  <math>0.25 \leq D \leq 0.4</math>                      2dots are acceptable and the distance between defects should more than 10 mm.  <math>D &gt; 0.4</math> is unacceptable                      14.2 Dent: <math>D &gt; 0.40</math> is unacceptable                      14.3 Scratch: <math>W \leq 0.03</math>, <math>L \leq 10</math> is acceptable,  <math>0.03 &lt; W \leq 0.10</math>, <math>L \leq 10</math> is acceptable                      Distance between 2 defects should more than 10 mm.  <math>W &gt; 0.10</math> is unacceptable.</p>
<p><b>15</b></p>	<p>PCB</p>	<p>15.1 No distortion or contamination on PCB terminals.                      15.2 All components on PCB must same as documented on the BOM/component layout.                      15.3 Follow IPC-A-600F.</p>
<p><b>16</b></p>	<p>Soldering</p>	<p>Follow IPC-A-610C standard</p>
<p><b>17</b></p>	<p>Electrical Defect (Major defect)</p>	<p>The below defects must be rejected.                      17.1 Missing vertical / horizontal segment,                      17.2 Abnormal Display.                      17.3 No function or no display.                      17.4 Current exceeds product specifications.                      17.5 LCD viewing angle defect.                      17.6 No Backlight.                      17.7 Dark Backlight.                      17.8 Touch Panel no function.</p>

Remark: LCD Panel Broken shall be rejected. Defect out of LCD viewing area is acceptable.

**10.7 Classification of Defects**

10.7.1 Visual defects (Except no / wrong label) are treated as minor defect and electrical defect is major.

10.7.2 Two minor defects are equal to one major in lot sampling inspection.

**10.8 Identification/marketing criteria**

Any unit with illegible / wrong /double or no marking/ label shall be rejected.

**10.9 Packing**

10.9.1 There should be no damage of the outside carton box, each packaging box should have one identical label.

10.9.2 Modules inside package box should have compliant mark.

10.9.3 All direct package materials shall offer ESD protection

**Note1:** Bright dot is defined as the defective area of the dot is larger than 50% of one sub-pixel area.

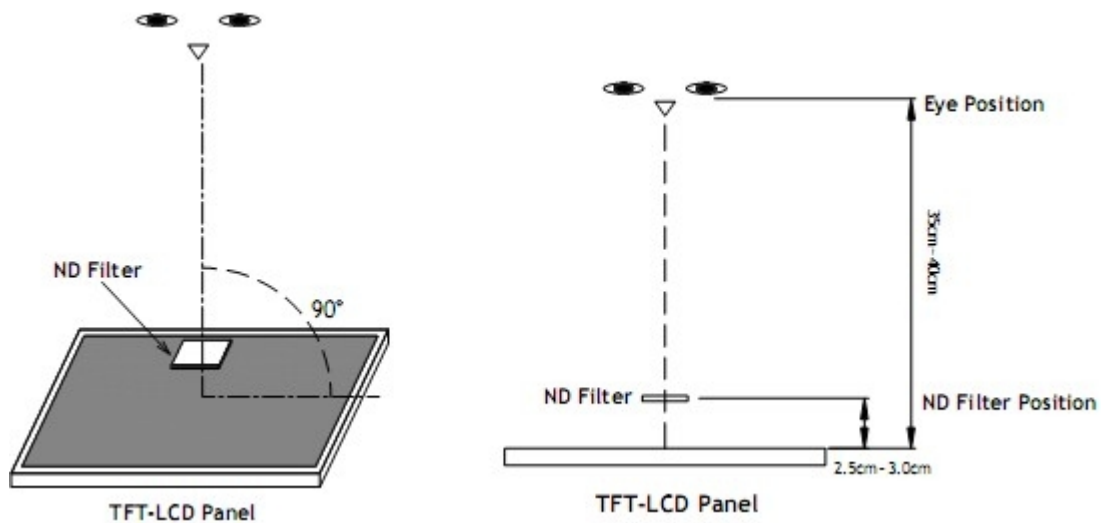

Bright dot: The bright dot size defect at black display pattern. It can be recognized by 2% transparency of filter when the distance between eyes and panel is  $350\text{mm} \pm 50\text{mm}$ .

Dark dot: Cyan, Magenta or Yellow dot size defect at white display pattern. It can be recognized by 5% transparency of filter when the distance between eyes and panel is  $350\text{mm} \pm 50\text{mm}$ .

**Note2:** Mura on display which appears darker / brighter against background brightness on parts of display area.

## 11. Reliability Specification

No	Item	Condition	Quantity	Criteria
1	High Temperature Operating	+70°C, 96Hrs	2	GB/T2423.2-2008
2	Low Temperature Operating	-20°C, 96Hrs	2	GB/T2423.1-2008
3	High Humidity	+50°C, 90%RH, 96Hrs	2	GB/T2423.3-2006
4	High Temperature Storage	+80°C, 96Hrs	2	GB/T2423.2-2008
5	Low Temperature Storage	-30°C, 96Hrs	2	GB/T2423.1-2008
6	Thermal Cycling Test	-20°C, 60min~+70°C, 60min, 20 cycles.	2	GB/T2423.22-2012
7	Packing vibration	Frequency range:10Hz~50Hz Acceleration of gravity:5G X, Y, Z 30 min for each direction.	2	GB/T5170.14-2009
8	Electrical Static Discharge	Air: ±8KV 150pF/330Ω 5 times Contact: ±4KV 150pF/330Ω 5 times	2	GB/T17626.2-2006
9	Drop Test (Packaged)	Height:80 cm,1 corner, 3 edges, 6 surfaces.	2	GB/T2423.8-1995

Note1. No deflection cosmetic and operational function allowable.

Note2. Total current Consumption should be below double of initial value

## 12. Precautions and Warranty

### 12.1 Safety

12.1.1 The liquid crystal in the LCD is poisonous. Do not put it in your mouth. If the liquid crystal touches your skin or clothes, wash it off immediately using soap and water.

12.1.2 Since the liquid crystal cells are made of glass, do not apply strong impact on them. Handle with care.

### 12.2 Handling

12.2.1 Reverse and use within ratings in order to keep performance and prevent damage.

12.2.2 Do not wipe the polarizer with dry cloth, as it might cause scratch. If the surface of the LCD needs to be cleaned, wipe it swiftly with cotton or other soft cloth soaked with petroleum IPA, do not use other chemicals.

### 12.3 Storage

12.3.1 Do not store the LCD module beyond the specified temperature ranges.

12.3.2 Strong light exposure causes degradation of polarizer and color filter.

### 12.4 Metal Pin (Apply to Products with Metal Pins)

#### 12.4.1 Pins of LCD and Backlight

12.4.1.1 Solder tip can touch and press on the tip of Pin LEAD during the soldering

#### 12.4.1.2 Recommended Soldering Conditions

Solder Type: Sn96.3~94-Ag3.3~4.3-Cu0.4~1.1

Maximum Solder Temperature: 370°C

Maximum Solder Time: 3s at the maximum temperature

Recommended Soldering Temp: 350±20°C

Typical Soldering Time: ≤3s

#### 12.4.1.3 Solder Wetting

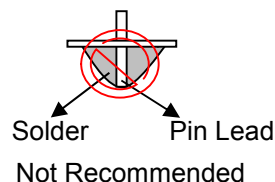
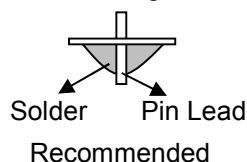

#### 12.4.2 Pins of EL

12.4.2.1 Solder tip can touch and press on the tip of EL leads during soldering.

12.4.2.2 No Solder Paste on the soldering pad on the motherboard is recommended.

#### 12.4.2.3 Recommended Soldering Conditions

Solder type: Nippon Alimit Leadfree SR-34, size 0.5mm

Recommended Solder Temperature: 270~290°C

Typical Soldering Time: ≤2s

Minimum solder distance from EL lamp (body):2.0mm

12.4.2.4 No horizontal press on the EL leads during soldering.

12.4.2.5 180° bend EL leads three times is not allowed.

12.4.2.6 Solder Wetting

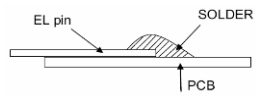

Recommended

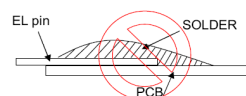

Not Recommended

12.4.2.7 The type of the solder iron:

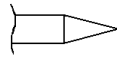

Recommended

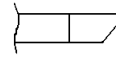

Not Recommended

12.4.2.8 Solder Pad

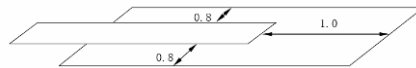

12.5 Operation

- 12.5.1 Do not drive LCD with DC voltage
- 12.5.2 Response time will increase below lower temperature
- 12.5.3 Display may change color with different temperature
- 12.5.4 Mechanical disturbance during operation, such as pressing on the display area, may cause the segments to appear "fractured".
- 12.5.5. Do not connect or disconnect the LCM to or from the system when power is on.
- 12.5.6. Never use the LCM under abnormal condition of high temperature and high humidity.
- 12.5.7. Module has high frequency circuits. Sufficient suppression to the electromagnetic interface shall be done by system manufacturers. Grounding and shielding methods may be important to minimize the interference.
- 12.5.8. Do not display the fixed pattern for long time (we suggest the time not longer than one hour) because it may develop image sticking due to the TFT structure

12.6 Static Electricity

- 12.6.1 CMOS LSIs are equipped in this unit, so care must be taken to avoid the electro-static charge, by ground human body, etc.
- 12.6.2 The normal static prevention measures should be observed for work clothes and benches.
- 12.6.3 The module should be kept into anti-static bags or other containers resistant to static for storage.

12.7 Limited Warranty

- 12.7.1 Our warranty liability is limited to repair and/or replacement. We will not be responsible for any consequential loss.
- 12.7.2 If possible, we suggest customer to use up all modules in six months. If the module storage time over twelve months, we suggest that recheck it before the module be used.
- 12.7.3 After the product shipped, any product quality issues must be feedback within three months, otherwise, we will not be responsible for the subsequent or consequential events.

13. Outline Drawing

