

IEC Appliance Inlet C14 with Filter, Circuit Breaker TA35 (recessed)



Screw-on with IP67



Screw-on A



Screw-on B

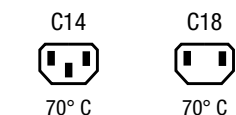

See below:  
[Approvals and Compliances](#)

**Description**

- Panel mount :  
 Screw-on or snap-in mounting from front side
- 3 Functions :  
 Appliance Inlet protection class I or II , Circuit breaker type TA35 2-pole  
 , Line filter in standard and medical version
- Quick connect terminals 6.3 x 0.8 mm

**Unique Selling Proposition**

- IP67 protection
- Recessed rocker switch
- Various mounting options
- V-Lock cord retaining

**Characteristics**

- All single elements are already wired
- Circuit Breaker non-illuminated or illuminated
- Suitable for use in equipment according to IEC/UL 60950  
 Suitable for use in medical equipment according to IEC/UL 60601-1

**Other versions on request**

- Other rocker marking
- Medical version M80
- Capacitance CX1
- Variants in white
- Filter version with high inductance

**References**

Alternative: version without line filter [DG11](#)

**Weblinks**

[pdf data sheet](#), [html data sheet](#), [General Product Information](#),  
[Distributor-Stock-Check](#), [Accessories](#), [Detailed request for product](#),  
[Landing Page](#)

**Technical Data**

Ratings IEC	1 - 10A @ Ta 40 °C / 250VAC; 50Hz
Ratings UL/CSA	1 - 15A @ Ta 40 °C / 250VAC; 60Hz
Leakage Current	standard < 0.5 mA (250V / 60Hz) medical < 5 µA (250 V / 60 Hz)
Dielectric Strength	> 1.7kVDC between L-N > 2.7kVDC between L/N-PE Test voltage (2sec)
Allowable Operation Temperature	-25 °C to 60 °C
Climatic Category	25/060/21 acc. to IEC 60068-1
IP-Protection	from front side IP40 or IP65 / IP67 acc. to IEC 60529
Protection Class	Suitable for appliances with protection class I or II acc. to IEC 61140
Terminal	Quick connect terminals 6.3 x 0.8 mm
Panel Thickness S	Screw: max 8 mm Mounting screw torque max 0.5 Nm : S =1.0/1.2/1.5/2.0/2.5/3.0 mm
Material: Housing	Thermoplastic, black, UL 94V-0

appliance inlet/-outlet	C14 C18 acc. to IEC 60320-1 UL 498, CSA C22.2 no. 42 (for cold conditions) pin-temperature 70 °C, 10A, Protection Class I or II
Circuit Breakers	Acc. IEC/EN 60934, UL 1077, CSA 22.2 no. 235 2-pole rocker switch, illuminated or non-illuminated. Optional with undervoltage- or remote trip release Short circuit capacity Icn: 2000 A
Line Filter	Standard and Medical Version, IEC 60939, UL 60939-3, CSA C22.2 no. 8 <a href="#">Technical Details</a>
MTBF	> 100'000h acc. to MIL-HB-217 F



**Approvals and Compliances**

Detailed information on product approvals, code requirements, usage instructions and detailed test conditions can be looked up in [Details about Approvals](#)

SCHURTER products are designed for use in industrial environments. They have approvals from independent testing bodies according to national and international standards. Products with specific characteristics and requirements such as required in the automotive sector according to IATF 16949, medical technology according to ISO 13485 or in the aerospace industry can be offered exclusively with customer-specific, individual agreements by SCHURTER.







### Approvals

The approval mark is used by the testing authorities to certify compliance with the safety requirements placed on electronic products.  
 Approval Reference Type: DG12

Approval Logo	Certificates	Certification Body	Description
	VDE Approvals	VDE	Certificate Number: 40049092
	UL Approvals	UL	UL File Number: E495089



### Product standards

Product standards that are referenced

Organization	Design	Standard	Description
	Designed according to	IEC 60320-1	Appliance couplers for household and similar general purposes
	Designed according to	IEC 60939	Passive filters for suppressing electromagnetic interference
	Designed according to	IEC 61058-1	Switches for appliances. Part 1. General requirements
	Designed according to	UL 498	Standard for Attachment Plugs and Receptacles
	Designed according to	UL 60939-3	Electromagnetic interference filters
	Designed according to	CSA C22.2 no. 42	General Use Receptacles, Attachment Plugs, and Similar Wiring Devices
	Designed according to	CSA C22.2 no. 8	Electromagnetic interference (EMI) filters







### Application standards

Application standards where the product can be used

Organization	Design	Standard	Description
	Designed for applications acc.	IEC/UL 60950	IEC 60950-1 includes the basic requirements for the safety of information technology equipment.
	Designed for applications acc.	IEC 60601-1	Medical electrical equipment - Part 1: General requirements for basic safety and essential performance

### Compliances

The product complies with following Guide Lines

Identification	Details	Initiator	Description
	CE declaration of conformity	SCHURTER AG	The CE marking declares that the product complies with the applicable requirements laid down in the harmonisation of Community legislation on its affixing in accordance with EU Regulation 765/2008.
	RoHS	SCHURTER AG	Directive RoHS 2011/65/EU, Amendment (EU) 2015/836
	China RoHS	SCHURTER AG	The law SJ / T 11363-2006 (China RoHS) has been in force since 1 March 2007. It is similar to the EU directive RoHS.
	REACH	SCHURTER AG	On 1 June 2007, Regulation (EC) No 1907/2006 on the Registration, Evaluation, Authorization and Restriction of Chemicals 1 (abbreviated as "REACH") entered into force.
		SCHURTER AG	V-Lock system are based on a matching plug-dose combination. The connector is equipped with a notch intended for use with the latching cordset. The cord latching system prevents against accidental removal of the cordset.
	Medical Equipment	SCHURTER AG	Suitable for use in medical equipment according to IEC/UL 60601-1

Dimensions [mm]

Snap-in version

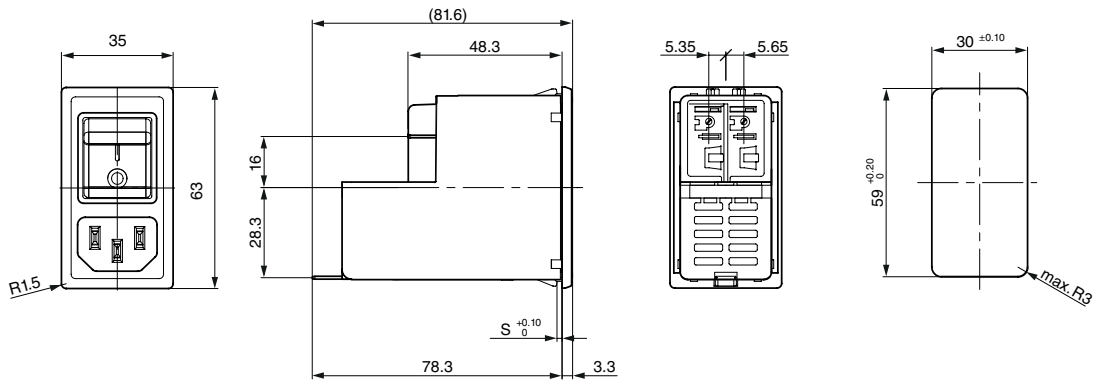

Screw-on A

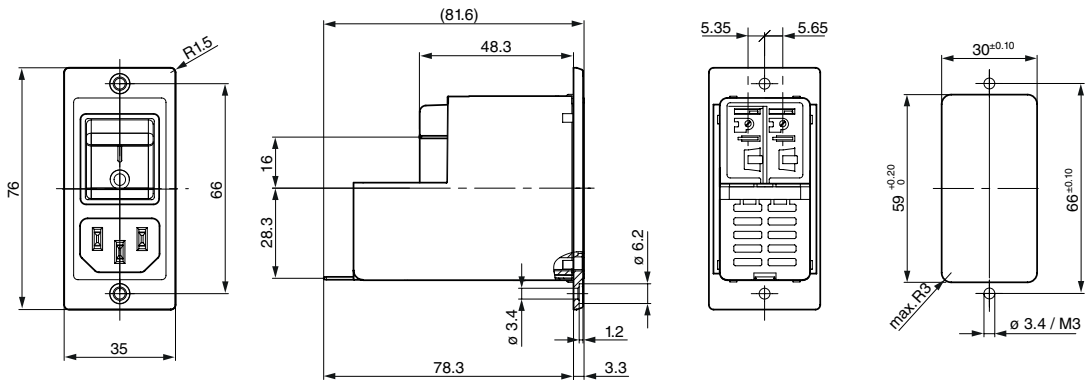

Screw-on B

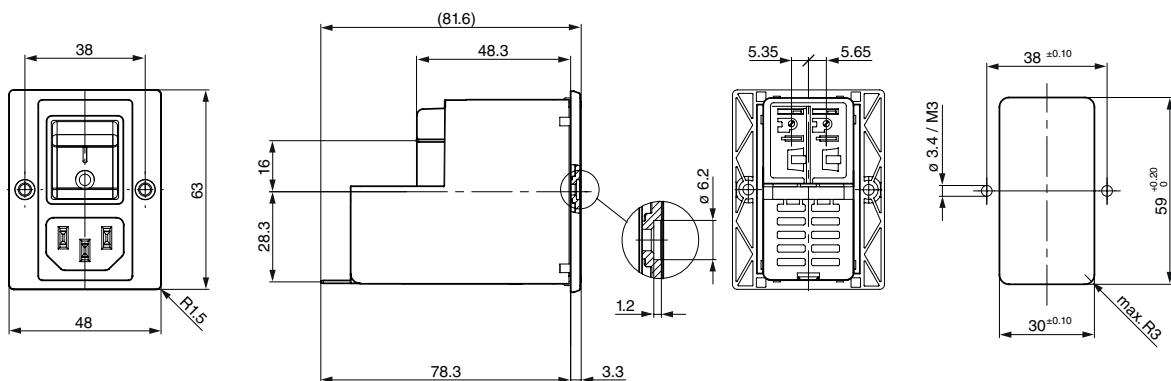

Screw-on with IP67

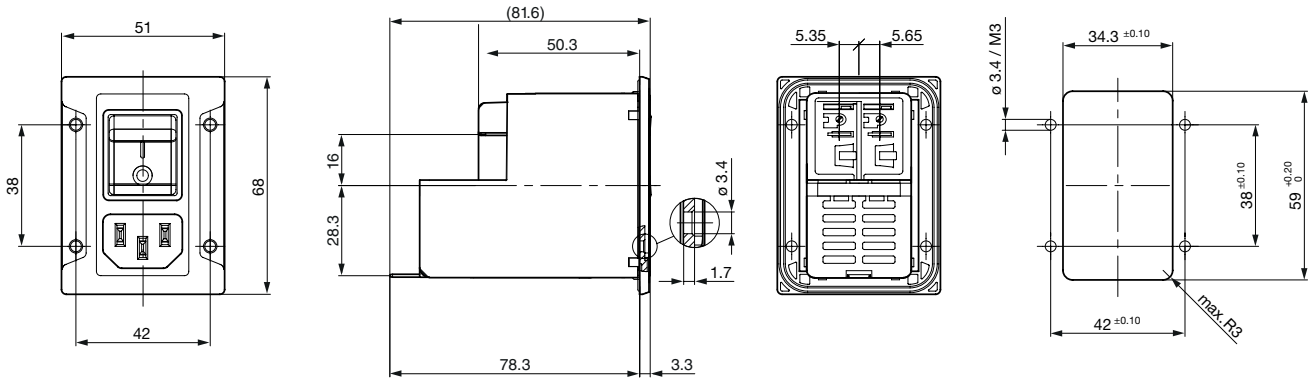

**Technical Data of Filter-Components**

Rated Current [A]	Filter-Type	Inductances L [mH]	Capacitance CX [nF]	Capacitance CY [nF]	R [MΩ]
1	Standard Version	2 x 12	220	2.2	1
2	Standard Version	2 x 5.2	220	2.2	1
3	Standard Version	2 x 4	220	2.2	1
4	Standard Version	2 x 2	220	2.2	1
6	Standard Version	2 x 0.8	220	2.2	1
8	Standard Version	2 x 0.6	220	2.2	1
10	Standard Version	2 x 0.4	220	2.2	1
15	Standard Version	2 x 0.1	220	2.2	1
10	Medical Version (M5)	2 x 0.4	220	-	1

**Diagrams**

Standard Version, medical Version M80

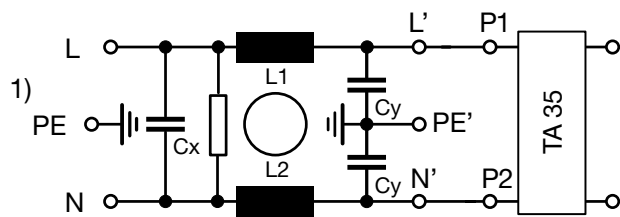

1) Line, 2) Load

Medical version M5, protection class I

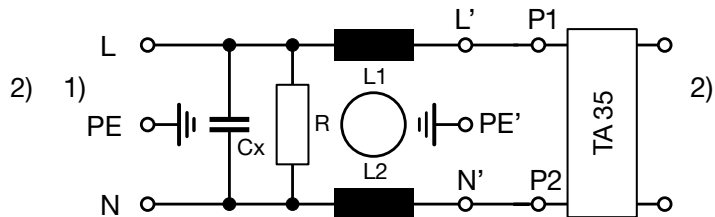

1) Line, 2) Load

Medical version M5, protection class II

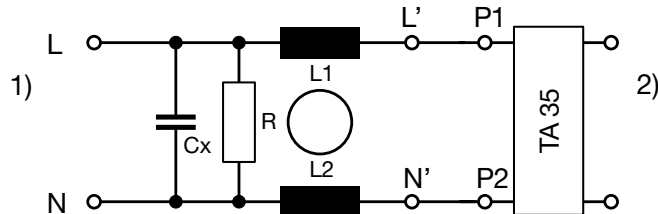

1) Line  
 2) Load

**Attenuation Loss**

--- 50Ω differential mode    \_\_\_\_ 50Ω common mode

Standard version

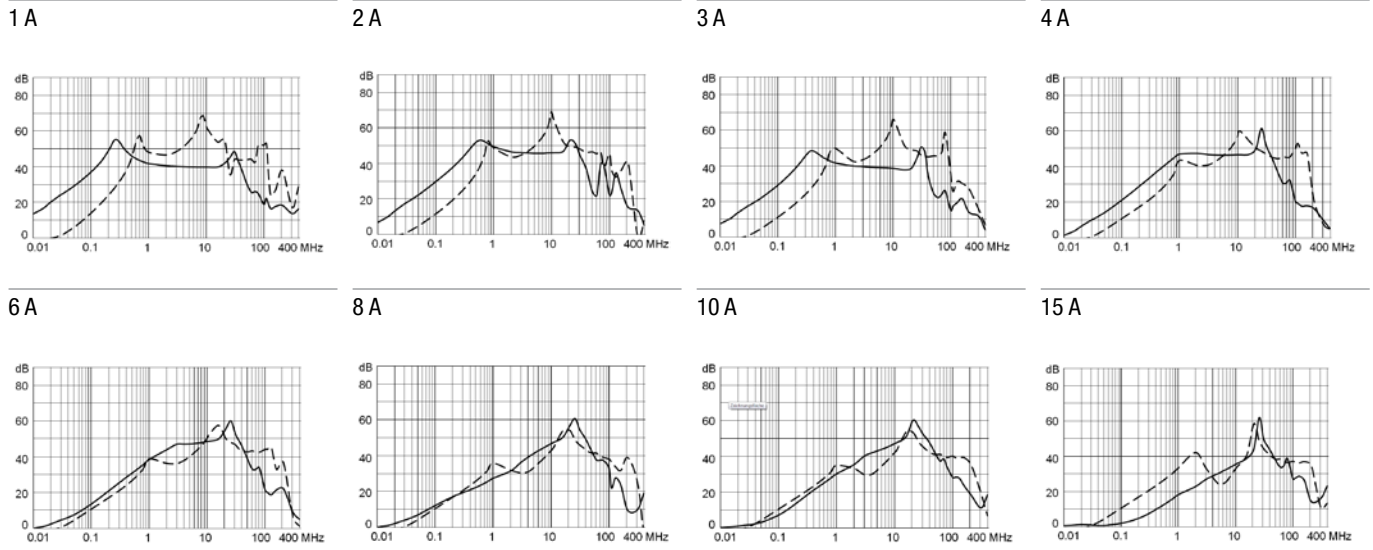

Medical version (M5)

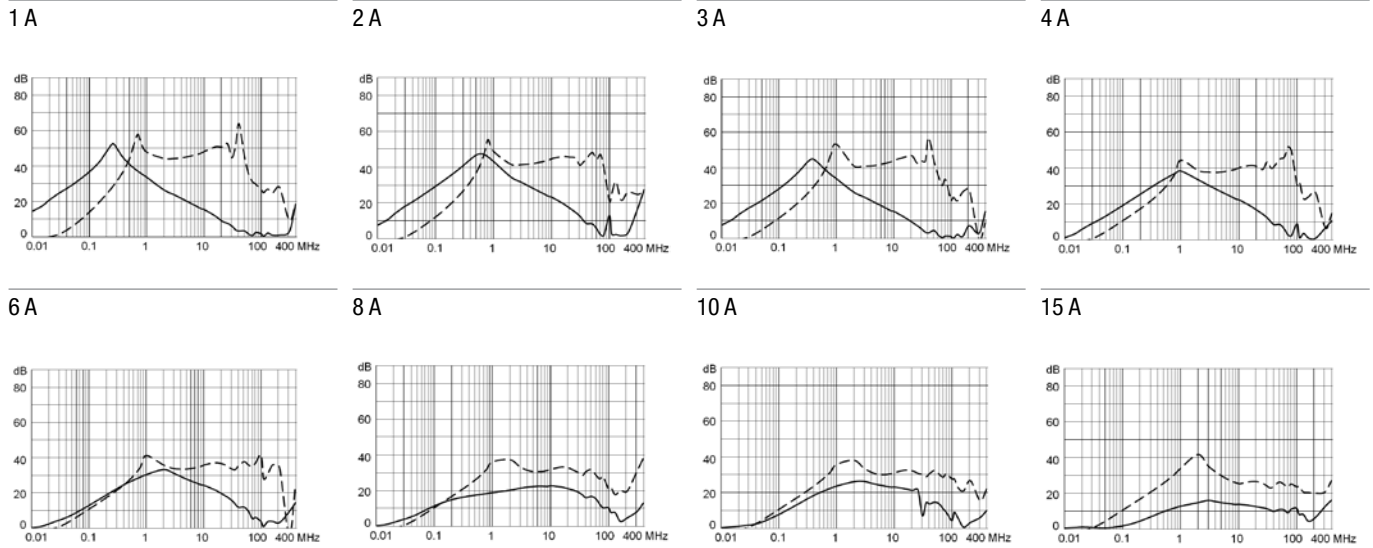

**Effect of ambient temperature**

Ambient Temperature [°C]	Correction factor
-30	0.76
-20	0.81
0	0.90
+23	1.00
+40	1.03
+50	1.04
+60	1.06

**Time-Current-Curves**

Tripping Characteristics  $I_n < 3 \text{ A}$

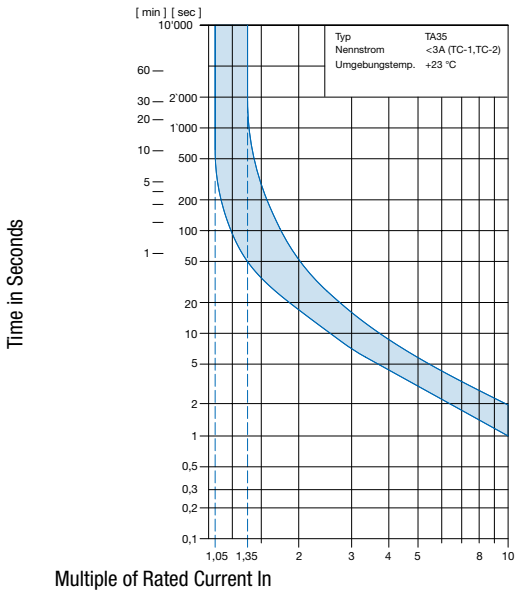

Multiple of Rated Current In

Reference Temperature +23°

Tripping Characteristics  $I_n \geq 3 \dots \leq 15 \text{ A}$

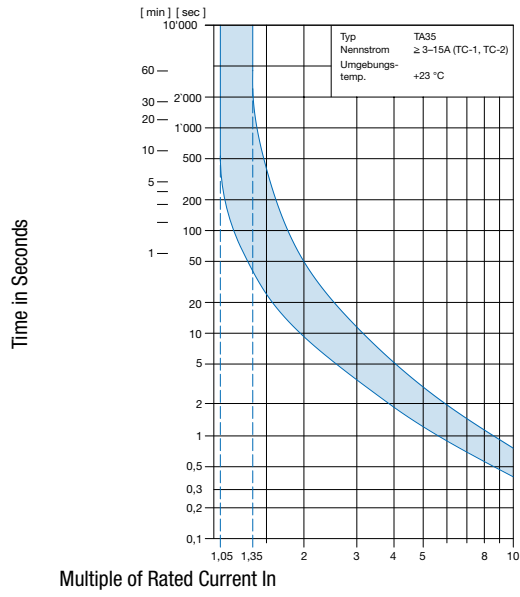

Multiple of Rated Current In

Reference Temperature +23°

Configuration Code

Type	Configuration Code TA35							
DG12	CBDWM100C0-000-C6135	X	X	X	X	X	X	0 0

Customer specific type

Color

- 0 Black
- 1 White

3)

Panel Mounting

- 00 Screw version A front mounting
- 01 Screw version B front mounting
- 10 Snap-in 1.0 mm
- 12 Snap-in 1.2 mm
- 15 Snap-in 1.5 mm
- 20 Snap-in 2.0 mm
- 25 Snap-in 2.5 mm
- 30 Snap-in 3.0 mm
- 88 Screw version front mounting (sealed towards housing, IP67)

1)

Terminal PE

- 0 Without (PCII)
- 1 QC 6.3x0.8 mm

Type of mains filter (inductance)

- 0 standard inductance
- 1 higher inductance

Type of mains filter (capacitor)

- 1 standard X2=100nF, Y2=2200pF
- 2 standard X2=220nF, Y2=2200pF
- 3 standard X1=47nF, Y1=2200pF
- 4 medical M5 X2=100nF
- 5 medical M5 X2=220nF
- 6 medical M5 X1=47nF
- 7 medical M80 X2=100nF, Y2=470pF
- 8 medical M80 X2=220nF, Y2=470pF
- 9 medical M80 X1=47nF, Y1=470pF

Type of mains filter (rated current)

- 1 1A
- 2 2A
- 3 3A
- 4 4A
- 5 6A
- 6 8A
- 7 10A
- 8 15A (UL), 10A (IEC), 10A (GB)

2)

Configuration Code TA35

See configuration code of TA35 rocker 2pole

2)

1)



Screw version A

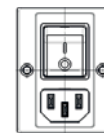

Screw version B

2)

The rated current of the line-filter must not be exceeded in the end application.

3)

Only on request (approvals pending)

**ORDER CODE**

**Table 1 Selection for type TA35**

Order example

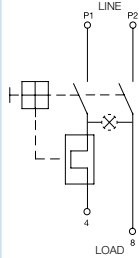
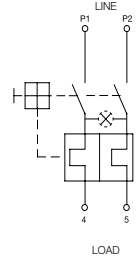
Number of switched poles Number of protected poles		2-pole	
		1	2
			
Switch	without illumination	<b>CBT</b>	<b>CBD</b>
Switch	illuminated 240 V 120 V	<b>C12</b> <b>C14</b>	<b>C32</b> <b>C34</b>

Other versions on request

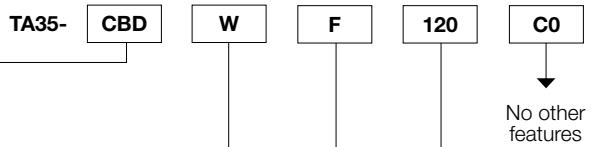





**Colours**

	Switch front	Rocker	
		non-illuminated	illuminated
<b>W</b>	black	white	–
<b>B</b>	black	black	–
<b>3</b>	black	–	red transparent
<b>4</b>	black	–	green transparent
<b>6</b>	black	–	orange transparent

Other colours on request

**Rocker legend**

	Surface	Illustration	Colour of print
<b>F</b>	embossed		–
<b>H</b>	printed		white
<b>K</b>	printed		black
<b>L</b>	printed		white
<b>M</b>	printed		black

Other legends on request

Position of the rocker legend e.g. 1 / O

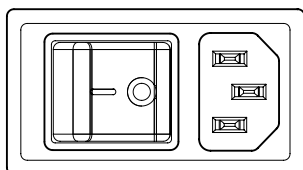

**Rated current  $I_n$  (A)**

$I_n$	Code	$I_n$	Code
1,0	<b>J10</b>	8,0	<b>080</b>
2,0	<b>J20</b>	10,0	<b>100</b>
4,0	<b>040</b>	12,0	<b>120*</b>
5,0	<b>050</b>	15,0	<b>150*</b>
6,0	<b>060</b>		

Other rated currents on request      \*) UL / CSA only



Variants

Circuit Breaker				Filter		Connector				Order Number
Rated Current [A]	Rocker colour	Illumination	TA35 Code	Rated Current [A]	Filter Type	Protection Class	Color	Mounting	IP-Protection	
1	black	non-illuminated	CBDLJ10C0	1	Standard Version	I	black	Screw-on A	IP40	3-108-854
10	white	non-illuminated	CBDWM100C0	10	Standard Version	I	black	Screw-on A	IP40	3-109-572
10	white	non-illuminated	CBDWM100C0	10	Standard Version	I	black	Snap-in 1.5	IP40	3-109-575
10	white	non-illuminated	CBDWM100C0	10	Standard Version	I	black	Screw B	IP40	3-109-698
10	white	non-illuminated	CBDWM100C0	10	Standard Version	I	black	Screw	IP67	3-118-974
15	white	non-illuminated	CBDWM150C0	15	Standard Version	I	black	Screw-on A	IP40	3-109-573
2	white	non-illuminated	CBDWMJ20C0	2	Standard Version	I	black	Screw-on A	IP40	3-109-557
3	white	non-illuminated	CBDWM030C0	3	Standard Version	I	black	Screw-on A	IP40	3-109-558
4	black	non-illuminated	CBDWF040C0	4	Standard Version	I	black	Screw-on A	IP40	3-109-559
6	white	non-illuminated	CBDWM060C0	6	Standard Version	I	black	Screw-on A	IP40	3-109-560
8	white	non-illuminated	CBDWM080C0	8	Standard Version	I	black	Screw-on A	IP40	3-109-561
10	white	non-illuminated	CBDWM100C0	10	Medical Version (M5)	I	black	Screw-on A	IP40	3-108-465
10	white	non-illuminated	CBDWM100C0	10	Medical Version (M5)	I	black	Screw B	IP40	3-118-982

Most Popular.

Availability for all products can be searched real-time: <https://www.schurter.com/en/Stock-Check/Stock-Check-SCHURTER>

Packaging unit 10 Pcs

Mating Outlets/Connectors

Category / Description

[Appliance Outlet Overview complete](#)



4787, Mounting: Screw-on mounting, Appliance Outlet: IEC Solder terminals, 10 A, Suitable for appliances with protection class I 4787

4788, Mounting: Snap-in version, Appliance Outlet: IEC Solder terminals or quick connect terminals, 10 A, Suitable for appliances with protection class I 4788

IEC Appliance Outlet F or H, Screw-on Mounting, Front Side, Solder, PCB or Quick-connect Terminal 5091

[Appliance Outlet further types to DG12](#)

[Connector Overview complete](#)



4782 Mounting: Power Cord, 3 x 1 mm<sup>2</sup> / 3 x 18 AWG, Cable, Connector: IEC C13 4782

4785 Mounting: Power Cord, 3 x 1 mm<sup>2</sup> / 3 x 18 AWG, Cable, Connector: IEC C13 4785

4300-06 Mounting: Power Cord, 3 x 1 mm<sup>2</sup> / 3 x 18 AWG, Cable, Connector: IEC C13 4300-06

4781 Mounting: Power Cord, 3 x 1 mm<sup>2</sup> / 3 x 18 AWG, Cable, Connector: IEC C15 4781

4784 Mounting: Power Cord, 3 x 1 mm<sup>2</sup> / 3 x 18 AWG, Cable, Connector: IEC C15 4784

[Connector further types to DG12](#) ...

### Mating Outlets/Connectors shuttered



[Power Cord Overview complete](#)

VAC13KS, Overview, V-Lock cord retaining, diverse Connector IEC C13, diverse, black

VAC13KS

[Power Cord further types to DG12](#)

---