

Heavy duty wirewound potentiometers

Series 30 W

Type 30 W

Ordering code no.: 31 211

Basic design: high load, nominal width 46 mm, solder tag terminals

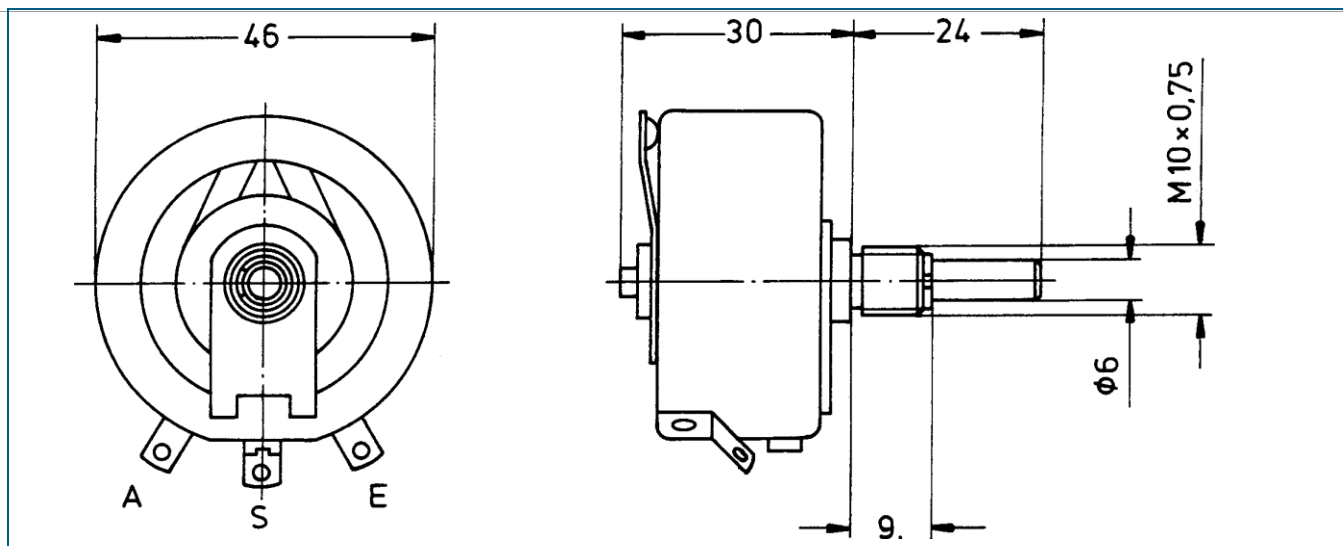
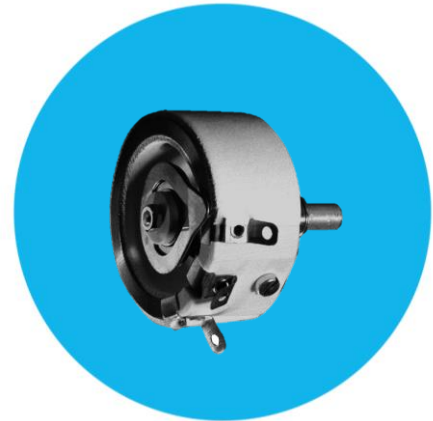

Technical data

Rated resistance range	4.7 Ω - 4.7 kΩ *	Isolation voltage	2000 V eff
Resistance tolerance	± 10 %, (5 %, 2 %)	Electrical travel	270°
Law (resistance taper)	lin, lg on request	Mechanical travel	287°
Rated dissipation	30 W / 40 °C	Weight	approx. 70 g / piece

*higher values on request