

●Application

- Motor drive
- Inverter, Converter
- Photovoltaics, wind power generation.
- Induction heating equipment.

●Features

- 1) Low surge, low switching loss.
- 2) High-speed switching possible.
- 3) Reduced temperature dependence.

●Construction

This product is a half bridge module consisting of SiC-DMOS and SiC SBD from ROHM.

●Dimensions & Pin layout (Unit : mm)

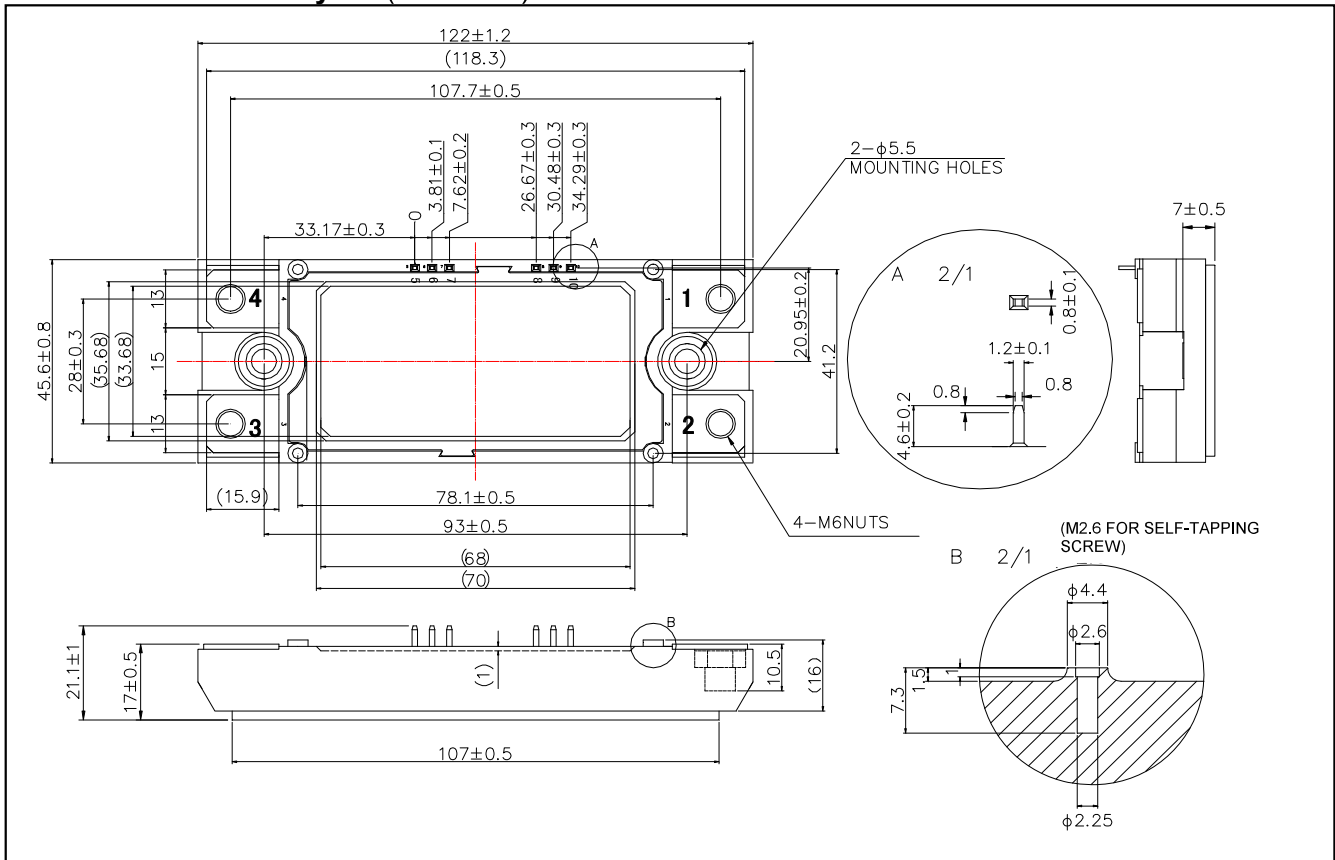

●Circuit diagram

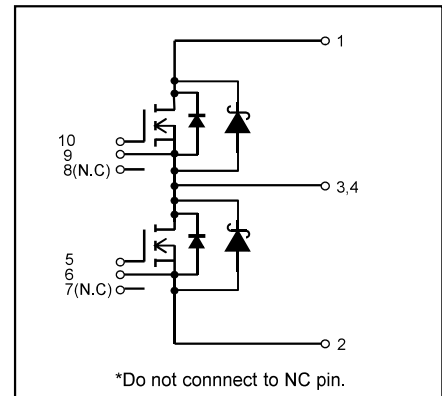

●Absolute maximum ratings (T_j = 25°C)

Parameter	Symbol	Conditions	Limit	Unit
Drain-source voltage	V _{DSS}	G-S short	1200	V
Gate-source voltage(+)	V _{GSS}	D-S short	22	
Gate-source voltage(-)			-6	
G - S voltage (t _{surge} <300nsec)	V _{GSSsurge}	D-S short	-10 to 26	
Drain current *1	I _D	DC(T _c =60°C)	80	A
	I _{DRM}	Pulse (T _c =60°C) 1ms *2	160	
Source current *1	I _S	DC(T _c = 60°C) V _{GS} =18V	80	
	I _{SRM}	Pulse (T _c =60°C) 1ms V _{GS} =18V	160	
Total power dissipation *3	P _{tot}	T _c =25°C	600	W
Max junction temperature	T _{jmax}		175	°C
Junction temperature	T _{jop}		-40 to 150	
Storage temperature	T _{stg}		-40 to 125	
Isolation voltage	Visol	Terminals to baseplate, f=60Hz AC 1min.	2500	Vrms
Mounting torque	-	Main Terminals : M6 screw	4.5	N · m
		Mounting to heat shink : M5 screw	3.5	

(*1) Case temperature (T_c) is defined on the surface of base plate just under the chips.

(*2) Repetition rate should be kept within the range where temperature rise if die should not exceed T_{jmax}.

(*3) T_j is less than 175°C

Example of acceptable V_{GS} waveform

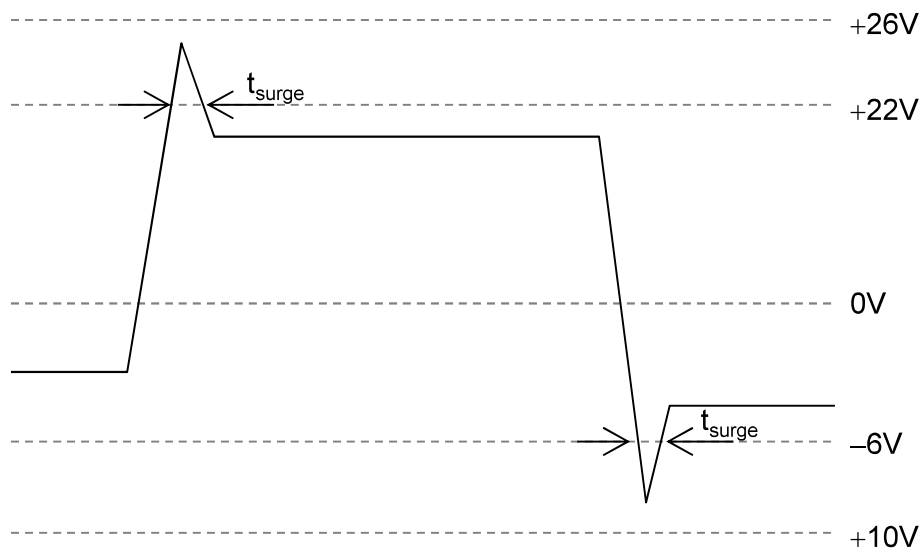

● **Electrical characteristics** (T_j=25°C)

Parameter	Symbol	Conditions	Min.	Typ.	Max.	Unit	
On-state static Drain-Source Voltage	V _{DS(on)}	I _D =80A, V _{GS} =18V	T _j =25°C	–	2.8	3.5	V
			T _j =125°C	–	4.2	–	
			T _j =150°C	–	4.8	5.5	
Drain cutoff current	I _{DSS}	V _{DS} =1200V, V _{GS} =0V	–	–	1.2	mA	
Source-drain voltage	V _{SD}	V _{GS} =0V, I _S =80A	T _j =25°C	–	1.7	2.0	V
			T _j =125°C	–	2.1	–	
			T _j =150°C	–	2.3	3.3	
		V _{GS} =18V, I _S =80A	T _j =25°C	–	1.4	–	
			T _j =125°C	–	1.7	–	
			T _j =150°C	–	1.8	–	
Gate-source threshold voltage	V _{GS(th)}	V _{DS} =10V, I _D =13.2mA	1.6	–	4	V	
Gate-source leak current	I _{GSS}	V _{GS} =22V, V _{DS} =0V	–	–	0.5	μA	
		V _{GS} = –6V, V _{DS} =0V	–0.5	–	–		
Switching characteristics	t _{d(on)}	V _{GS(on)} =18V, V _{GS(off)} =0V	–	20	–	ns	
	t _r	V _{DS} =600V	–	30	–		
	t _{rr}	I _D =80A	–	35	–		
	t _{d(off)}	R _G =0.82Ω	–	80	–		
	t _f	inductive load	–	40	–		
Input capacitance	C _{iss}	V _{DS} =10V, V _{GS} =0V, f=1MHz	–	8	–	nF	
Gate Resistance	R _{Gint}	T _j =25°C	–	3.0	–	Ω	
Stray Inductance	L _s		–	25	–	nH	
Creepage distance	–	Terminal to heat sink	–	11.5	–	mm	
		Terminal to terminal	–	19.0	–	mm	
Clearance distance	–	Terminal to heat sink	–	9.5	–	mm	
		Terminal to terminal	–	13.0	–	mm	
Junction-to-case thermal resistance	R _{th(j-c)}	DMOSFET (1/2 module) * ⁵	–	–	0.25	°C/W	
		SBD (1/2 module) * ⁵	–	–	0.32		
Case-to-heat sink Thermal resistance	R _{th(c-f)}	Case to heat sink, per 1 module, Thermal grease applied * ⁶	–	0.035	–		

(*4) In order to prevent self turn-on, it is recommended to apply negative gate bias.

(*5) Measurement of T_c is to be done at the point just under the chip.

(*6) Typical value is measured by using thermally
conductive grease of λ=0.9W/(m · K).

(*7) SiC devices have lower short circuit
withstand capability due to high current density.
Please be advised to pay careful attention
to short circuit accident and try to
adjust protection time to shutdown them
as short as possible.

(*8) If the Product is used beyond absolute maximum
ratings defined in the Specifications, as its internal
structure may be damaged, please replace
such Product with a new one.

<Wavelength for Switching Test>

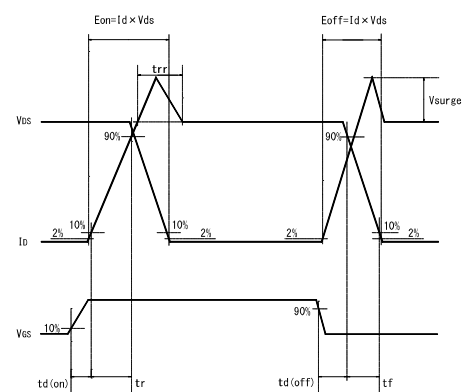

●Electrical characteristic curves (Typical)

Fig.1 Typical Output Characteristics
[$T_j=25^\circ\text{C}$]

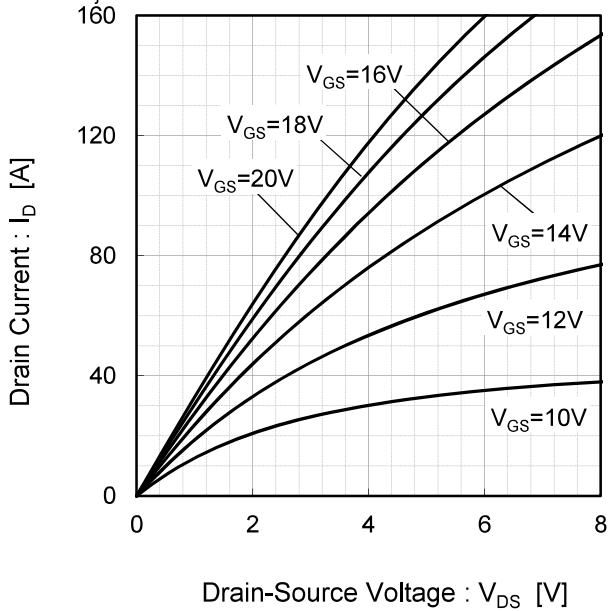

Fig.2 Drain-Source Voltage vs. Drain Current

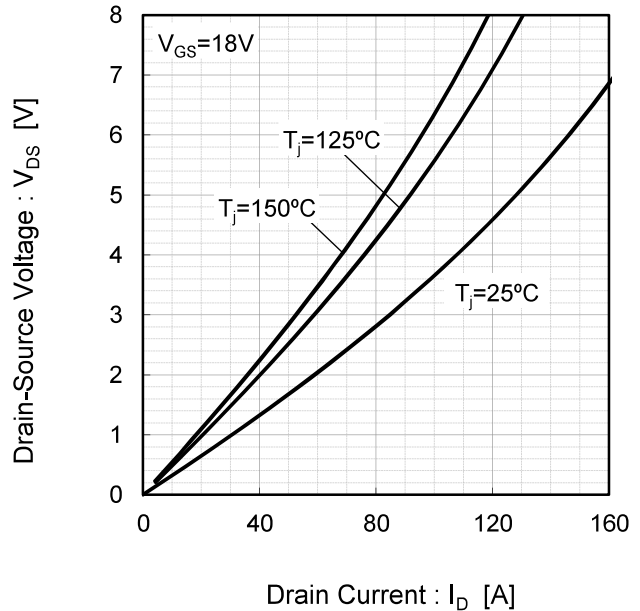

Fig.3 Drain-Source Voltage vs. Gate-Source Voltage
[$T_j=25^\circ\text{C}$]

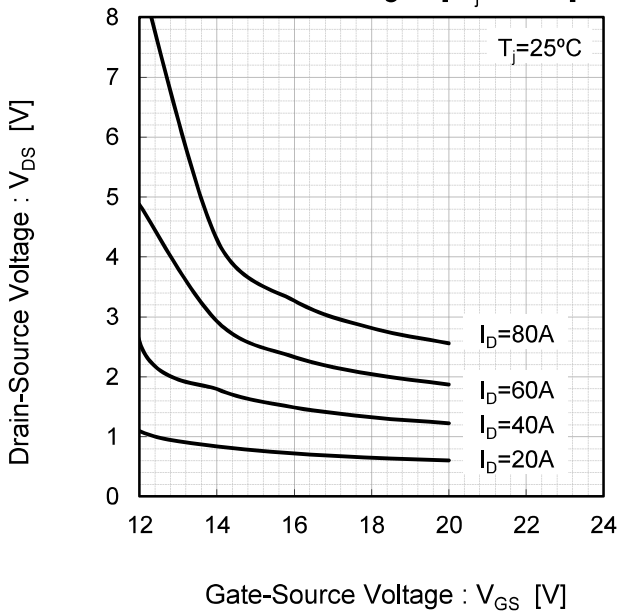
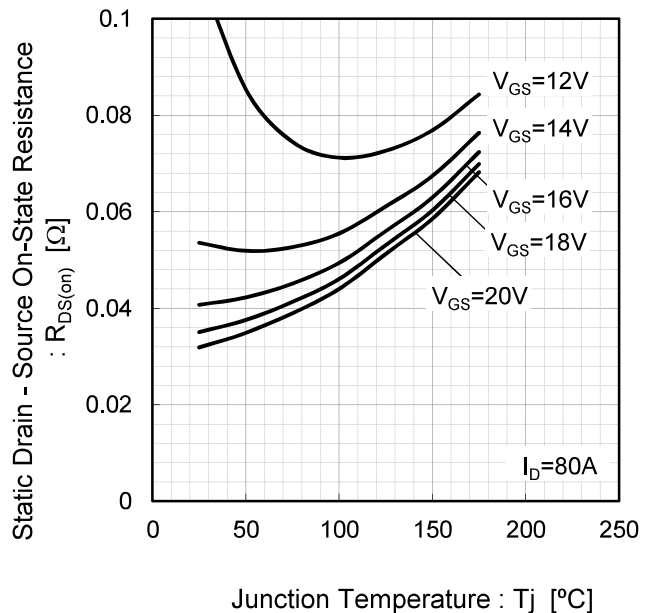

Fig.4 Static Drain - Source On-State Resistance vs. Junction Temperature



●Electrical characteristic curves (Typical)

Fig.5 Forward characteristic of Diode

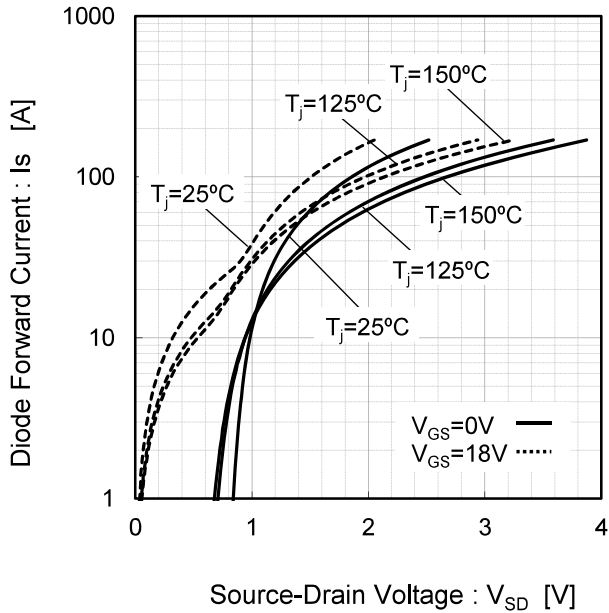

Fig.6 Forward characteristic of Diode

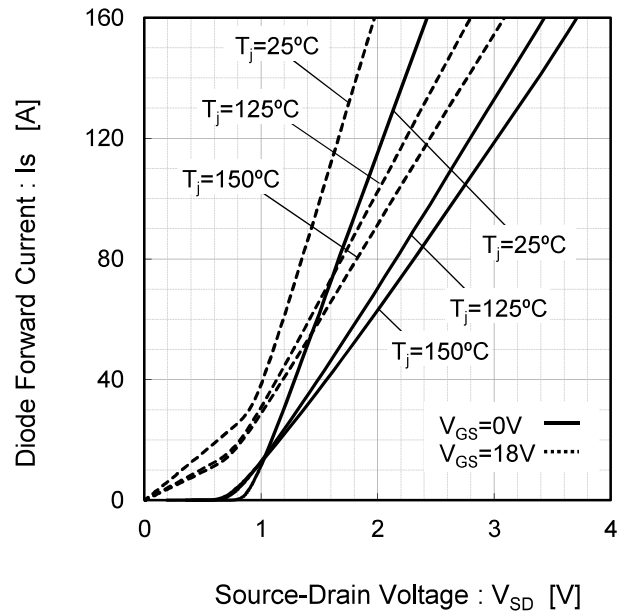

Fig.7 Drain Current vs. Gate-Source Voltage

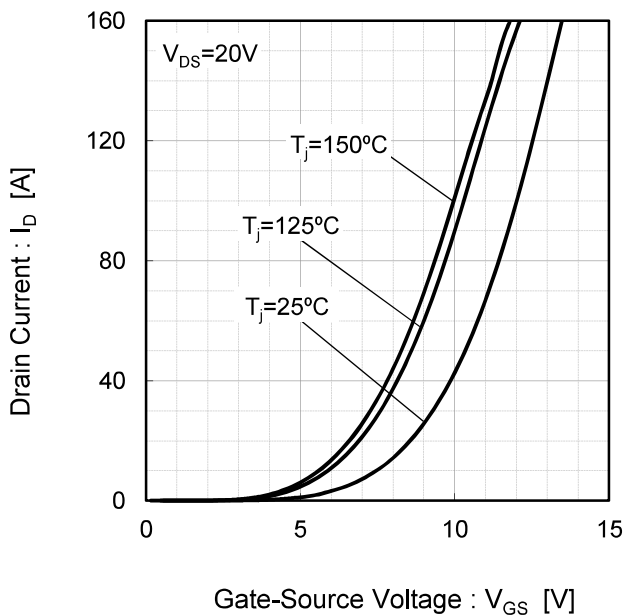
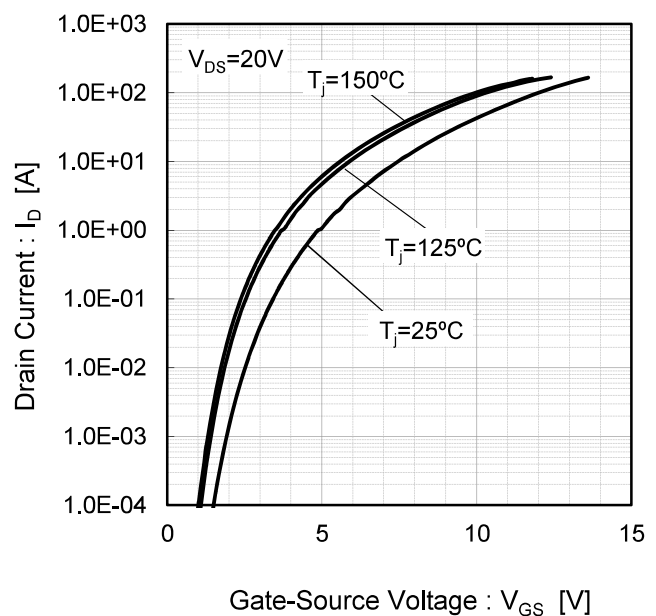

Fig.8 Drain Current vs. Gate-Source Voltage



●Electrical characteristic curves (Typical)

Fig.9 Switching Characteristics [$T_j=25^\circ\text{C}$]

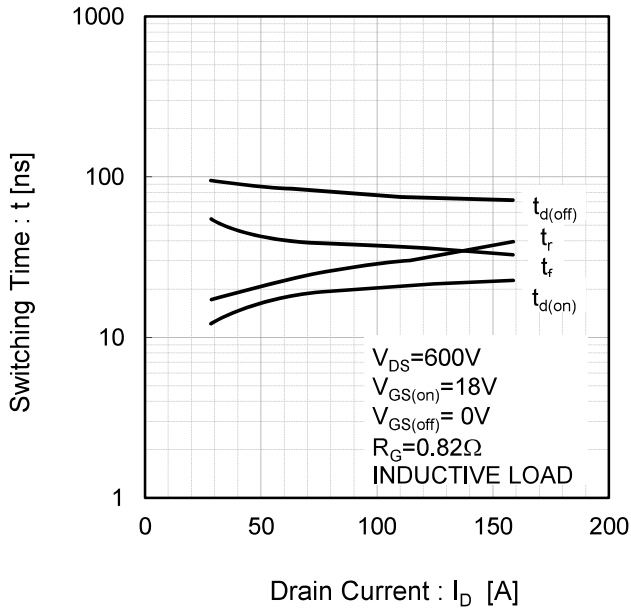

Fig.10 Switching Characteristics [$T_j=125^\circ\text{C}$]

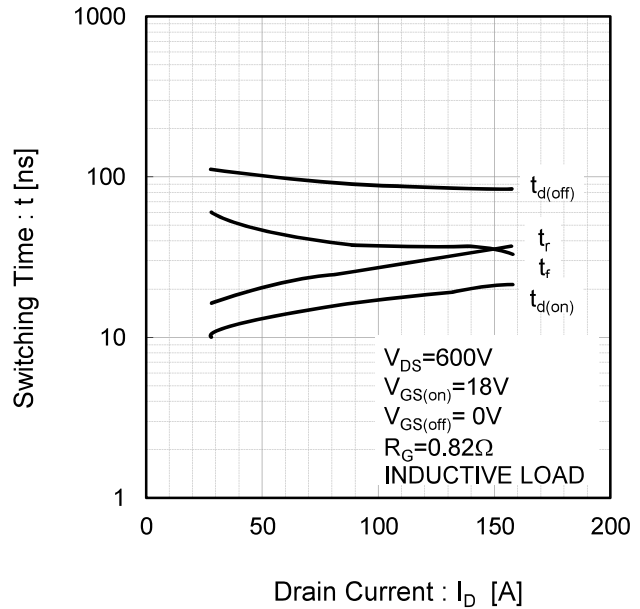

Fig.11 Switching Characteristics [$T_j=150^\circ\text{C}$]

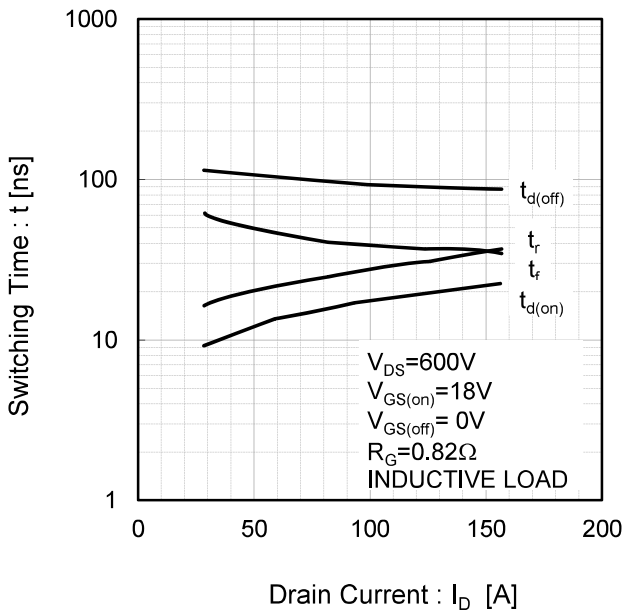
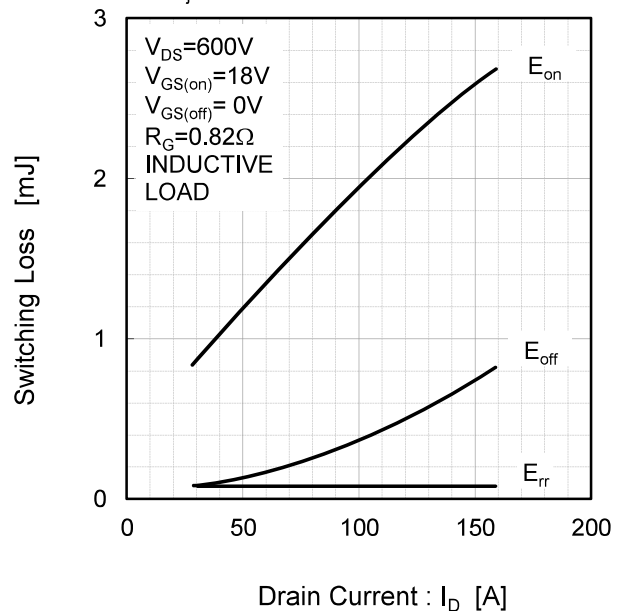

Fig.12 Switching Loss vs. Drain Current [$T_j=25^\circ\text{C}$]



●Electrical characteristic curves (Typical)

Fig.13 Switching Loss vs. Drain Current [$T_j=125^\circ\text{C}$]

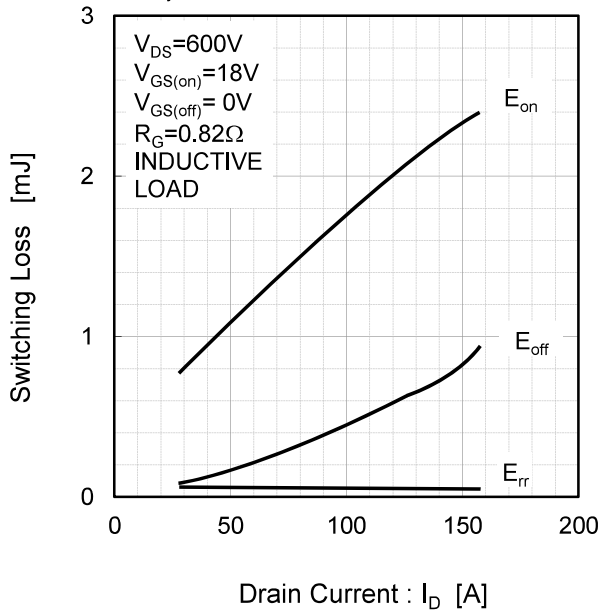

Fig.14 Switching Loss vs. Drain Current [$T_j=150^\circ\text{C}$]

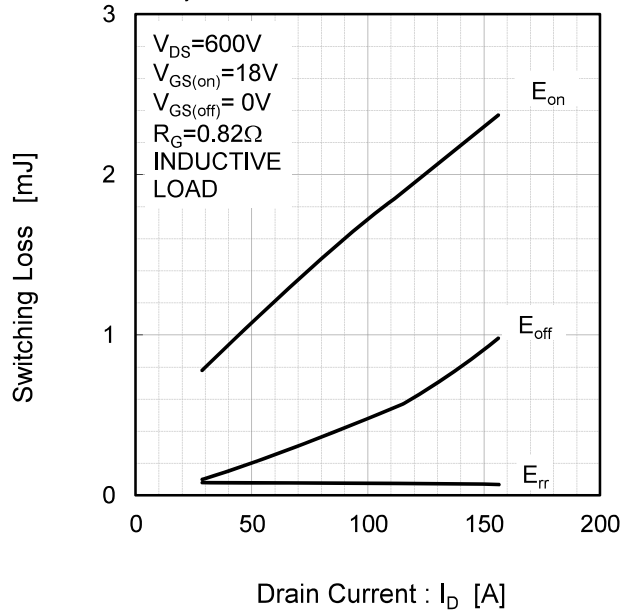

Fig.15 Recovery Characteristics vs. Drain Current [$T_j=25^\circ\text{C}$]

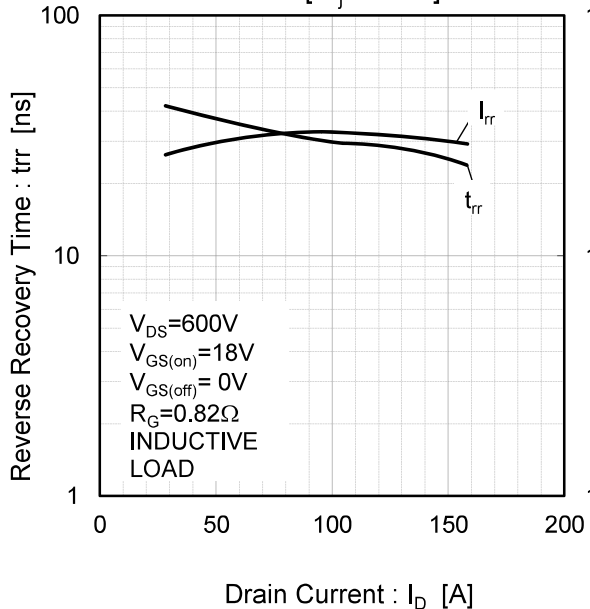
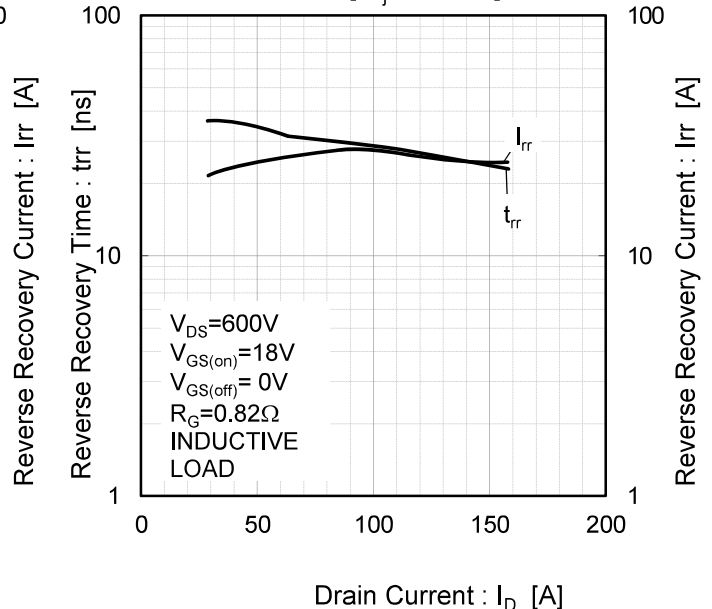

Fig.16 Recovery Characteristics vs. Drain Current [$T_j=125^\circ\text{C}$]



●Electrical characteristic curves (Typical)

Fig.17 Recovery Characteristics vs. Drain Current [$T_j=150^{\circ}\text{C}$]

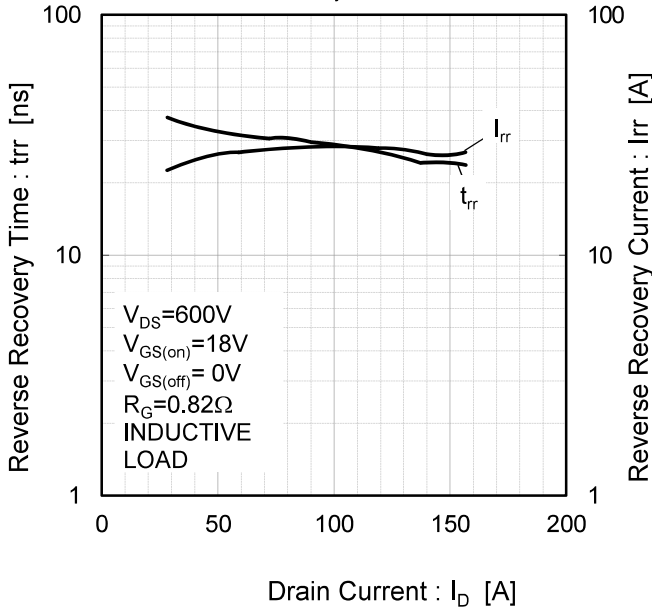

Fig.18 Switching Characteristics vs. Gate Resistance [$T_j=25^{\circ}\text{C}$]

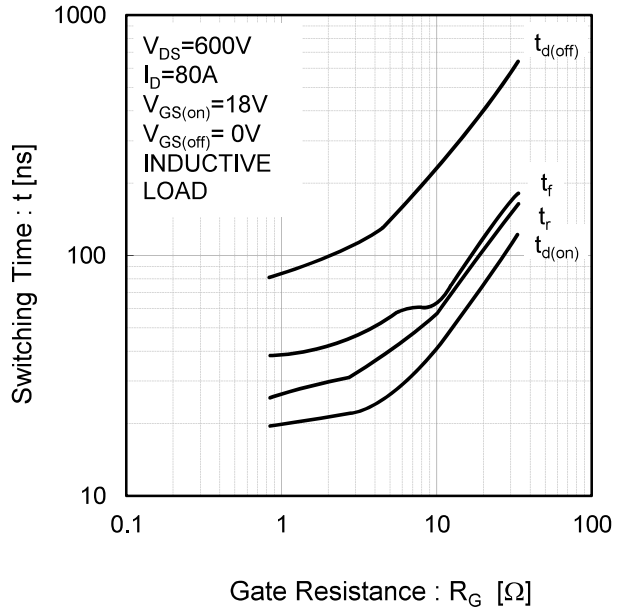

Fig.19 Switching Characteristics vs. Gate Resistance [$T_j=125^{\circ}\text{C}$]

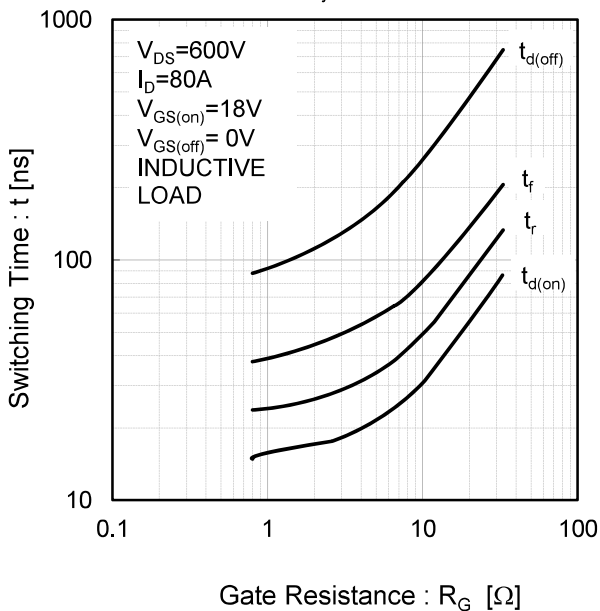
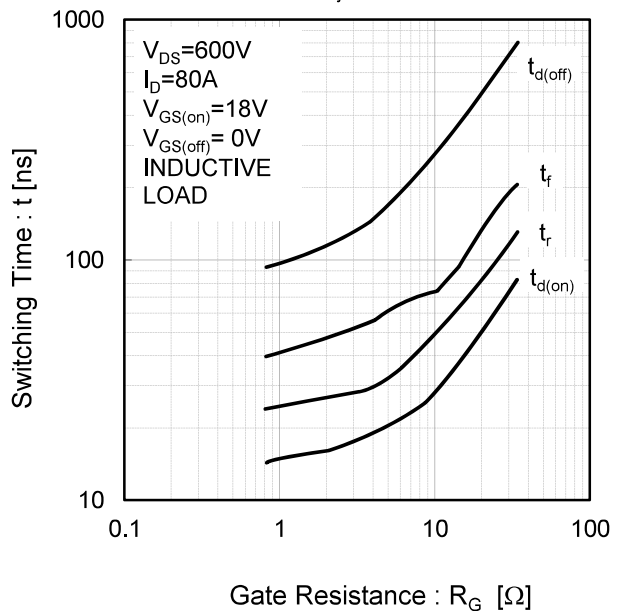

Fig.20 Switching Characteristics vs. Gate Resistance [$T_j=150^{\circ}\text{C}$]



●Electrical characteristic curves (Typical)

Fig.21 Switching Loss vs. Gate Resistance [$T_j=25^\circ\text{C}$]

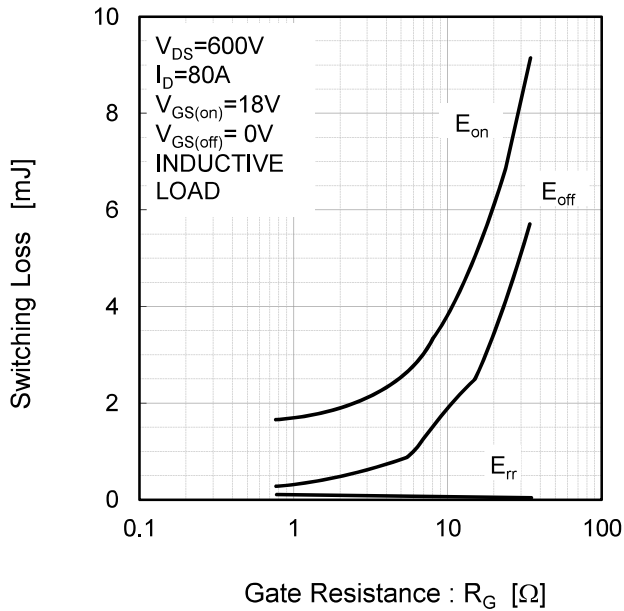

Fig.22 Switching Loss vs. Gate Resistance [$T_j=125^\circ\text{C}$]

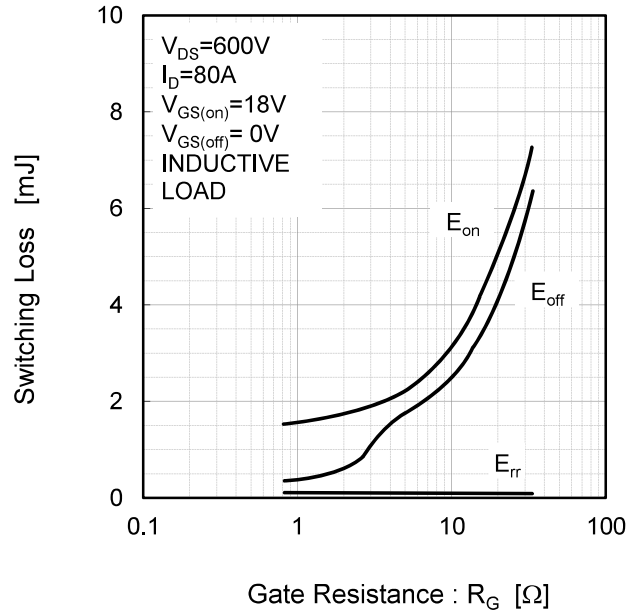
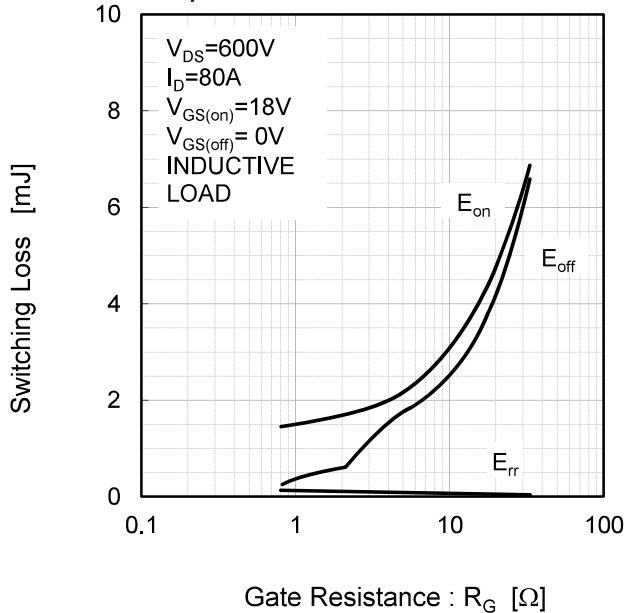

Fig.23 Switching Loss vs. Gate Resistance [$T_j=150^\circ\text{C}$]



●Electrical characteristic curves (Typical)

Fig.24 Typical Capacitance vs. Drain-Source Voltage

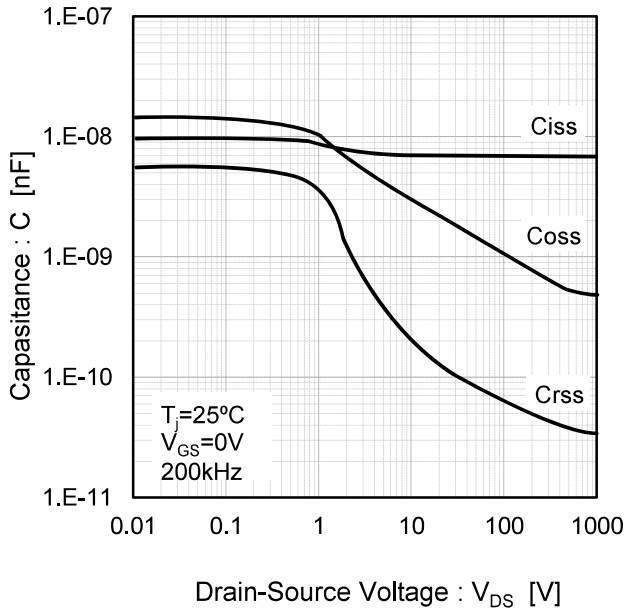

Fig.25 Gate Charge Characteristics [Tj=25°C]

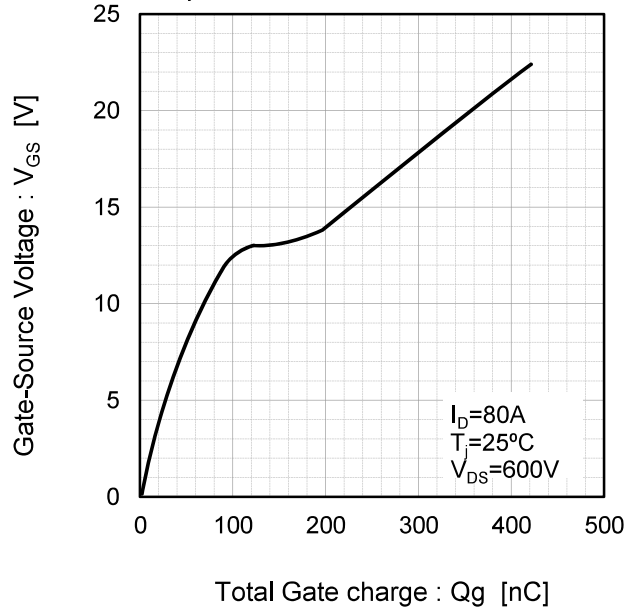

Fig.26 Normalized Transient Thermal Impedance

