

DISPLAY Elektronik GmbH

DATA SHEET

LCD MODULE

DEM 16213 SYH

Product Specification

Version : 1.1.1

09/Apr/2009

GENERAL SPECIFICATION

MODULE NO. :

DEM 16213 SYH

CUSTOMER P/N

Version No.	Change Description	Date
0	ORIGINAL VERSION	08.03.2001
1	PCB CHANGED	04.04.2003
1.1.0	CHANGE IC	04.01.2008
1.1.1	IMPROVE DRAWING	09.04.2009

PREPARED BY: HCL

DATE: 09.04.2009

APPROVED BY: MH

DATE: 09.04.2009

CONTENTS

1.FUNCTIONS & FEATURES2

2. MECHANICAL SPECIFICATIONS.....2

3. EXTERNAL DIMENSIONS.....3

4. BLOCK DIAGRAM.....4

5. PIN ASSIGNMENT.....4

6.1 PCB DRAWING AND DESCRIPTION5

6.2 EXAMPLE APPLICATION5

7. MAXIMUM ABSOLUTE POWER RATINGS5

8. ELECTRICAL CHARACTERISTICS6

9. DISPLAY DATA RAM (DDRAM)7

10. INSTRUCTION TABLE8

11. INITIALIZING BY INSTRUCTION9

12. CHARACTER GENERATOR ROM (ST7066-0A)..... 11

13. LCD MODULES HANDLING PRECAUTIONS..... 12

14. OTHERS..... 12

1. FUNCTIONS & FEATURES

MODULE NAME	LCD Type
DEM 16213 SYH	STN Yellow-Green Reflective Positive Mode

- Viewing Direction : 6 o'clock
- Driving Scheme : 1/16 Duty Cycle, 1/5 Bias
- Power Supply Voltage : 5.0 Volt (typ.)
- V_{LCD} Adjustable For Best Contrast : 4.5 Volt (typ.)
- Display Format : 16 x 2 Characters
- Internal Memory : CGROM (13,200 bits)
: CGRAM (64 x 8 bits)
: DDRAM (80 x 8 bits)
- Interface : Easy Interface with a 4-bit or 8-bit MPU
- Operating Temperature : -20°C to +70°C
- Storage Temperature : -30°C to +80°C

2. MECHANICAL SPECIFICATIONS

- Module Size : 80.00 x 36.00 x 9.00 mm
- Character Pitch : 3.65 x 5.05 mm
- Character Size : 2.95 x 4.35 mm
- Character Font : 5 x 8 dots
- Dot Size : 0.55 x 0.50 mm
- Dot Pitch : 0.60 x 0.55 mm

3. EXTERNAL DIMENSIONS

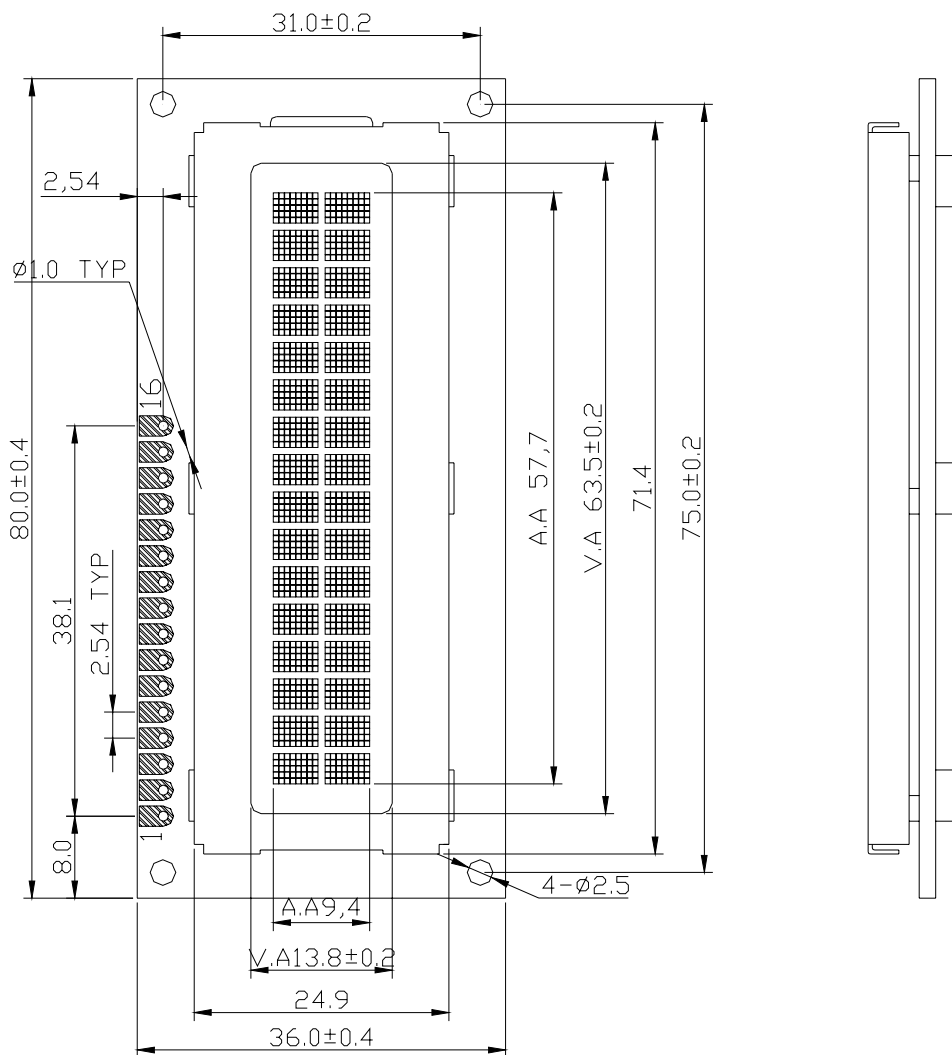
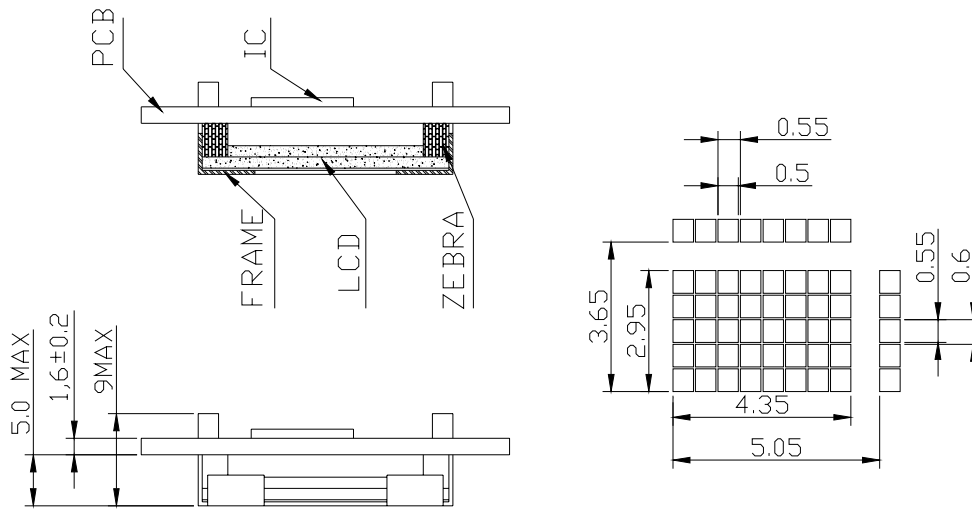

Remarks:
 1, Unmarked tolerance is ±0.3,
 2, The material comply with RoHS.

4. BLOCK DIAGRAM

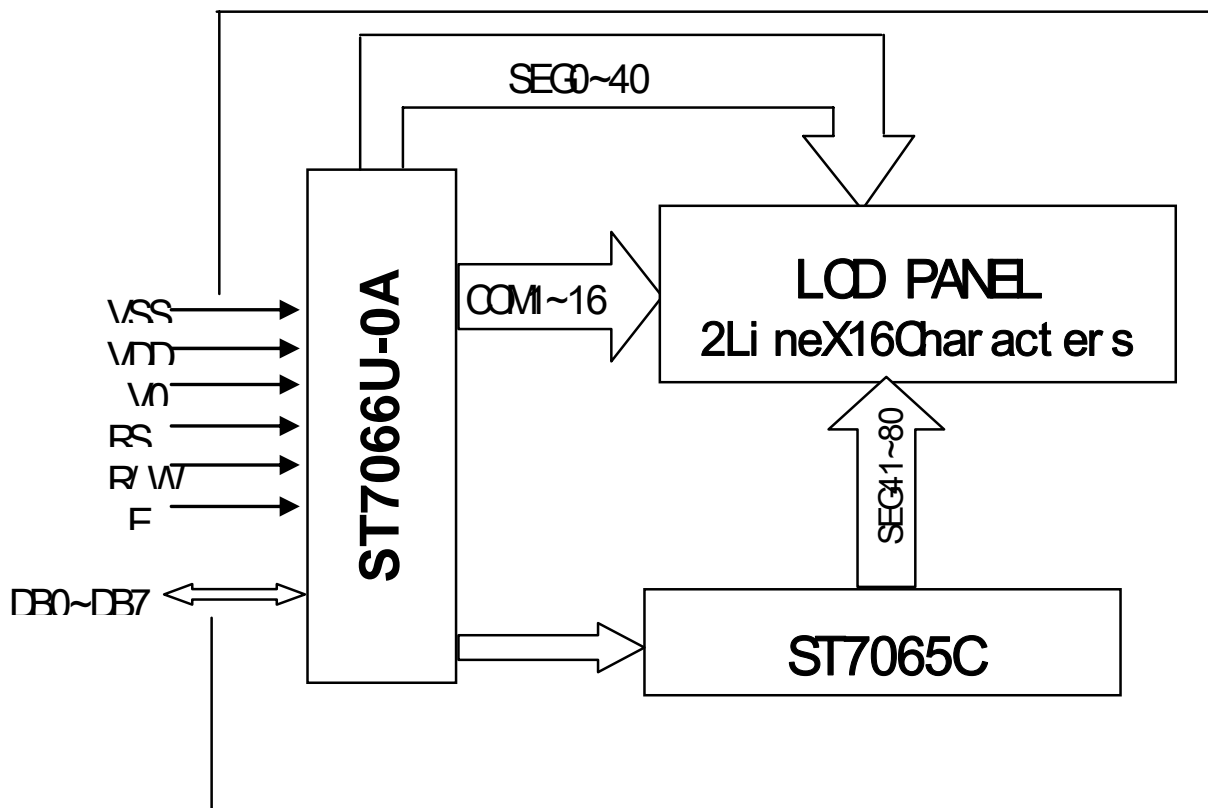

5. PIN ASSIGNMENT

Pin No.	Symbol	Function
1	VSS	Ground terminal of module.
2	VDD	Supply terminal of module 5.0V.
3	V0	Power Supply for liquid crystal drive.
4	RS	Register select RS = 0...Instruction register RS = 1...Data register
5	R/W	Read /Write R/W = 1...Read R/W = 0...Write
6	E	Enable
7	DB0	Bi-directional data bus, data transfer is performed once, thru DB0 to DB7, in the case of interface data. Length is 8-bits; and twice, thru DB4 to DB7 in the case of interface data length is 4-bits. Upper four bits first then lower four bits.
8	DB1	
9	DB2	
10	DB3	
11	DB4	
12	DB5	
13	DB6	
14	DB7	
15	NC	No Connect
16	NC	

6.1 PCB DRAWING AND DESCRIPTION

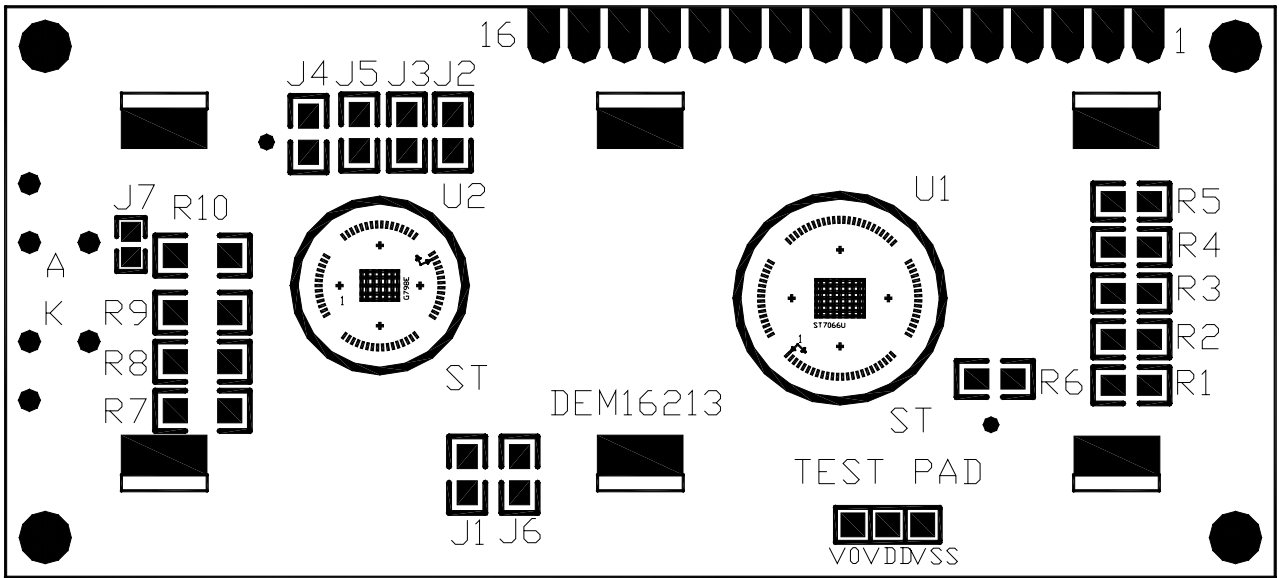

DESCRIPTION:

6-1-1. The polarity of the pin 15 and the pin 16:

Note: In application module, J2=J3=J4=J5=open.

6-1-2. The J1 is metal-bezel GND to module GND and J6 is mounting holes GND to module GND.

Note: In application module, J1= J6=0 ohm.

6.2 Example application

6-2-1. The metal-bezel is on ground as following.

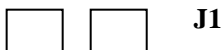

6-2-2. The mounting hole is on ground as following.

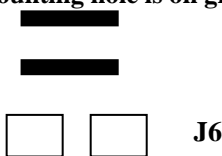

7. MAXIMUM ABSOLUTE POWER RATINGS

Item	Symbol	Standard Value	Unit
Power supply voltage(1)	V _{DD}	-0.3~+7.0	V
Power supply voltage(2)	V _{LCD}	V _{DD} -10.0~V _{DD} +0.3	V
Input voltage	V _{IN}	-0.3~V _{DD} +0.3	V
Operating temperature	T _{opr}	-20~+70	°C
Storage temperature	T _{stg}	-30~+80	°C

8. ELECTRICAL CHARACTERISTICS

8-1 DC Characteristics ($V_{DD}=5V, T_a=25^{\circ}C$)

Item	Symbol	Standard Value			Test Condition	Unit
		Min	Typ	Max		
Operating Voltage	V_{DD}	4.7	5.0	5.3	-----	V
Supply Current	I_{DD1}	----	TBD	1.0	Ceramic oscillation $f_{osc}=250kHz$	mA
	I_{DD2}	----	TBD	0.6	Resistor oscillation external clock operation $f_{osc}=270kHz$	
LCD Driving Voltage	V_{LCD}	4.2	4.5	4.8	$V_{DD}-V_0$	V

8-2 AC Characteristics

Symbol	Characteristics	Test Condition	Min.	Typ.	Max.	Unit
<i>Write Mode (Writing data from MPU to ST7066U)</i>						
T_C	Enable Cycle Time	Pin E	1200	-	-	ns
T_{PW}	Enable Pulse Width	Pin E	140	-	-	ns
T_{R,T_F}	Enable Rise/Fall Time	Pin E	-	-	25	ns
T_{AS}	Address Setup Time	Pins: RS,RW,E	0	-	-	ns
T_{AH}	Address Hold Time	Pins: RS,RW,E	10	-	-	ns
T_{DSW}	Data Setup Time	Pins: DB0 - DB7	40	-	-	ns
T_H	Data Hold Time	Pins: DB0 - DB7	10	-	-	ns
<i>Read Mode (Reading Data from ST7066U to MPU)</i>						
T_C	Enable Cycle Time	Pin E	1200	-	-	ns
T_{PW}	Enable Pulse Width	Pin E	140	-	-	ns
T_{R,T_F}	Enable Rise/Fall Time	Pin E	-	-	25	ns
T_{AS}	Address Setup Time	Pins: RS,RW,E	0	-	-	ns
T_{AH}	Address Hold Time	Pins: RS,RW,E	10	-	-	ns
T_{DDR}	Data Setup Time	Pins: DB0 - DB7	-	-	100	ns
T_H	Data Hold Time	Pins: DB0 - DB7	10	-	-	ns
<i>Interface Mode with LCD Driver(ST7065)</i>						
T_{CWH}	Clock Pulse with High	Pins: CL1, CL2	800	-	-	ns
T_{CWL}	Clock Pulse with Low	Pins: CL1, CL2	800	-	-	ns
T_{CST}	Clock Setup Time	Pins: CL1, CL2	500	-	-	ns
T_{SU}	Data Setup Time	Pin: D	300	-	-	ns
T_{DH}	Data Hold Time	Pin: D	300	-	-	ns
T_{DM}	M Delay Time	Pin: M	0	-	2000	ns

● Writing data from MPU to ST7066U

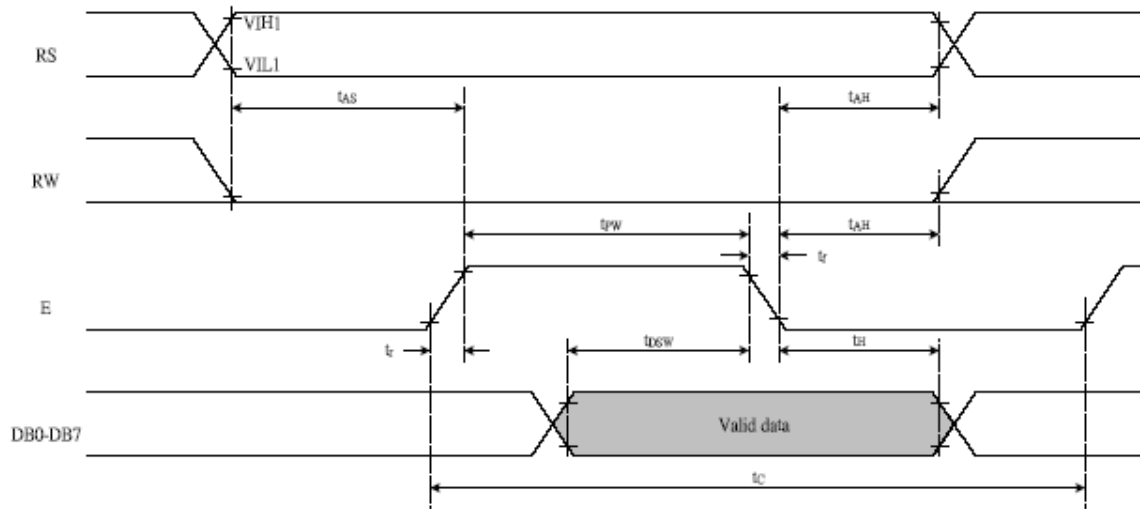

● Reading data from ST7066U to MPU

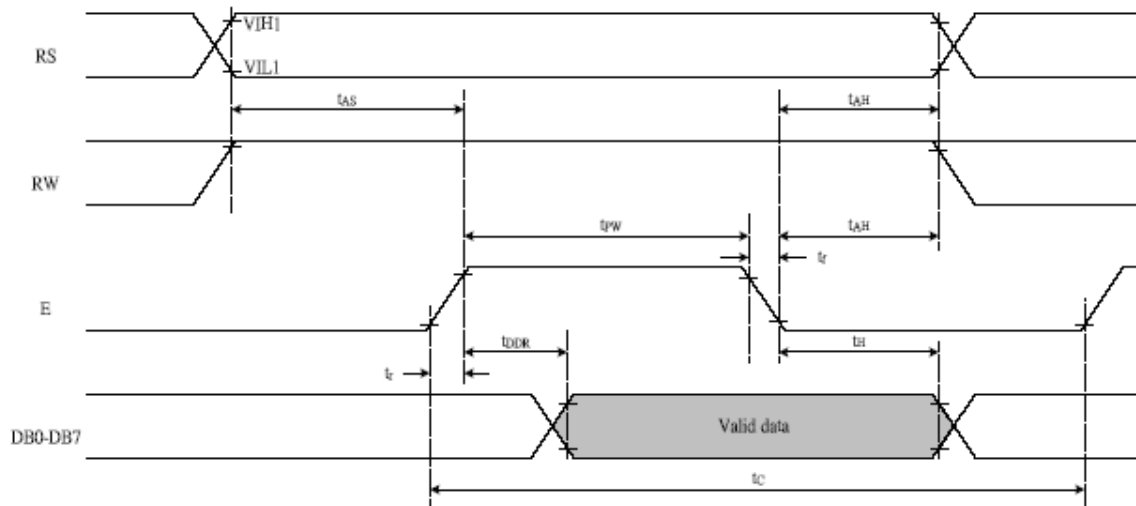

9. DISPLAY DATA RAM (DDRAM)

Display	1	2	3	4	5	6	7	8	9	10	11	12	13	14	15	16
Position	00	01	02	03	04	05	06	07	08	09	0A	0B	0C	0D	0E	0F
DDRAM Address	40	41	42	43	44	45	46	47	48	49	4A	4B	4C	4D	4E	4F

For Shift Left	01	02	03	04	05	06	07	08	09	0A	0B	0C	0D	0E	0F	10
	41	42	43	44	45	46	47	48	49	4A	4B	4C	4D	4E	4F	50

For Shift Right	27	00	01	02	03	04	05	06	07	08	09	0A	0B	0C	0D	0E
	67	40	41	42	43	44	45	46	47	48	49	4A	4B	4C	4D	4E

10. INSTRUCTION TABLE

Instruction	Instruction Code										Description	Description Time (270KHz)	
	RS	R/W	DB7	DB6	DB5	DB4	DB3	DB2	DB1	DB0			
Clear Display	0	0	0	0	0	0	0	0	0	0	1	Write "20H" to DDRAM. and set DDRAM address to "00H" from AC	1.52 ms
Return Home	0	0	0	0	0	0	0	0	0	1	x	Set DDRAM address to "00H" from AC and return cursor to its original position if shifted. The contents of DDRAM are not changed.	1.52 ms
Entry Mode Set	0	0	0	0	0	0	0	0	1	I/D	S	Sets cursor move direction and specifies display shift. These operations are performed during data write and read.	37 us
Display ON/OFF	0	0	0	0	0	0	0	1	D	C	B	D=1:entire display on C=1:cursor on B=1:cursor position on	37 us
Cursor or Display Shift	0	0	0	0	0	0	1	S/C	R/L	x	x	Set cursor moving and display shift control bit, and the direction, without changing DDRAM data.	37 us
Function Set	0	0	0	0	0	1	DL	N	F	x	x	DL:interface data is 8/4 bits N:number of line is 2/1 F.font size is 5x11/5x8	37 us
Set CGRAM address	0	0	0	1	AC5	AC4	AC3	AC2	AC1	AC0		Set CGRAM address in address counter	37 us
Set DDRAM address	0	0	1	AC6	AC5	AC4	AC3	AC2	AC1	AC0		Set DDRAM address in address counter	37 us
Read Busy flag and address	0	1	BF	AC6	AC5	AC4	AC3	AC2	AC1	AC0		Whether during internal operation or not can be known by reading BF. The contents of address counter can also be read.	0 us
Write data to RAM	1	0	D7	D6	D5	D4	D3	D2	D1	D0		Write data into internal RAM (DDRAM/CGRAM)	37 us
Read data from RAM	1	1	D7	D6	D5	D4	D3	D2	D1	D0		Read data from internal RAM (DDRAM/CGRAM)	37 us

Note:

Be sure the ST7066U is not in the busy state (BF = 0) before sending an instruction from the MPU to the ST7066U. If an instruction is sent without checking the busy flag, the time between the first instruction and next instruction will take much longer than the instruction time itself. Refer to Instruction Table for the list of each instruction execution time.

11. INITIALIZING BY INSTRUCTION

11-1. 8-bit interface mode (fosc=270 kHz)

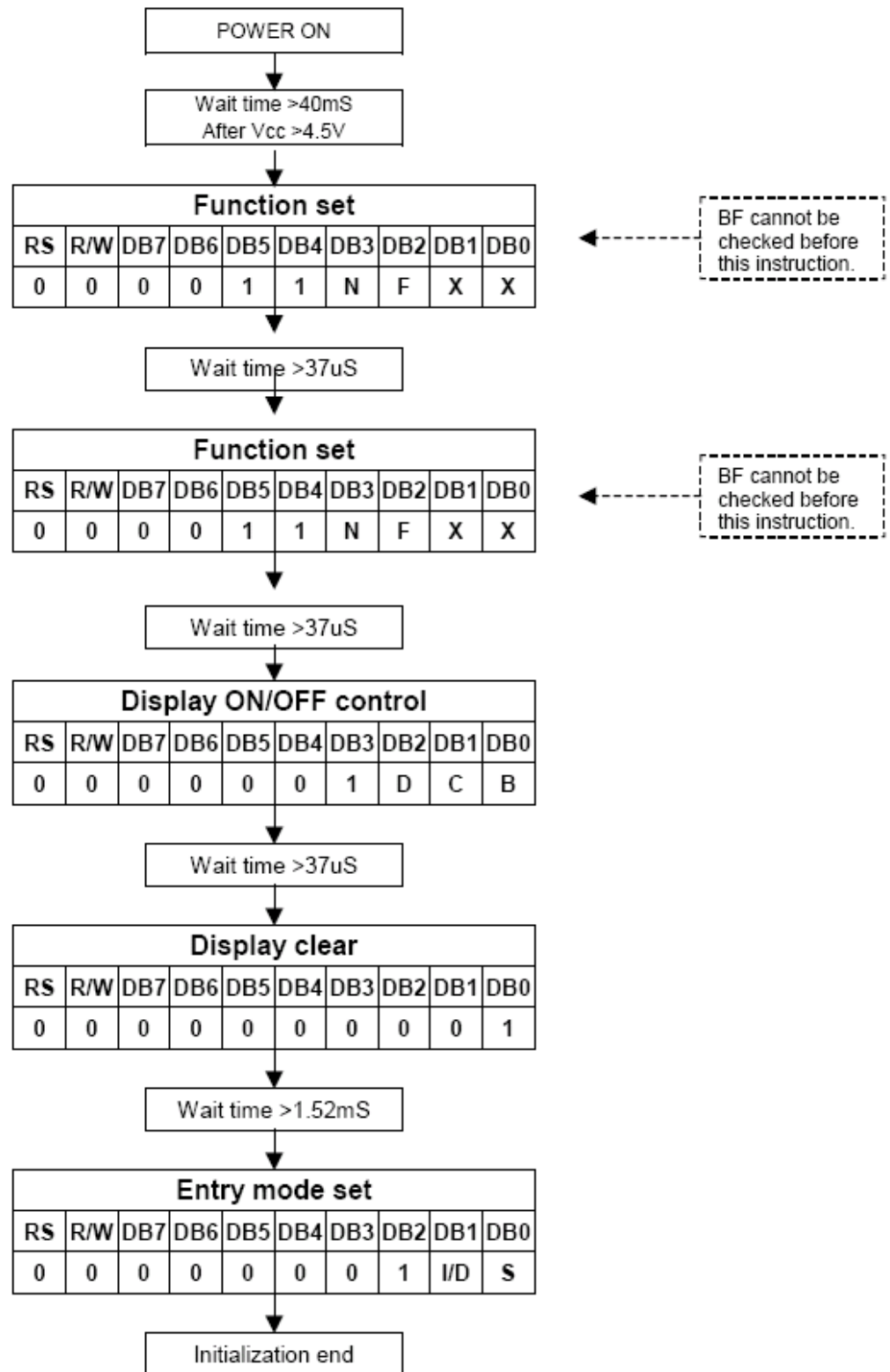

11-2. 4-bit interface mode

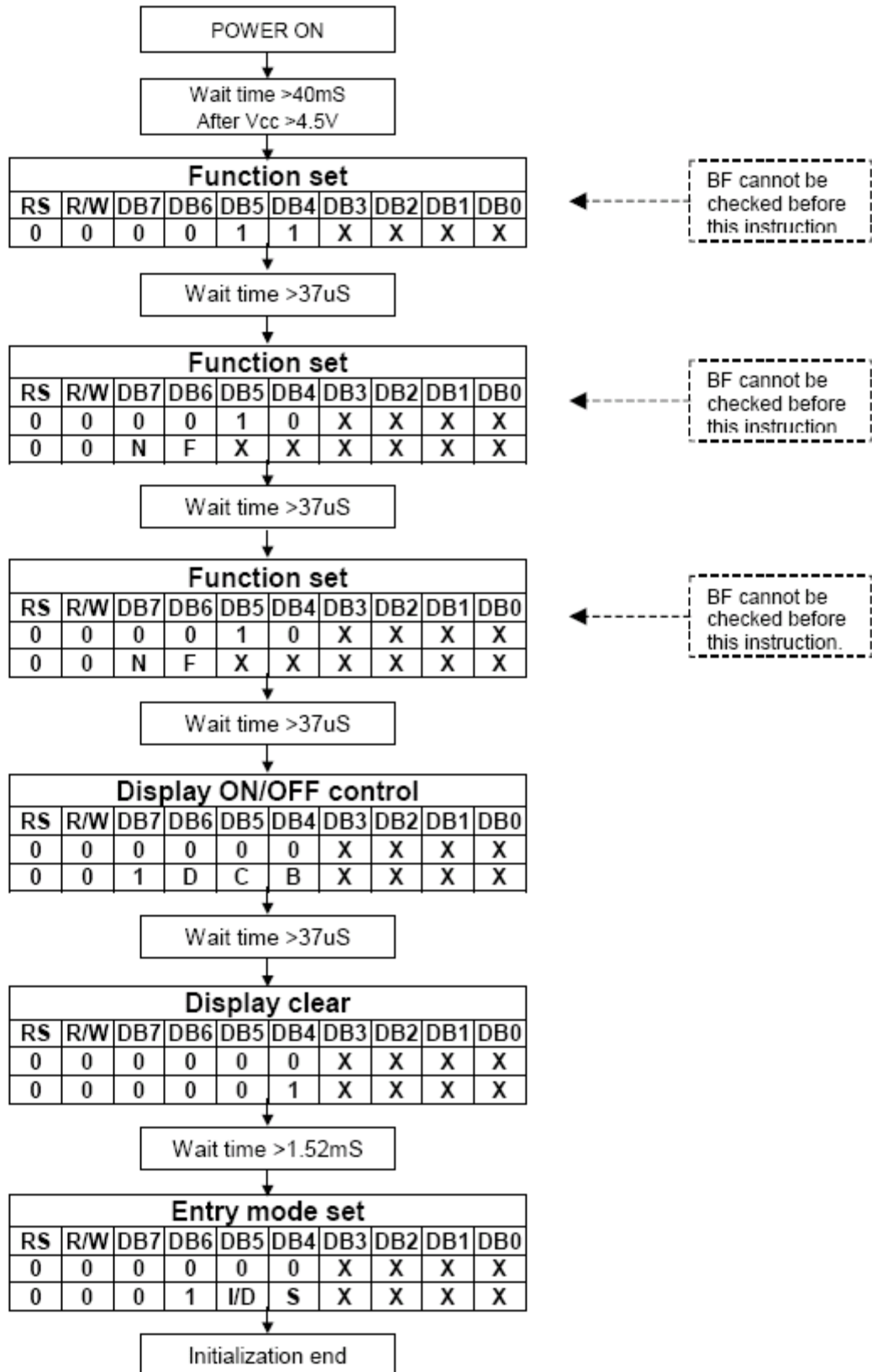

12. CHARACTER GENERATOR ROM (ST7066-0A)

NO.7066-0A

b7-b4 b3-b0	0000	0001	0010	0011	0100	0101	0110	0111	1000	1001	1010	1011	1100	1101	1110	1111
0000	CG RAM (1)			0	Q	P	\	P				-	9	3	o	p
0001	(2)		!	1	A	Q	a	9			u	7	7	4	a	q
0010	(3)		"	2	B	R	b	r			r	4	7	8	p	o
0011	(4)		#	3	C	S	c	s			j	9	7	e	e	o
0100	(5)		\$	4	D	T	d	t			\	i	t	t	p	o
0101	(6)		%	5	E	U	e	u			*	7	7	1	o	o
0110	(7)		&	6	F	V	f	v			7	7	2	o	p	z
0111	(8)		*	7	G	W	g	w			7	7	8	7	g	π
1000	(1)		<	8	H	X	h	x			4	9	7	7	j	z
1001	(2)		>	9	I	Y	i	y			o	7	7	7	7	y
1010	(3)		*	:	J	Z	j	z			e	o	7	7	j	z
1011	(4)		+	;	K	C	k	c			*	7	7	o	7	π
1100	(5)		,	<	L	*	l	l			7	9	7	7	7	π
1101	(6)		-	=	M	I	m	y			u	z	7	7	7	7
1110	(7)		.	>	N	^	n	7			o	7	7	7	7	7
1111	(8)		/	?	O	_	o	7			o	7	7	7	7	7

13. LCD MODULES HANDLING PRECAUTIONS

- Please remove the protection foil of polarizer before using.
- The display panel is made of glass. Do not subject it to a mechanical shock by dropping it from a high place, etc.
- If the display panel is damaged and the liquid crystal substance inside it leaks out, do not get any in your mouth. If the substance come into contact with your skin or clothes promptly wash it off using soap and water.
- Do not apply excessive force to the display surface or the adjoining areas since this may cause the color tone to vary.
- The polarizer covering the display surface of the LCD module is soft and easily scratched. Handle this polarize carefully.
- To prevent destruction of the elements by static electricity, be careful to maintain an optimum work environment.
 - Be sure to ground the body when handling the LCD module.
 - Tools required for assembly, such as soldering irons, must be properly grounded.
 - To reduce the amount of static electricity generated, do not conduct assembly and other work under dry conditions.
 - The LCD module is coated with a film to protect the display surface. Exercise care when peeling off this protective film since static electricity may be generated.
- Storage precautions
When storing the LCD modules, avoid exposure to direct sunlight or to the light of fluorescent lamps. Keep the modules in bags designed to prevent static electricity charging under low temperature / normal humidity conditions (avoid high temperature / high humidity and low temperatures below 0°C). Whenever possible, the LCD modules should be stored in the same conditions in which they were shipped from our company.

14. OTHERS

- Liquid crystals solidify at low temperature (below the storage temperature range) leading to defective orientation of liquid crystal or the generation of air bubbles (black or white). Air bubbles may also be generated if the module is subjected to a strong shock at a low temperature.
- If the LCD modules have been operating for a long time showing the same display patterns may remain on the screen as ghost images and a slight contrast irregularity may also appear. Abnormal operating status can be resumed to be normal condition by suspending use for some time. It should be noted that this phenomena does not adversely affect performance reliability.
- To minimize the performance degradation of the LCD modules resulting from caused by static electricity, etc. exercise care to avoid holding the following sections when handling the modules:
 - Exposed area of the printed circuit board
 - Terminal electrode sections.