

## Features

- Replacement for R-78Axx-1.0SMD series
- RoHS 6/6 Conform (100% Lead Free)
- High Reflow Temperature SMD Package
- Adjustable Output Voltage
- Short circuit protection, Thermal shutdown
- Remote On/Off Control
- Very Low Shutdown Current

## Description

The R-78Axx-1.0SMD series are manufactured without lead and meet the requirements for RoHS 6/6 as well as the increased reflow soldering temperatures associated with vapor phase soldering, making these high efficiency switching regulators ideally suited to modern pick-and-place mass production. The efficiency of up to 94% means that very little energy is wasted as heat. The additional features of remote on/off control and adjustable output voltages will find many uses in the battery-powered, industrial, medical and automotive markets.

## Selection Guide

Part Number SMD	Input Range (V)	Output Voltage (V)	Adjust Range (V)	Output Current (A)	Efficiency	
					Min. Vin (%)	Max. Vin (%)
R-78AA1.5-1.0SMD*	4.75 – 18	1.5	fixed	1.0	77	73
R-78AA1.8-1.0SMD*	4.75 – 18	1.8	1.5~3.0	1.0	82	76
R-78AA2.5-1.0SMD*	4.75 – 18	2.5	1.5~3.0	1.0	87	81
R-78AA3.3-1.0SMD*	4.75 – 18	3.3	3.0~5.5	1.0	90	84
R-78AA5.0-1.0SMD*	6.5 – 18	5.0	3.0~5.5	1.0	94	89

\* add suffix **-R** for tape&reel packing e.g. R-78AA5.0-1.0-R. For more details see Application Notes.

## Specifications ( typical at 25°C, 10% minimum load, unless otherwise specified )

Characteristics	Conditions	Min.	Typ.	Max.
Input Voltage Range	See Table	4.75V		18.0V
Output Voltage Range	See Table	1.5V		5.5V
Output Current	All Series	0mA*		1000mA
Short Circuit Input Current	Vin = 12V			120mA
Internal Power Dissipation				0.4W
Short Circuit Protection		Continuous, automatic recovery		
Output Voltage Accuracy	100% Load		±2%	±3%
Adjustable Voltage Range	See Table 1			±50%
Line Voltage Regulation (Vin = min to max at full load)			0.2%	0.4%
Load Regulation (10% to 100% full load)			0.7%	1.0%
Dynamic Load Stability	100% <-> 50% load, 25mA/μs		±85mV	±100mV
Ripple & Noise (20MHz BW)			20mVp-p	30mVp-p
Temperature Coefficient	-40°C~+85°C ambient			0.015%/°C
Max capacitance Load	with normal start-up time, no external components			470μF
	with <1 second start up time + diode protection circuit			6800μF
Switching Frequency		335kHz	385kHz	435kHz
Quiescent Current	Vin = min. to max. at 0% load		5mA	7mA
ON/OFF Remote Control Pin Drive Current	ON: Open or 1.6V<Vr<5V OFF: GND or 0<Vr<1.6V			Ir=1.8μA typ
Converter Input Current (valid for Vr < 1.6V)			20μA	35μA
Remote On/Off Threshold Voltage (Vr rising)		2.4V	2.6V	2.8V
Remote On/Off Voltage Hysteresis			250mV	
Operating Temperature Range		-40°C		+85°C
Switch On/Off Time	(using Remote On/Off Control)			50ms
Operating Case Temperature				+100°C
Storage Temperature Range		-55°C		+125°C
Case Thermal Impedance				70°C / W

continued on next page

## INNOLINE DC/DC-Converter

with 3 year Warranty

# RECOM

## 1.0 AMP SMD Single Output

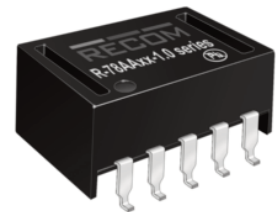

IEC/EN-60950-1 Certified

## R-78AA-1.0

## Derating-Graph (Ambient Temperature)

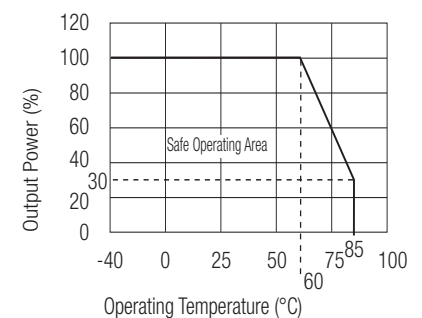

Refer to Application Notes

**Specifications** ( typical at 25°C, 10% minimum load, unless otherwise specified )

Case Material	Non-Conductive Black Plastic		
EMC	Conducted Emissions (with filter)	EN55022	Class B
	Radiated Emissions (with filter)	EN55022	Class B
	ESD	EN61000-4-2	Class A
	Radiated Immunity	EN61000-4-3	Class A
	Fast Transient	EN61000-4-4	Class A
	Conducted Immunity	EN61000-4-6	Class A
	Magnetic Field Immunity	EN61000-4-8	Class A

**Certifications**

IEC/EN General Safety	Report: SPCLVD 1407030-1	IEC/EN-60950-1, 2nd Edition
Package Weight		1.7g
Packing Quantity		33 pcs per Tube 250 pcs per Reel
MTBF (+25°C) (+71°C)	Detailed Information see Application Notes chapter "MTBF" using MIL-HDBK 217F	13338~21070 x 10 <sup>3</sup> hours
		3880~6769 x 10 <sup>3</sup> hours

\*Note: Operation under no load will not damage these devices, however they may not meet all specifications. A minimum load of 10mA is recommended

**Characteristics**

## Efficiency

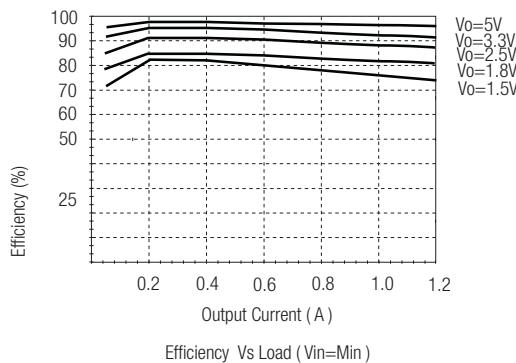
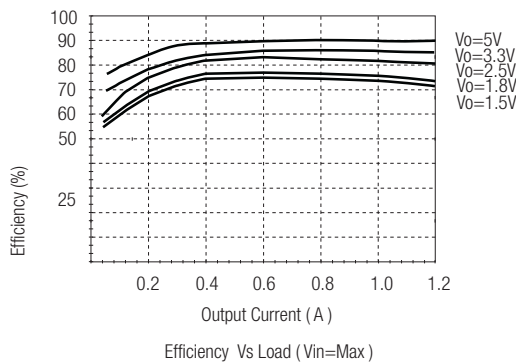
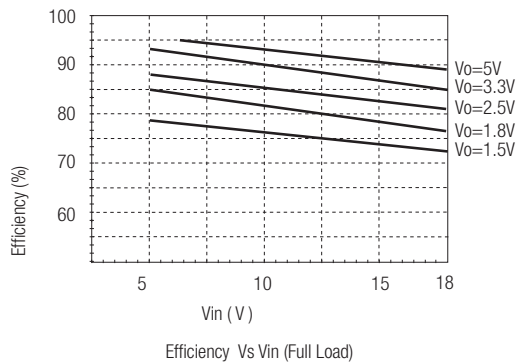

## Ripple

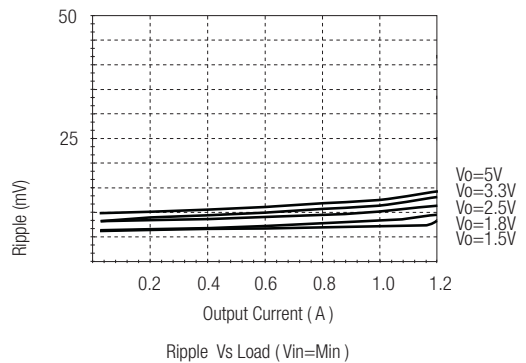
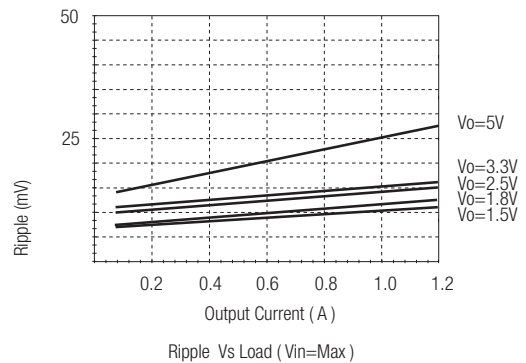
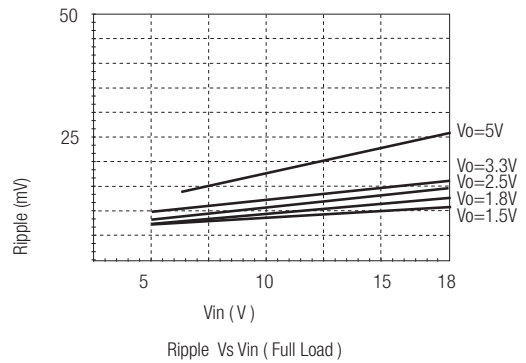

## Standard Application Circuit

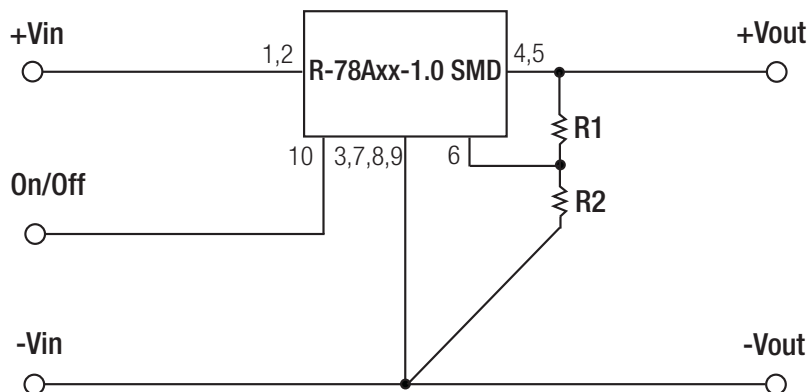

## Application Examples

### 3.3V/5V Selectable 1A Power Supply

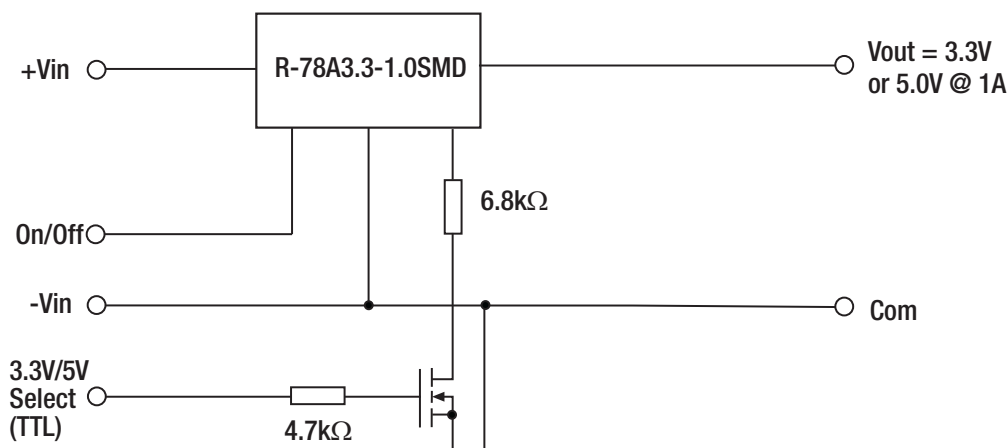

R-78AA-1.0

## Optional Protection Circuit

### Optional Protection 1:

Add a blocking diode to Vout if current can flow backwards into the output, as this can damage the converter when it is powered down.

The diode can either be fitted across the device if the source is low impedance or fitted in series with the output (recommended).

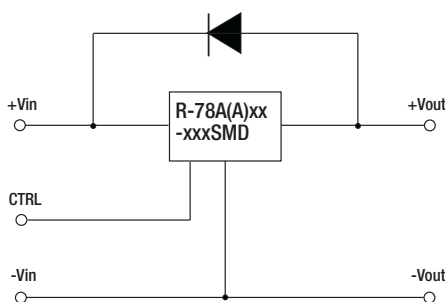

### Optional Protection 2:

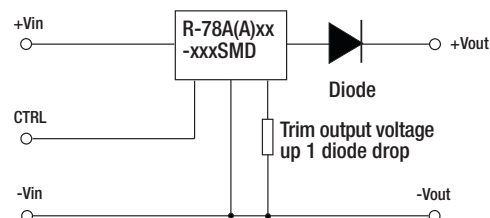

Application example:  
Driving a high capacitive load

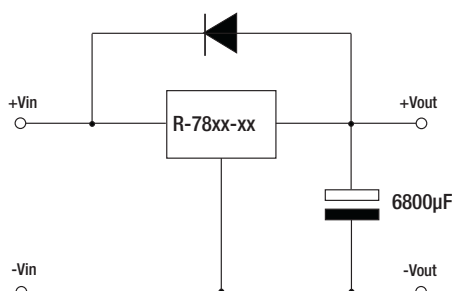

**Table 1: Adjustment Resistor Values**

	R1	R2	R3	Vref(V)
1.8V	10KΩ	21KΩ	5.6KΩ	1.23
2.5V	22KΩ	21KΩ	5.6KΩ	1.23
3.3V	16.9KΩ	10KΩ	5.6KΩ	1.23
5.0V	30.9KΩ	10KΩ	10KΩ	1.23

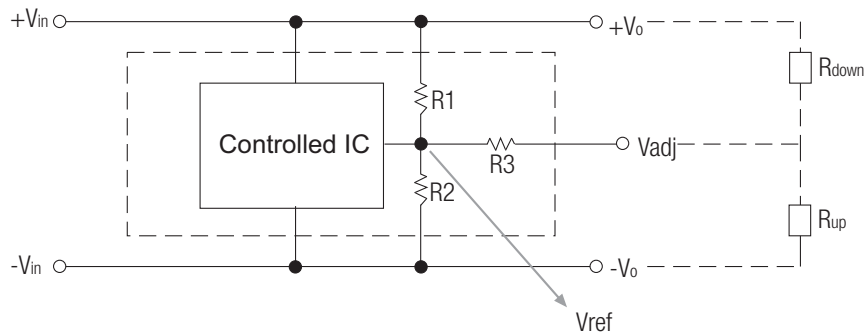

$$\text{Trim Down } R_{\text{down}} = \frac{R2(R1+R3) \times (V_{\text{ref}} - V_O) + V_{\text{ref}} \times R1R3}{R2V_O - V_{\text{ref}} (R1 + R2)}$$

$$\text{Trim up } R_{\text{up}} = \frac{R2R3 (V_{\text{ref}} - V_O) + V_{\text{ref}} R1 (R2 + R3)}{R2 (V_O - V_{\text{ref}}) - V_{\text{ref}} R1}$$

R-78AA-1.0

## Package Style and Pinning (mm)

### SMD 10Pin Package

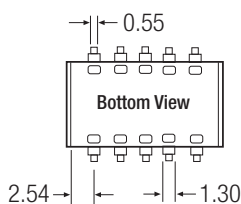
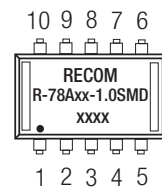
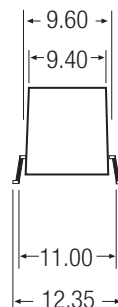
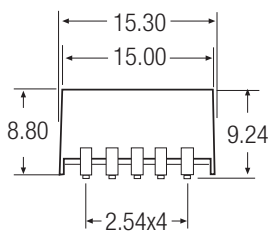

### Recommended Footprint Details

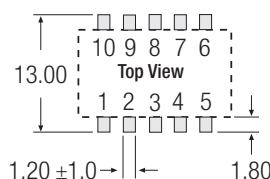

### Pin Connections

Pin #	Connection
1,2	+Vin
3,7,8,9	GND
4,5	+Vout
6	V adj
10	Remote On/Off
xx.x	±0.5mm
xx.xx	±0.25mm

The product information and specifications are subject to change without prior notice. RECOM products are not authorized for use in safety-critical applications (such as life support) without RECOM's explicit written consent. A safety-critical application is defined as an application where a failure of a RECOM product may reasonably be expected to endanger or cause loss of life, inflict bodily harm or damage property. The buyer shall indemnify and hold harmless RECOM, its affiliated companies and its representatives against any damage claims in connection with the unauthorized use of RECOM products in such safety-critical applications.