

MICRO SWITCH EJF SERIES



■ FEATURES

- 1-piece spring mechanism design offering durable acute operation and nice touch feeling
- Heavy/Light operation force specifications
- High flux-tight structure
- High solder reliability
- RoHS Compliant



■ APPLICATIONS

- Communication equipment
- Security systems
- Office automation appliances
- General industrial machines

■ SPECIFICATIONS

● Ratings	125VAC 3A; 125VAC 1A; 125VAC 0.1A
● Circuit arrangement	Single pole Double throw (1c), snap action
● Pitch between terminals	5.08mm

1.ELECTRICAL PERFORMANCE

● Insulation resistance	100M Ω Min. at 500VDC
● Dielectric strength	1000VAC Min. for 60sec
● Initial contact resistance	100m Ω Max.

2.MECHANICAL PERFORMANCE

● Operating Force (OF) Release Force (RF) Pre-travel (PT) Operating Position (OP) Free Position (FP)	see attached drawing
● Vibration Resistance(Without lever)	10 to 55 Hz amplitude of 1.5mm
● Terminal strength	1.2Kg(1 minute) in the direction of the axis of solder terminals

3.ENVIRONMENTAL

● Operating temperature	-25 $^{\circ}$ C ~ +65 $^{\circ}$ C (85%RH Max. without dew condensation)
● Storage temperature	-25 $^{\circ}$ C ~ +65 $^{\circ}$ C (85%RH Max. without dew condensation)

4.DURABILITY

● Mechanical life	1,000,000 cycles Operations
● Electrical life	30,000 cycles Operations

■ PART NUMBERING SYSTEM

EJF 1 1 1 1 0 XX

XX: Special product number

Package form:
0: tray





Terminal form:
1: straight type
2: self-standing type

Actuator type:
1: Pin Plunger
2: Straight Lever
3: Roller Lever
4: Simulated Roller Lever
5: Bend Lever

Contact Rating form:
1: 1A/125VAC
2: 3A/125VAC
3: 0.1A/125VAC

Operation Force:
1: 75gf (0.74N) Max.
2: 150gf (1.47N) Max.

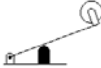
Series name:
EJF: J type micro switch, ultra miniature

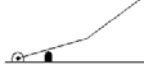
Actuators		
1	Pin Plunger	
2	Straight Lever	
3	Roller Lever	
4	Simulated Roller Lever	
5	Bend Lever	

DIMENSIONS

EJF-11110 DIMENSIONS

P/N.: EJF1111000 Unit:mm(inch)

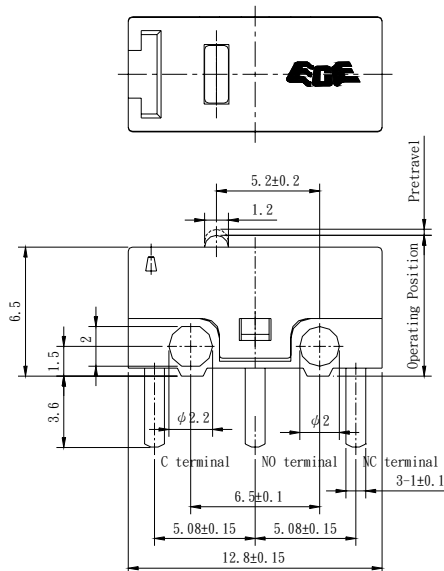

CIRCUIT DIAGRAM

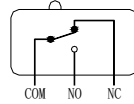

P. C. B LAYOUT

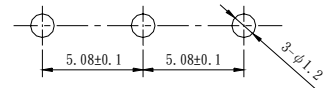

CONSTRUCTION

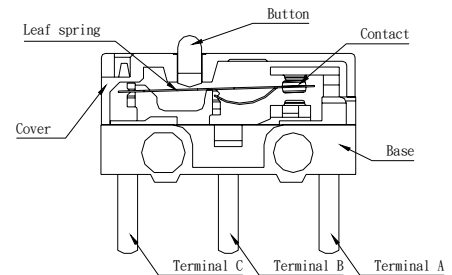

1. Operating Force (OF)	75gf (0.74N) Max.
2. Release Force (RF)	10gf (0.098N) Min.
3. Pretravel (PT)	0.5mm Max.
4. Movement Differential (MD)	0.12mm Max.
5. Operating Position (OP)	5.5±0.3mm

EJF-11120 DIMENSIONS

P/N.: EJF1112000 Unit:mm(inch)

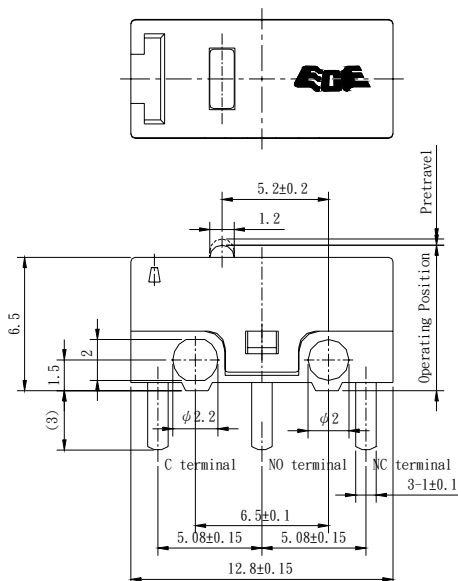

CIRCUIT DIAGRAM

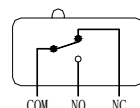

P. C. B LAYOUT

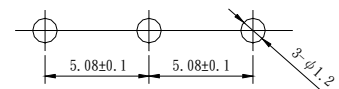

CONSTRUCTION

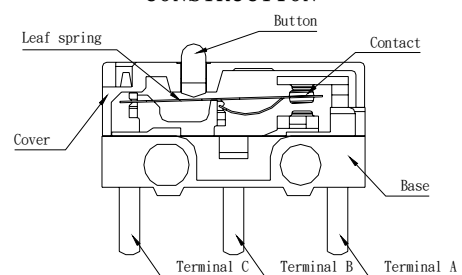

1. Operating Force (OF)	75gf (0.74N) Max.
2. Release Force (RF)	10gf (0.098N) Min.
3. Pretravel (PT)	0.5mm Max.
4. Movement Differential (MD)	0.12mm Max.
5. Operating Position (OP)	5.5±0.3mm

EJF-11210 DIMENSIONS

P/N. : EJF1121000 Unit:mm(inch)

CIRCUIT DIAGRAM

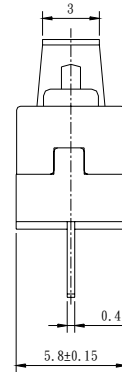
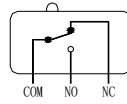
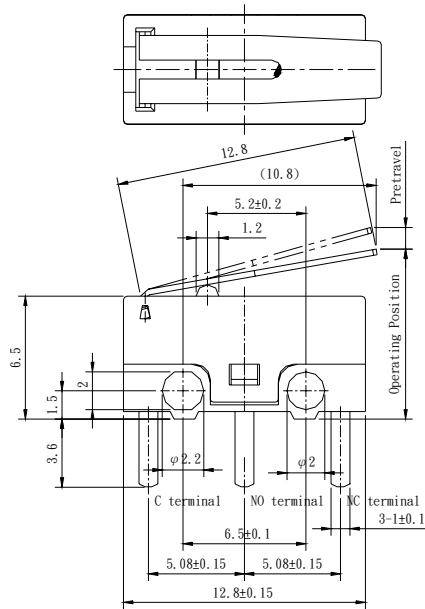

P. C. B LAYOUT

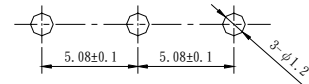

CONSTRUCTION

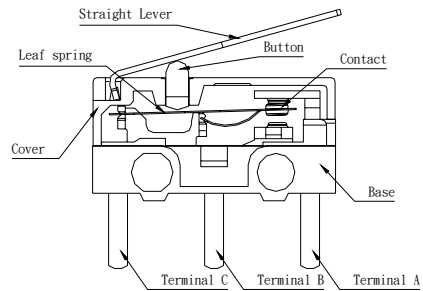

1. Operating Force (OF)	50gf (0.49N) Max.
2. Release Force (RF)	10gf (0.1N) Min.
3. Pretravel (PT)	2.1mm Max.
4. Movement Differential (MD)	0.5mm Max.
5. Operating Position (OP)	8.3±0.12mm

EJF-11410 DIMENSIONS

P/N. : EJF1141000 Unit:mm(inch)

CIRCUIT DIAGRAM

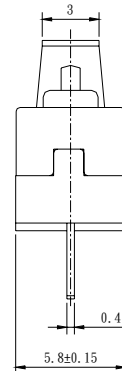
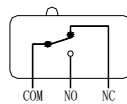
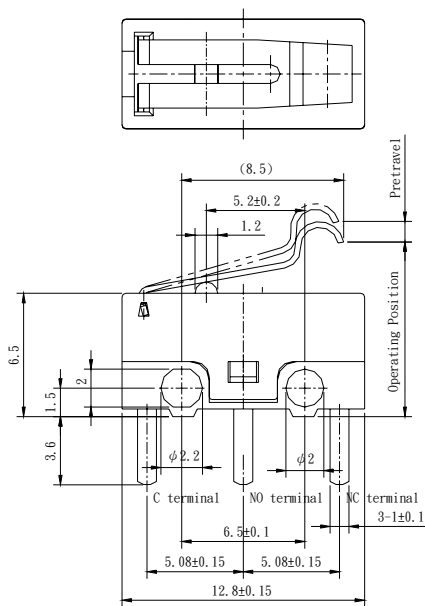

P. C. B LAYOUT

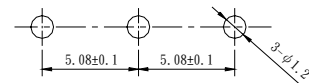

CONSTRUCTION

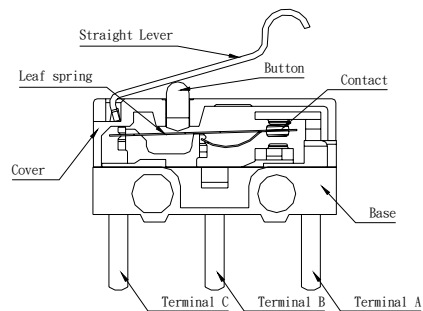

1. Operating Force (OF)	50gf (0.49N) Max.
2. Release Force (RF)	10gf (0.1N) Min.
3. Pretravel (PT)	2.1mm Max.
4. Movement Differential (MD)	0.5mm Max.
5. Operating Position (OP)	9.2±0.12mm

EJF-11510 DIMENSIONS

P/N. : EJF1151010 Unit:mm(inch)

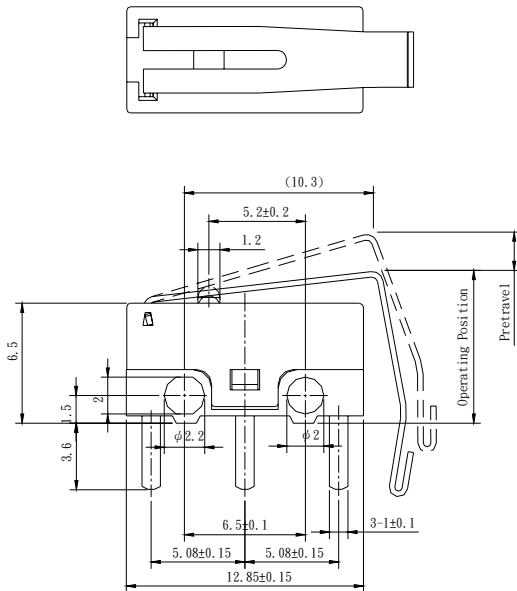

CIRCUIT DIAGRAM

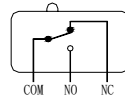

P. C. B LAYOUT

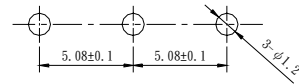

CONSTRUCTION

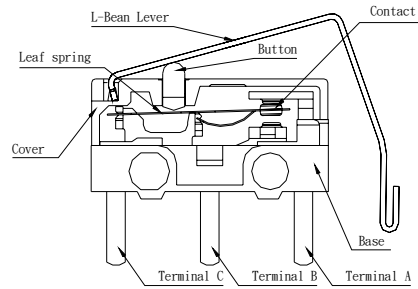

1. Operating Force (OF)	50gf (0.5N) Max.
2. Release Force (RF)	10gf (0.1N) Min.
3. Pretravel (PT)	2.2mm Max.
4. Movement Differential (MD)	0.5mm Max.
5. Operating Position (OP)	8.3±0.5mm

EJF-11520 DIMENSIONS

P/N. : EJF1152000 Unit:mm(inch)

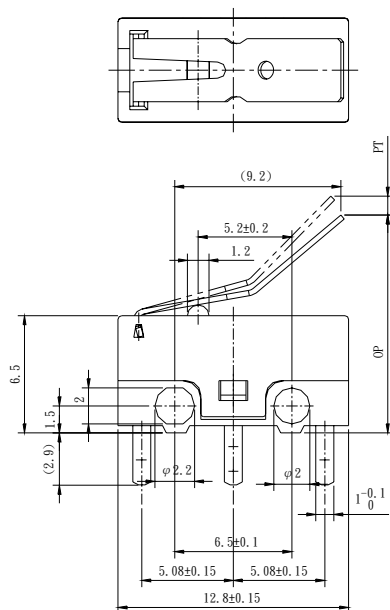

CIRCUIT DIAGRAM

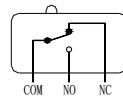

P. C. B LAYOUT

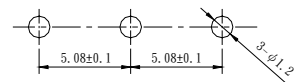

CONSTRUCTION

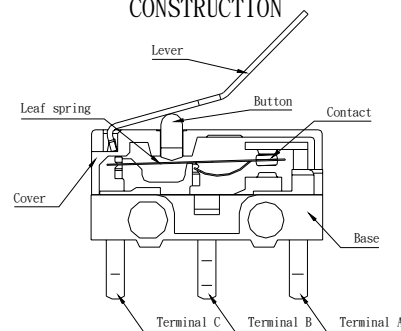

1. Operating Force (OF)	50gf (4.9N) Max.
2. Release Force (RF)	10gf (0.98N) Min.
3. Pretravel (PT)	2.1mm Max.
4. Movement Differential (MD)	0.5mm Max.
5. Operating Position(OP)	12.8±0.15mm

EJF-21110 DIMENSIONS

P/N.: EJF2111000 Unit:mm(inch)

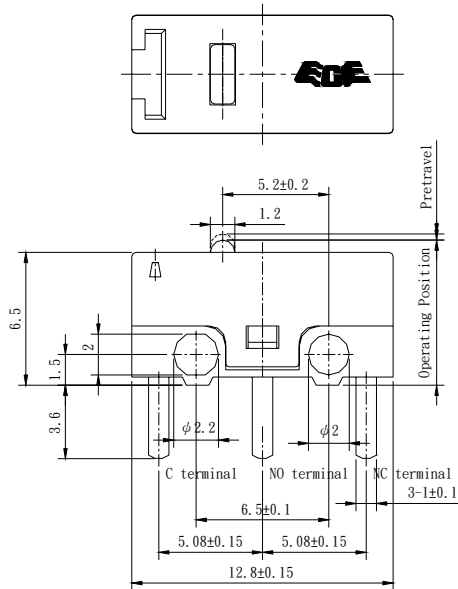

CIRCUIT DIAGRAM

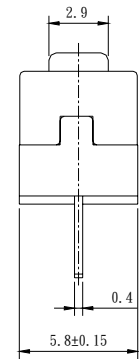
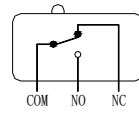

P. C. B LAYOUT

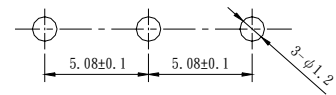

CONSTRUCTION

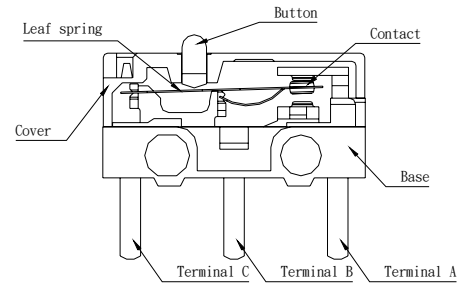

1.	Operating Force (OF)	150gf (1.47N) Max.
2.	Release Force (RF)	30gf (0.29N) Min.
3.	Pretravel (PT)	0.5mm Max.
4.	Movement Differential (MD)	0.12mm Max.
5.	Operating Position (OP)	5.5±0.3mm

EJF-21120 DIMENSIONS

P/N.: EJF2112000 Unit:mm(inch)

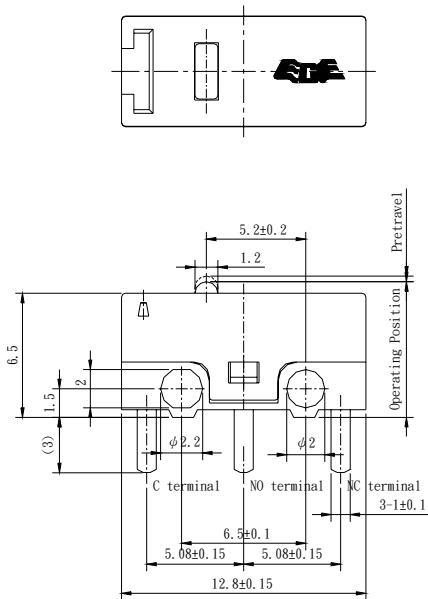

CIRCUIT DIAGRAM

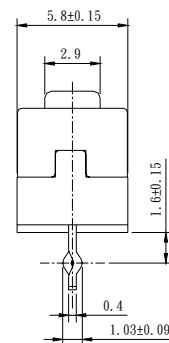
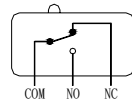

P. C. B LAYOUT

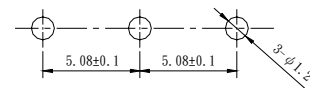

CONSTRUCTION

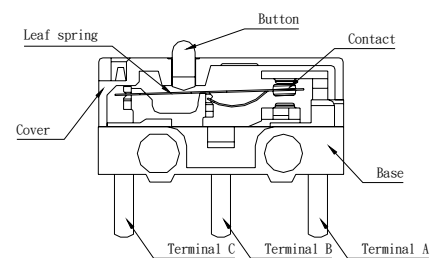

1.	Operating Force (OF)	150gf (1.47N) Max.
2.	Release Force (RF)	30gf (0.29N) Min.
3.	Pretravel (PT)	0.5mm Max.
4.	Movement Differential (MD)	0.12mm Max.
5.	Operating Position (OP)	5.5±0.3mm