

Optocoupler, Phototransistor Output, High Reliability, 5300 V_{RMS}

Features

- Excellent CTR Linearity Depending on Forward Current
- Isolation Test Voltage, 5300 V_{RMS}
- Fast Switching Times
- Low CTR Degradation
- Low Coupling Capacitance
- Lead (Pb)-free component
- Component in accordance to RoHS 2002/95/EC and WEEE 2002/96/EC

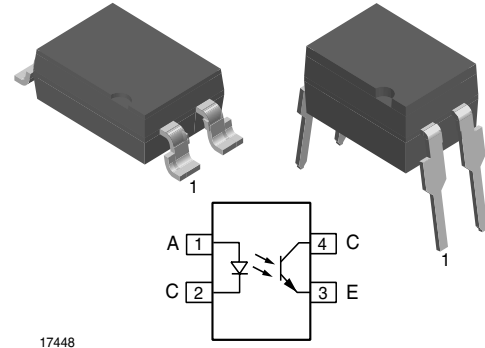

Agency Approvals

- UL1577, File No. E52744 System Code H or J, Double Protection
- DIN EN 60747-5-2 (VDE0884)
DIN EN 60747-5-5 pending
Available with Option 1

Applications

- Switchmode power supply
- Telecom
- Battery powered equipment

Description

The SFH615A (DIP) and SFH6156 (SMD) feature a variety of transfer ratios, low coupling capacitance and high isolation voltage. These couplers have a GaAs infrared diode emitter, which is optically coupled to a silicon planar phototransistor detector, and is incorporated in a plastic DIP-4 or SMD package.

The coupling devices are designed for signal transmission between two electrically separated circuits.

The couplers are end-stackable with 2.54 mm lead spacing.

Creepage and clearance distances of > 8.0 mm are achieved with option 6. This version complies with IEC 60950 (DIN VDE 0805) for reinforced insulation up to an operation voltage of 400 V_{RMS} or DC.

Specifications subject to change.

Order Information

Part	Remarks
SFH615A-1	CTR 40 - 80 %, DIP-4
SFH615A-2	CTR 63 - 125 %, DIP-4
SFH615A-3	CTR 100 - 200 %, DIP-4
SFH615A-4	CTR 160 - 320 %, DIP-4
SFH6156-1	CTR 40 - 80 %, SMD-4
SFH6156-2	CTR 63 - 125 %, SMD-4
SFH6156-3	CTR 100 - 200 %, SMD-4
SFH6156-4	CTR 160 - 320 %, SMD-4
SFH615A-1X006	CTR 40 - 80 %, DIP-4 400 mil (option 6)
SFH615A-1X007	CTR 40 - 80 %, SMD-4 (option 7)
SFH615A-2X006	CTR 63 - 125 %, DIP-4 400 mil (option 6)
SFH615A-2X007	CTR 63 - 125 %, SMD-4 (option 7)
SFH615A-2X009	CTR 63 - 125 %, SMD-4 (option 9)
SFH615A-3X006	CTR 100 - 200 %, DIP-4 400 mil (option 6)
SFH615A-3X007	CTR 100 - 200 %, SMD-4 (option 7)
SFH615A-3X008	CTR 100 - 200 %, SMD-4 (option 8)
SFH615A-3X009	CTR 100 - 200 %, SMD-4 (option 9)
SFH615A-4X006	CTR 160 - 320 %, DIP-4 400 mil (option 6)
SFH615A-4X007	CTR 160 - 320 %, SMD-4 (option 7)
SFH615A-4X008	CTR 160 - 320 %, SMD-4 (option 8)
SFH615A-4X009	CTR 160 - 320 %, SMD-4 (option 9)

For additional information on the available options refer to Option Information.

See TAPE AND REEL Section for 4-pin optocouplers T0 with 90° rotation.

Absolute Maximum Ratings

$T_{amb} = 25\text{ }^{\circ}\text{C}$, unless otherwise specified

Stresses in excess of the absolute Maximum Ratings can cause permanent damage to the device. Functional operation of the device is not implied at these or any other conditions in excess of those given in the operational sections of this document. Exposure to absolute Maximum Rating for extended periods of the time can adversely affect reliability.

Input

Parameter	Test condition	Symbol	Value	Unit
Reverse voltage		V_R	6.0	V
DC Forward current		I_F	60	mA
Surge forward current	$t_p \leq 10\text{ }\mu\text{s}$	I_{FSM}	2.5	A

Output

Parameter	Test condition	Symbol	Value	Unit
Collector-emitter voltage		V_{CE}	70	V
Emitter-collector voltage		V_{CEO}	7.0	V
Collector current		I_C	50	mA
	$t_p \leq 1.0\text{ ms}$	I_C	100	mA

Coupler

Parameter	Test condition	Symbol	Value	Unit
Isolation test voltage (between emitter and detector, referred to climate DIN 40046, part 2, Nov. 74)	$t = 1.0\text{ s}$	V_{ISO}	5300	V_{RMS}
Creepage			≥ 7.0	mm
Clearance			≥ 7.0	mm
Insulation thickness between emitter and detector			≥ 0.4	mm
Comparative tracking index per DIN IEC 112/VDE 0303, part 1			≥ 175	
Isolation resistance	$V_{IO} = 500\text{ V}, T_{amb} = 25\text{ }^{\circ}\text{C}$	R_{IO}	$\geq 10^{12}$	Ω
	$V_{IO} = 500\text{ V}, T_{amb} = 100\text{ }^{\circ}\text{C}$	R_{IO}	$\geq 10^{11}$	Ω
Storage temperature range		T_{stg}	- 55 to + 150	$^{\circ}\text{C}$
Ambient temperature range		T_{amb}	- 55 to + 100	$^{\circ}\text{C}$
Soldering temperature	max. 10 s, Dip soldering distance to seating plane $\geq 1.5\text{ mm}$	T_{sld}	260	$^{\circ}\text{C}$

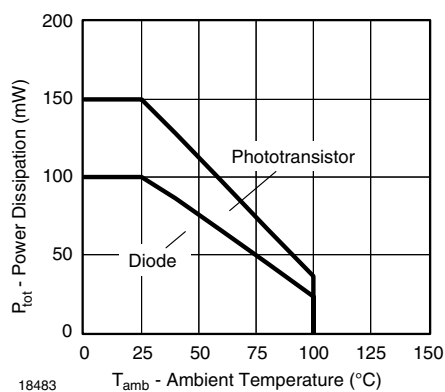

Figure 1. Permissible Power Dissipation vs. Ambient Temperature

Electrical Characteristics

$T_{amb} = 25\text{ }^{\circ}\text{C}$, unless otherwise specified

Minimum and maximum values are testing requirements. Typical values are characteristics of the device and are the result of engineering evaluation. Typical values are for information only and are not part of the testing requirements.

Input

Parameter	Test condition	Symbol	Min	Typ.	Max	Unit
Forward voltage	$I_F = 60\text{ mA}$	V_F		1.25	1.65	V
Reverse current	$V_R = 6.0\text{ V}$	I_R		0.01	10	μA
Capacitance	$V_R = 0\text{ V}$, $f = 1.0\text{ MHz}$	C_O		13		pF

Output

Parameter	Test condition	Part	Symbol	Min	Typ.	Max	Unit
Collector-emitter capacitance	$V_{CE} = 5.0\text{ V}$, $f = 1.0\text{ MHz}$		C_{CE}		5.2		pF
Collector-emitter leakage current	$V_{CE} = 10\text{ V}$	SFH615A-1 SFH6156-1	I_{CEO}		2.0	50	nA
		SFH615A-2 SFH6156-2	I_{CEO}		2.0	50	nA
		SFH615A-3 SFH6156-3	I_{CEO}		5.0	100	nA
		SFH615A-4 SFH6156-4	I_{CEO}		5.0	100	nA

Coupler

Parameter	Test condition	Symbol	Min	Typ.	Max	Unit
Collector-emitter saturation voltage	$I_F = 10\text{ mA}$, $I_C = 2.5\text{ mA}$	V_{CEsat}		0.25	0.4	V
Coupling capacitance		C_C		0.4		pF

Current Transfer Ratio

Parameter	Test condition	Part	Symbol	Min	Typ.	Max	Unit
I_C/I_F	$I_F = 10\text{ mA}$, $V_{CE} = 5.0\text{ V}$	SFH615A-1 SFH6156-1	CTR	40		80	%
		SFH615A-2 SFH6156-2	CTR	63		125	%
		SFH615A-3 SFH6156-3	CTR	100		200	%
		SFH615A-4 SFH6156-4	CTR	160		320	%
	$I_F = 1.0\text{ mA}$, $V_{CE} = 5.0\text{ V}$	SFH615A-1 SFH6156-1	CTR	13	30		%
		SFH615A-2 SFH6156-2	CTR	22	45		%
		SFH615A-3 SFH6156-3	CTR	34	70		%
		SFH615A-4 SFH6156-4	CTR	56	90		%



Switching Characteristics

Switching Non-saturated

Parameter	Test condition	Symbol	Min	Typ.	Max	Unit
Rise Time	$I_F = 10 \text{ mA}$, $V_{CC} = 5.0 \text{ V}$, $T_A = 25 \text{ }^\circ\text{C}$, $R_L = 75 \text{ } \Omega$	t_r		2.0		μs
Fall Time	$I_F = 10 \text{ mA}$, $V_{CC} = 5.0 \text{ V}$, $T_A = 25 \text{ }^\circ\text{C}$, $R_L = 75 \text{ } \Omega$	t_f		2.0		μs
Turn-on time	$I_F = 10 \text{ mA}$, $V_{CC} = 5.0 \text{ V}$, $T_A = 25 \text{ }^\circ\text{C}$, $R_L = 75 \text{ } \Omega$	t_{on}		3.0		μs
Turn-off time	$I_F = 10 \text{ mA}$, $V_{CC} = 5.0 \text{ V}$, $T_A = 25 \text{ }^\circ\text{C}$, $R_L = 75 \text{ } \Omega$	t_{off}		2.3		μs
Cut-off frequency	$I_F = 10 \text{ mA}$, $V_{CC} = 5.0 \text{ V}$, $T_A = 25 \text{ }^\circ\text{C}$, $R_L = 75 \text{ } \Omega$	f_{ctr}		250		kHz

Switching Saturated

Parameter	Test condition	Part	Symbol	Min	Typ.	Max	Unit
Rise time	$V_{CC} = 5.0 \text{ V}$, $T_A = 25 \text{ }^\circ\text{C}$, $R_L = 1 \text{ k}\Omega$, $I_F = 20 \text{ mA}$	SFH615A-1 SFH6156-1	t_r		2.0		μs
		SFH615A-2 SFH6156-2	t_r		3.0		μs
		SFH615A-3 SFH6156-3	t_r		3.0		μs
		SFH615A-4 SFH6156-4	t_r		4.6		μs
Fall time	$V_{CC} = 5.0 \text{ V}$, $T_A = 25 \text{ }^\circ\text{C}$, $R_L = 1 \text{ k}\Omega$, $I_F = 20 \text{ mA}$	SFH615A-1 SFH6156-1	t_f		11		μs
		SFH615A-2 SFH6156-2	t_f		14		μs
		SFH615A-3 SFH6156-3	t_f		14		μs
		SFH615A-4 SFH6156-4	t_f		15		μs
Turn-on time	$V_{CC} = 5.0 \text{ V}$, $T_A = 25 \text{ }^\circ\text{C}$, $R_L = 1 \text{ k}\Omega$, $I_F = 20 \text{ mA}$	SFH615A-1 SFH6156-1	t_{on}		3.0		μs
		SFH615A-2 SFH6156-2	t_{on}		4.2		μs
		SFH615A-3 SFH6156-3	t_{on}		4.2		μs
		SFH615A-4 SFH6156-4	t_{on}		6.0		μs
Turn-off time	$V_{CC} = 5.0 \text{ V}$, $T_A = 25 \text{ }^\circ\text{C}$, $R_L = 1 \text{ k}\Omega$, $I_F = 20 \text{ mA}$	SFH615A-1 SFH6156-1	t_{off}		18		μs
		SFH615A-2 SFH6156-2	t_{off}		23		μs
		SFH615A-3 SFH6156-3	t_{off}		23		μs
		SFH615A-4 SFH6156-4	t_{off}		25		μs

Typical Characteristics

$T_{amb} = 25\text{ }^{\circ}\text{C}$, unless otherwise specified

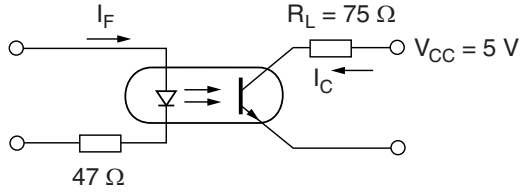

isfh615a_01

Figure 2. Linear Operation (without Saturation)

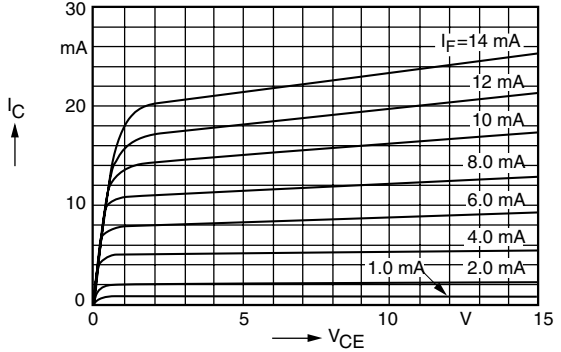

isfh615a_04

Figure 5. Output Characteristics (typ.) Collector Current vs. Collector-Emitter Voltage

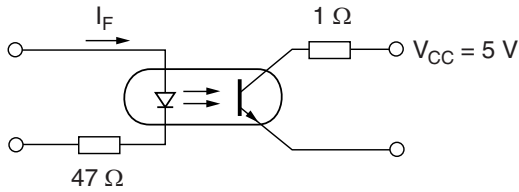

isfh615a_02

Figure 3. Switching Operation (with Saturation)

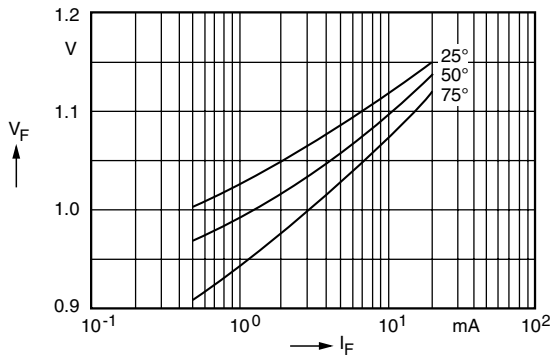

isfh615a_05

Figure 6. Diode Forward Voltage (typ.) vs. Forward Current

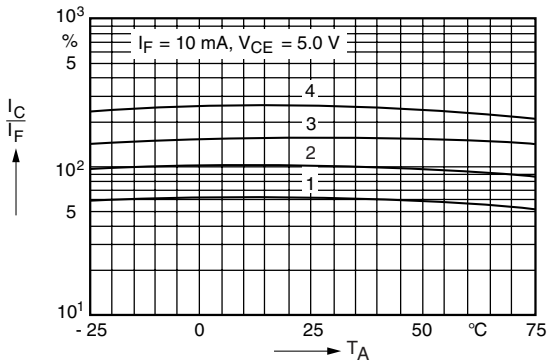

isfh615a_01

Figure 4. Current Transfer Ratio (typical) vs. Temperature

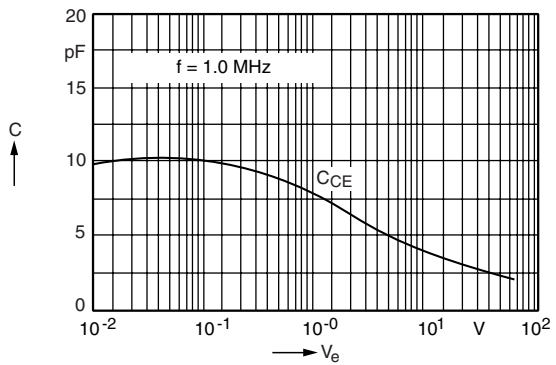

isfh615a_06

Figure 7. Transistor Capacitance (typ.) vs. Collector-Emitter Voltage

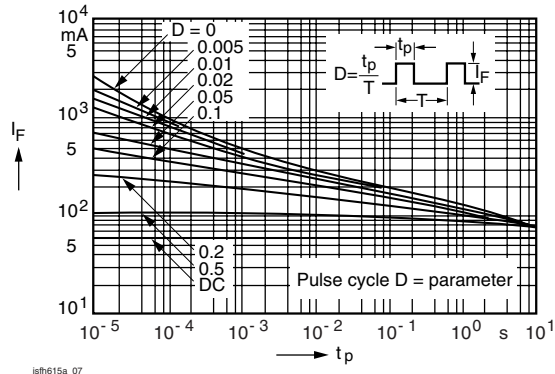
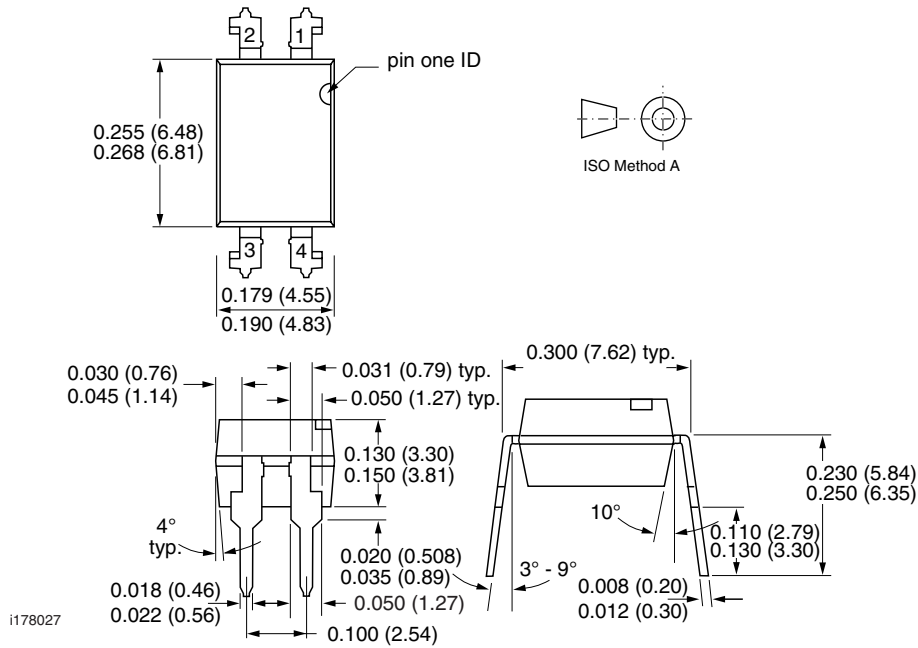
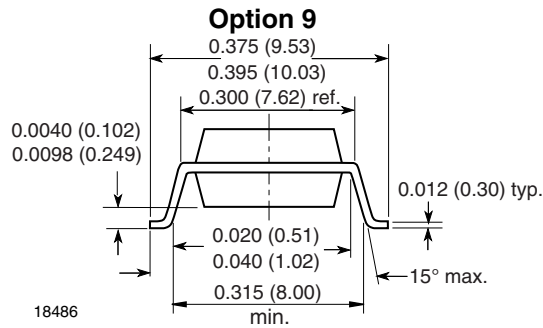
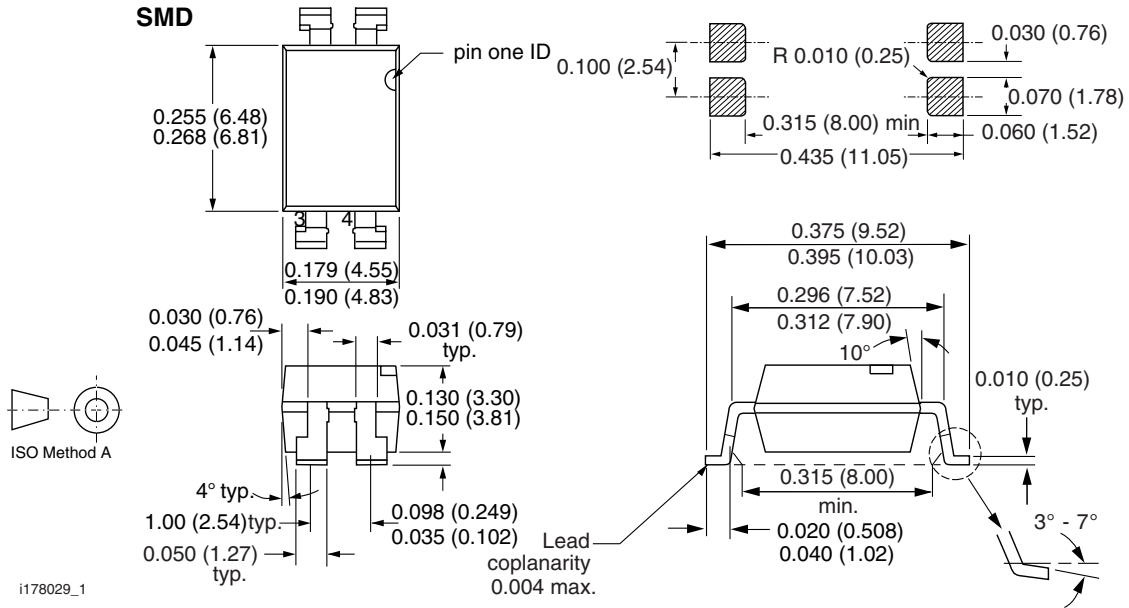

Figure 8. Permissible Pulse Handling Capability Forward Current vs. Pulse Width

Package Dimensions in Inches (mm)



Package Dimensions in Inches (mm)





Ozone Depleting Substances Policy Statement

It is the policy of Vishay Semiconductor GmbH to

1. Meet all present and future national and international statutory requirements.
2. Regularly and continuously improve the performance of our products, processes, distribution and operating systems with respect to their impact on the health and safety of our employees and the public, as well as their impact on the environment.

It is particular concern to control or eliminate releases of those substances into the atmosphere which are known as ozone depleting substances (ODSs).

The Montreal Protocol (1987) and its London Amendments (1990) intend to severely restrict the use of ODSs and forbid their use within the next ten years. Various national and international initiatives are pressing for an earlier ban on these substances.

Vishay Semiconductor GmbH has been able to use its policy of continuous improvements to eliminate the use of ODSs listed in the following documents.

1. Annex A, B and list of transitional substances of the Montreal Protocol and the London Amendments respectively
2. Class I and II ozone depleting substances in the Clean Air Act Amendments of 1990 by the Environmental Protection Agency (EPA) in the USA
3. Council Decision 88/540/EEC and 91/690/EEC Annex A, B and C (transitional substances) respectively.

Vishay Semiconductor GmbH can certify that our semiconductors are not manufactured with ozone depleting substances and do not contain such substances.

We reserve the right to make changes to improve technical design and may do so without further notice.

Parameters can vary in different applications. All operating parameters must be validated for each customer application by the customer. Should the buyer use Vishay Semiconductors products for any unintended or unauthorized application, the buyer shall indemnify Vishay Semiconductors against all claims, costs, damages, and expenses, arising out of, directly or indirectly, any claim of personal damage, injury or death associated with such unintended or unauthorized use.

Vishay Semiconductor GmbH, P.O.B. 3535, D-74025 Heilbronn, Germany



Notice

Specifications of the products displayed herein are subject to change without notice. Vishay Intertechnology, Inc., or anyone on its behalf, assumes no responsibility or liability for any errors or inaccuracies.

Information contained herein is intended to provide a product description only. No license, express or implied, by estoppel or otherwise, to any intellectual property rights is granted by this document. Except as provided in Vishay's terms and conditions of sale for such products, Vishay assumes no liability whatsoever, and disclaims any express or implied warranty, relating to sale and/or use of Vishay products including liability or warranties relating to fitness for a particular purpose, merchantability, or infringement of any patent, copyright, or other intellectual property right.

The products shown herein are not designed for use in medical, life-saving, or life-sustaining applications. Customers using or selling these products for use in such applications do so at their own risk and agree to fully indemnify Vishay for any damages resulting from such improper use or sale.