

Inlet with filter for front side mounting, fuse 1-/2-pole, line switch 2-pole

Standard- or Medical-Filter



new



C14



70° C



Description

- Panel Mount:
Screw-on from front side
- 4 Functions:
Inlet Protection class I, Line switch 2-pole, Fuseholder for fuse-links 5 x 20 mm 1- or 2-pole, Line filter in standard and medical version
- Quick connect terminals 6.3 x 0.8 mm
- Alternative: version without line filter [DD11](#)
- Alternative: version for snap-in mounting [KMF](#)

Approvals

- VDE License Number: E72928
- UL License Number: 4001522

Characteristics

- Ultra-compact design. Ideal for low profile designs
Aluminum case provides good shielding
- All single elements are already wired
- Fuse drawer meets requirements of medical standard IEC/EN 60601-1
The fuseholder is accessible from the equipment front
For added safety "Extra-Safe" fuse drawers are available
- Ideal for application with high transient loads
Designed for standard and medical applications
- Qualified for use in equipment according IEC/EN 60950

Other versions on request

- Solder terminals
- Fuse drawer 1-pole, plus spare fuse case
- Fuse drawer 2-pole, with shorting bar
- Other rocker marking
- Line switch, illuminated
- Line switch 1-pole
- Medical version M80
- Class X1- and Y1-capacitors for enhanced withstand voltage
- Protection class II, 70°C

References

[General Product Information](#)

Weblinks

[Approvals](#), [RoHS](#), [CHINA-RoHS](#), [e-Store](#), [SCHURTER-Stock-Check](#), [Distributor-Stock-Check](#)

Technical Data

| | | | |
|---------------------------|--|-----------------------------------|---|
| Ratings IEC | 1 - 10A @ Ta 40 °C / 250VAC; 50Hz | Appliance-Inlet /-Outlet | C14 acc. to IEC/EN 60320-1 UL 498, CSA C22.2 no. 42 (for cold condition) pin-temperature 70 °C, 10A, Protection class I |
| Ratings UL/CSA | 1 - 8A @ Ta 40 °C / 250VAC; 60Hz | Fuseholder | 1 or 2 pole, Shocksafe category PC2 acc. to IEC 60127-6, for fuse-links 5 x 20mm |
| Leakage Current | standard < 0.5mA (250V / 60Hz) medical < 5 µA (250 V / 60 Hz) | Rated Power Acceptance @ Ta 23 °C | 5 x 20: 2W (1 pole)/ 1.6W (2-pole) per pole |
| Dielectric Strength | > 1.7kVDC between L-N > 2.7kVDC between L/N-PE Test voltage (1 min/50Hz) | Power Acceptance @ Ta > 23°C | Admissible power acceptance at higher ambient temperature see derating curves |
| Allowable Operation Temp. | -25 °C to 85 °C | Line Switch | Rocker switch 2-pole, non-illuminated, acc. to IEC 61058-1 Technical details |
| Climatic Category | 25/085/21 acc. to IEC 60068-1 | Line Filter | Standard and Medical Version, IEC 60939, IEC 60601-1, UL 1283, UL 544, EN 133 200, CSA C22.2 no. 8 Technical details |
| Degree of Protection | from front side IP 40 acc. to IEC 60529 | MTBF | > 2'000'000h acc. to MIL-HB-217 F |
| Protection Class | Suitable for appliances with protection class I acc. to IEC 61140 | | |
| Terminal | Quick connect terminals 6.3 x 0.8 mm | | |
| Panel Thickness s | Screw-on: max 8mm Mounting screw torque max 0.5Nm | | |
| Material: Housing | Thermoplastic, black, UL 94V-0 | | |

Dimensions

Screw version

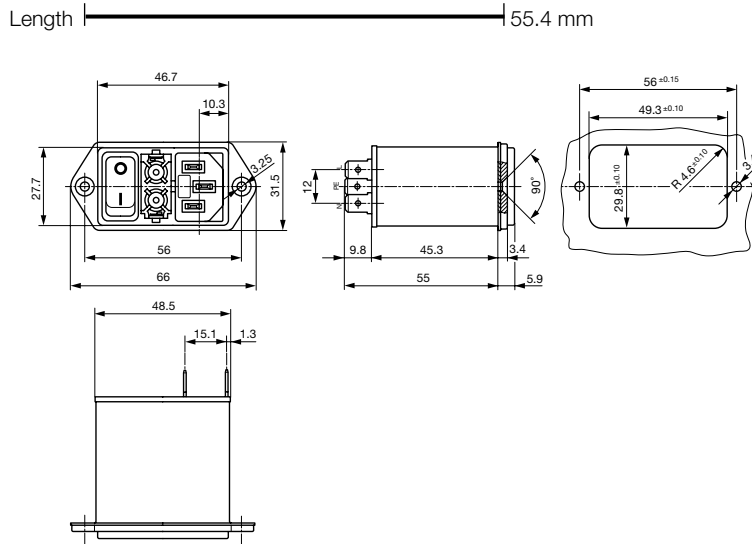

Technical Data of Filter-Components

| Rated Current [A] | Filter-Type | Inductances L [mH] | Capacitance CX [nF] | Capacitance CY [nF] | R [MΩ] |
|-------------------|----------------------|--------------------|---------------------|---------------------|--------|
| 1 | Standard Version | 2 x 10 | 100 | 2.2 | 1 |
| 2 | Standard Version | 2 x 4 | 100 | 2.2 | 1 |
| 4 | Standard Version | 2 x 1.5 | 100 | 2.2 | 1 |
| 6 | Standard Version | 2 x 0.8 | 100 | 2.2 | 1 |
| 8 | Standard Version | 2 x 0.6 | 100 | 2.2 | 1 |
| 10 | Standard Version | 2 x 0.3 | 100 | 2.2 | 1 |
| 1 | Medical Version (M5) | 2 x 10 | 100 | - | 1 |
| 2 | Medical Version (M5) | 2 x 4 | 100 | - | 1 |
| 4 | Medical Version (M5) | 2 x 1.5 | 100 | - | 1 |
| 6 | Medical Version (M5) | 2 x 0.8 | 100 | - | 1 |
| 8 | Medical Version (M5) | 2 x 0.6 | 100 | - | 1 |
| 10 | Medical Version (M5) | 2 x 0.3 | 100 | - | 1 |

Diagrams

Filter standard
non illuminated

Filter Medical M5
non illuminated

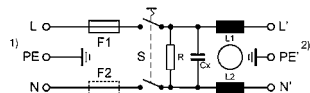
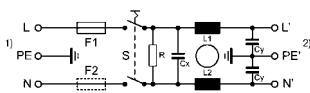

1) Line
2) Load

1) Line
2) Load

Derating Curves for Fuseholders

1-pole

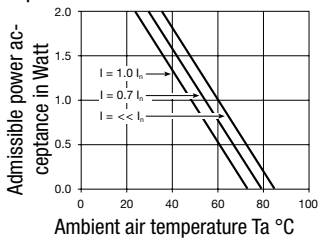

2-pole

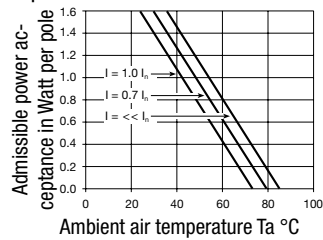

Attenuation Loss

--- differential mode — common mode

Standard version

1 A

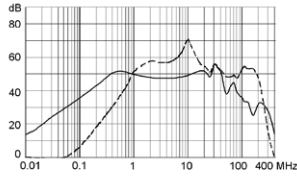

2 A

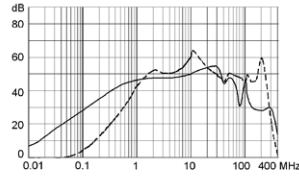

4 A

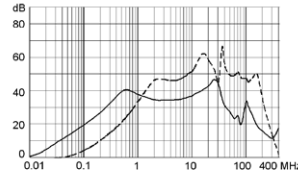

6 A

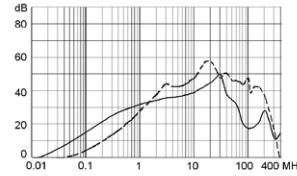

8 A

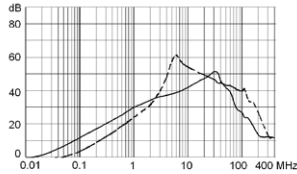

10 A

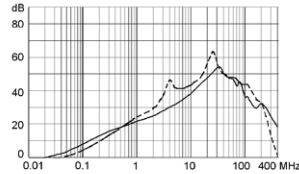

Medical version (M5)

1 A

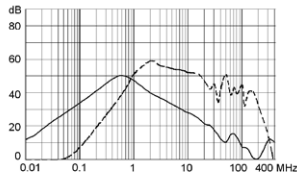

2 A

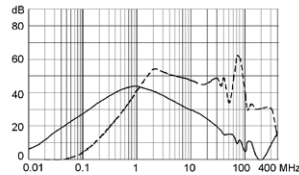

4 A

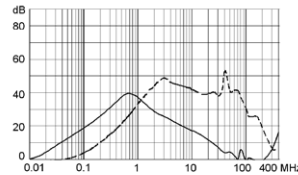

6 A

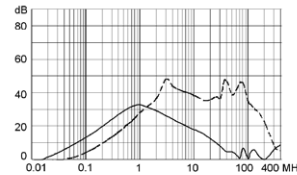

8 A

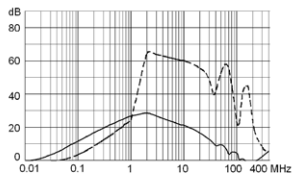

10 A

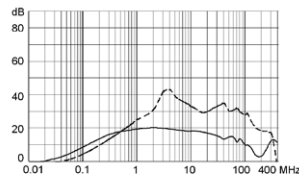

Variants

[Distributor-Stock-Check](#) | [SCHURTER-Stock-Check](#) | [e-Store](#)

Fuse drawer must be ordered separately (see accessories).
Fingergrip and Extra Safe. The same drawer as used by type KEA.

| Rated Current [A] | Filter-Type | Fuseholder | Line Switch | Order Number |
|-------------------|----------------------|------------|-------------|---------------|
| 1 | Standard Version | 1 pole | 2-pole | DD12.1111.111 |
| 2 | Standard Version | 1 pole | 2-pole | DD12.2111.111 |
| 4 | Standard Version | 1 pole | 2-pole | DD12.4111.111 |
| 6 | Standard Version | 1 pole | 2-pole | DD12.6111.111 |
| 8 | Standard Version | 1 pole | 2-pole | DD12.8111.111 |
| 10 | Standard Version | 1 pole | 2-pole | DD12.9111.111 |
| 1 | Standard Version | 2-pole | 2-pole | DD12.1121.111 |
| 2 | Standard Version | 2-pole | 2-pole | DD12.2121.111 |
| 4 | Standard Version | 2-pole | 2-pole | DD12.4121.111 |
| 6 | Standard Version | 2-pole | 2-pole | DD12.6121.111 |
| 8 | Standard Version | 2-pole | 2-pole | DD12.8121.111 |
| 10 | Standard Version | 2-pole | 2-pole | DD12.9121.111 |
| 1 | Medical Version (M5) | 2-pole | 2-pole | DD12.1321.111 |
| 2 | Medical Version (M5) | 2-pole | 2-pole | DD12.2321.111 |
| 4 | Medical Version (M5) | 2-pole | 2-pole | DD12.4321.111 |

| Rated Current [A] | Filter-Type | Fuseholder | Line Switch | Order Number |
|-------------------|----------------------|------------|-------------|---------------|
| 6 | Medical Version (M5) | 2-pole | 2-pole | DD12.6321.111 |
| 8 | Medical Version (M5) | 2-pole | 2-pole | DD12.8321.111 |
| 10 | Medical Version (M5) | 2-pole | 2-pole | DD12.9321.111 |

Packaging unit 20 Pcs

Required Accessory

Description



Fusedrawer 2
Fusedrawer with and without voltage selector insert

Accessory



Assorted Covers
Rear Cover



Cord retaining kits
Cord retaining strain relieve