

Display Elektronik GmbH

DATA SHEET

LCD MODULE

**DEM 1024768C VMH-PW-N
(C-TOUCH)**

**10,4" TFT
with Projective Capacitive Touch**

Product Specification

Ver.:1

25.09.2019

Revise Records

Rev.	Date	Contents	Written	Approved																																																																																																														
0	21.03.2019	Preliminary Specification	CL	MHO																																																																																																														
1	25.09.2019	Add IIS	CL	MHO																																																																																																														
		Modify Color Chromaticity <table border="1" style="margin-left: 40px;"> <tr> <td rowspan="2">Color Chromaticity (CIE 1931)</td> <td rowspan="2">White</td> <td>Wx</td> <td rowspan="2">$\theta=0^\circ$ Normal Viewing Angle</td> <td>(0.29)</td> <td>(0.34)</td> <td>(0.39)</td> </tr> <tr> <td>Wy</td> <td>(0.37)</td> <td>(0.42)</td> <td>(0.47)</td> </tr> </table> <p style="text-align: center;">↓</p> <table border="1" style="margin-left: 40px;"> <tr> <td rowspan="2">Color Chromaticity (CIE 1931)</td> <td rowspan="2">White</td> <td>Wx</td> <td rowspan="2">$\theta=0^\circ$ Normal Viewing Angle</td> <td>(0.28)</td> <td>(0.33)</td> <td>(0.38)</td> <td rowspan="2">--</td> <td rowspan="2">BM-7A</td> </tr> <tr> <td>Wy</td> <td>(0.348)</td> <td>(0.398)</td> <td>(0.448)</td> </tr> </table>	Color Chromaticity (CIE 1931)	White	Wx	$\theta=0^\circ$ Normal Viewing Angle	(0.29)	(0.34)	(0.39)	Wy	(0.37)	(0.42)	(0.47)	Color Chromaticity (CIE 1931)	White	Wx	$\theta=0^\circ$ Normal Viewing Angle	(0.28)	(0.33)	(0.38)	--	BM-7A	Wy	(0.348)	(0.398)	(0.448)																																																																																								
Color Chromaticity (CIE 1931)	White	Wx			$\theta=0^\circ$ Normal Viewing Angle		(0.29)	(0.34)	(0.39)																																																																																																									
		Wy	(0.37)	(0.42)		(0.47)																																																																																																												
Color Chromaticity (CIE 1931)	White	Wx	$\theta=0^\circ$ Normal Viewing Angle	(0.28)	(0.33)	(0.38)	--	BM-7A																																																																																																										
		Wy		(0.348)	(0.398)	(0.448)																																																																																																												
		Modify 3.1.3 DC Electrical Characteristics of the TFT LCD <table border="1" style="margin-left: 40px;"> <thead> <tr> <th>Item</th> <th>Symbol</th> <th>Min.</th> <th>Typ.</th> <th>Max.</th> <th>Unit</th> <th>Remark</th> </tr> </thead> <tbody> <tr> <td>Power supply Logic Voltage</td> <td>VCC</td> <td>3.0</td> <td>3.3</td> <td>3.6</td> <td>V</td> <td></td> </tr> <tr> <td>Power supply LED Voltage</td> <td>VLED</td> <td>-</td> <td>12</td> <td>-</td> <td>V</td> <td></td> </tr> <tr> <td rowspan="2">Input Voltage for logic</td> <td>H Level</td> <td>V_{IH}</td> <td>0.7xVDD</td> <td>-</td> <td>VDD</td> <td>V</td> </tr> <tr> <td>L Level</td> <td>V_{IL}</td> <td>0</td> <td>-</td> <td>0.3xVDD</td> <td>V</td> </tr> <tr> <td>Power Supply current</td> <td>ICC</td> <td>-</td> <td>TBD</td> <td>TBD</td> <td>mA</td> <td>Note 1</td> </tr> <tr> <td>Power Supply current (LED Driver)</td> <td>I_{LED}</td> <td>-</td> <td>TBD</td> <td>TBD</td> <td>mA</td> <td>VLED=12V</td> </tr> <tr> <td>LED Life time</td> <td>-</td> <td>(50000)</td> <td>-</td> <td>-</td> <td>Hrs</td> <td>Note 2</td> </tr> </tbody> </table> <p style="text-align: center;">↓</p> <table border="1" style="margin-left: 40px;"> <thead> <tr> <th>Item</th> <th>Symbol</th> <th>Min.</th> <th>Typ.</th> <th>Max.</th> <th>Unit</th> <th>Remark</th> </tr> </thead> <tbody> <tr> <td>Power supply Logic Voltage</td> <td>VCC</td> <td>3.0</td> <td>3.3</td> <td>3.6</td> <td>V</td> <td></td> </tr> <tr> <td>Power supply LED Voltage</td> <td>VLED</td> <td>-</td> <td>12</td> <td>-</td> <td>V</td> <td></td> </tr> <tr> <td rowspan="2">Input Voltage for logic</td> <td>H Level</td> <td>V_{IH}</td> <td>0.7xVDD</td> <td>-</td> <td>VDD</td> <td>V</td> </tr> <tr> <td>L Level</td> <td>V_{IL}</td> <td>0</td> <td>-</td> <td>0.3xVDD</td> <td>V</td> </tr> <tr> <td>Power Supply Current for LCM</td> <td>ICC</td> <td>-</td> <td>(320)</td> <td>(360)</td> <td>mA</td> <td>Note 1</td> </tr> <tr> <td>Power Supply Current (LED Driver)</td> <td>I_{LED}</td> <td>-</td> <td>(550)</td> <td>(650)</td> <td>mA</td> <td>VLED=12V</td> </tr> <tr> <td>LED Life time</td> <td>-</td> <td>(50000)</td> <td>-</td> <td>-</td> <td>Hrs</td> <td>Note 2</td> </tr> </tbody> </table>	Item	Symbol	Min.	Typ.	Max.	Unit	Remark	Power supply Logic Voltage	VCC	3.0	3.3	3.6	V		Power supply LED Voltage	VLED	-	12	-	V		Input Voltage for logic	H Level	V _{IH}	0.7xVDD	-	VDD	V	L Level	V _{IL}	0	-	0.3xVDD	V	Power Supply current	ICC	-	TBD	TBD	mA	Note 1	Power Supply current (LED Driver)	I _{LED}	-	TBD	TBD	mA	VLED=12V	LED Life time	-	(50000)	-	-	Hrs	Note 2	Item	Symbol	Min.	Typ.	Max.	Unit	Remark	Power supply Logic Voltage	VCC	3.0	3.3	3.6	V		Power supply LED Voltage	VLED	-	12	-	V		Input Voltage for logic	H Level	V _{IH}	0.7xVDD	-	VDD	V	L Level	V _{IL}	0	-	0.3xVDD	V	Power Supply Current for LCM	ICC	-	(320)	(360)	mA	Note 1	Power Supply Current (LED Driver)	I _{LED}	-	(550)	(650)	mA	VLED=12V	LED Life time	-	(50000)	-	-	Hrs	Note 2		
Item	Symbol	Min.	Typ.	Max.	Unit	Remark																																																																																																												
Power supply Logic Voltage	VCC	3.0	3.3	3.6	V																																																																																																													
Power supply LED Voltage	VLED	-	12	-	V																																																																																																													
Input Voltage for logic	H Level	V _{IH}	0.7xVDD	-	VDD	V																																																																																																												
	L Level	V _{IL}	0	-	0.3xVDD	V																																																																																																												
Power Supply current	ICC	-	TBD	TBD	mA	Note 1																																																																																																												
Power Supply current (LED Driver)	I _{LED}	-	TBD	TBD	mA	VLED=12V																																																																																																												
LED Life time	-	(50000)	-	-	Hrs	Note 2																																																																																																												
Item	Symbol	Min.	Typ.	Max.	Unit	Remark																																																																																																												
Power supply Logic Voltage	VCC	3.0	3.3	3.6	V																																																																																																													
Power supply LED Voltage	VLED	-	12	-	V																																																																																																													
Input Voltage for logic	H Level	V _{IH}	0.7xVDD	-	VDD	V																																																																																																												
	L Level	V _{IL}	0	-	0.3xVDD	V																																																																																																												
Power Supply Current for LCM	ICC	-	(320)	(360)	mA	Note 1																																																																																																												
Power Supply Current (LED Driver)	I _{LED}	-	(550)	(650)	mA	VLED=12V																																																																																																												
LED Life time	-	(50000)	-	-	Hrs	Note 2																																																																																																												

Special Notes

Note1.	
Note2.	

Contents

1.	General Description and Features	4
1.1	Features	4
1.2	LCD Module	4
2.	Mechanical Information	4
3.	Electrical Specifications	5
3.1	Absolute Max. Ratings	5
4.	Optical Characteristics	8
4.1	Optical characteristic of the LCD	8
5.	I/O Terminal	10
5.1	Pin Assignment (MSB24013P20A or equivalent.)	10
5.2	Back-light (CN2:ENTERY 3808K-F05N-03L or Equivalent)	11
5.3	Block Diagram	12
6.	Displayed Color and Input Data	13
7.	Projected Capacitive Touch Panel	14
7.1	Main Feature	14
7.2	Pin Assignment for CTP (User Part No.:5F2.2535E-A3821.110 or equivalent.)	14
8.	Reliability Condition	15
9.	Dimensional Outlines	16
10.	Incoming Inspection Standards	17

1. General Description and Features

This TFT is a transmissive type color active matrix TFT (Thin Film Transistor) liquid crystal display (LCD) that uses amorphous silicon TFT as a switching device. This model is composed of a TFT-LCD module, a receiver circuit, and a back-light unit. Graphics and texts can be displayed on a HD 1024 (W) x 3 x 768 (H) dots (4:3 aspect ratio) with 262K/16.2M colors by supplying 18/24 bits data signal (8bits/each color). The following table described the features of this TFT.

1.1 Features

- Transmissive and back-light with 30 LEDs are available.
- MVA mode.
- LVDS Receiver 24 bit Interface.
- CTP(USB interface)

1.2 LCD Module

Item	Specification	Unit
Screen Size	10.4 inches	Diagonal
Display Resolution	1024 x 768	Pixel
Active Area	211.20 x 158.40	mm
Outline Dimension	259.20 x 206.40 x 10.80	mm
Display Mode	Normally Black mode/ Transmissive	--
Surface Treatment	Clear , 7H	--
Pixel Arrangement	R,G,B Vertical Stripe	--
Pixel Size	206.25 x 206.25	um
Display Color	262K/16.2M	--
Viewing Direction	Full View	--
Input Interface	LVDS Receiver 24 bit Interface	--

2. Mechanical Information

Item	Min.	Typ.	Max.	Unit	Note
Module Size	Horizontal (H)	--	(259.2)	--	mm
	Vertical (V)	--	(206.4)	--	mm
	Thickness (T)	--	(10.8)	--	mm
Weight	--	(TBD)	--	g	--

Note (1) Not Include Component. Refer to the Outline Dimension Drawing as attached.

3. Electrical Specifications

3.1 Absolute Max. Ratings

3.1.1 Absolute Ratings of Environment

If the operating condition exceeds the following absolute maximum ratings, the TFT LCD module may be damaged permanently.

(Ta=25±2°C, GND=0)

Item	Symbol	Min.	Max.	Unit	Note
Storage Temperature	T _{STG}	-30	80	°C	(1)
Operating Temperature	T _{OPR}	-20	70	°C	(1,2,3)

Note (1) 95 % RH Max. (40°C ≥ Ta). Maximum wet-bulb temperature at 39°C or less. (Ta > 40°C) No condensation.

Note (2) In case of below 0°, the response time of liquid crystal (LC) becomes slower and the color of panel becomes darker than normal one. Level of retardation depends on temperature, because of LC's character

Note (3) Only operation is guaranteed at operating temperature. Contrast, response time, another display quality are evaluated at +25°C.

3.1.2 Electrical Absolute Maximum Ratings

(V_{SS}=GND=0)

Parameter	Symbol	Min.	Max.	Unit	Remark
Power Supply Logic Voltage	VCC	-0.3	4.0	V	
Power Supply LED Voltage	VLED	-0.3	18	V	
Permissive Input Ripple Voltage	V _{RF}	--	100	mVp-p	VCC=3.3V

Display On/Off Sequence :

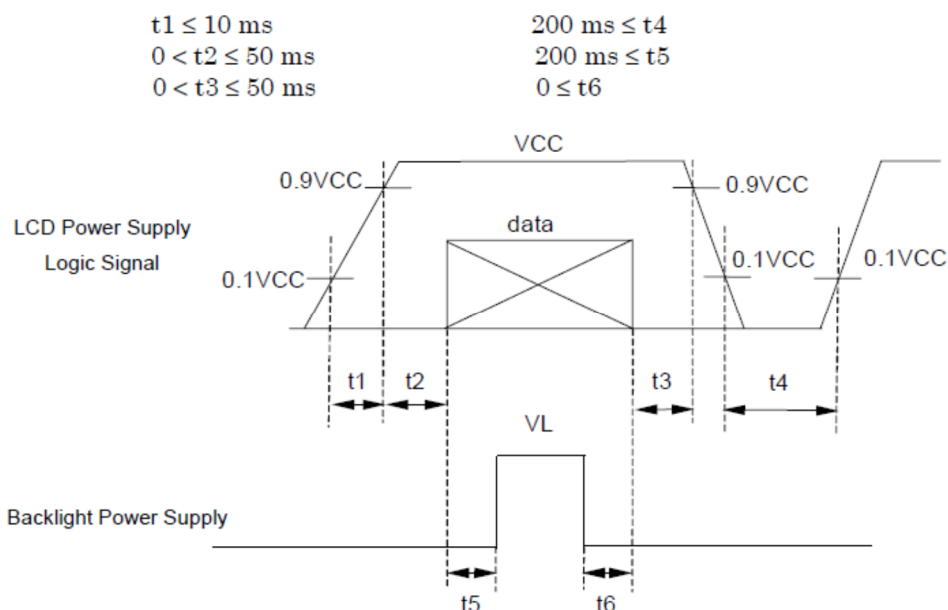

3.1.3 DC Electrical Characteristics of the TFT LCD

(Ta=25±2°C, GND=0)

Item		Symbol	Min.	Typ.	Max.	Unit	Remark
Power supply Logic Voltage		VCC	3.0	3.3	3.6	V	
Power supply LED Voltage		VLED	-	12	-	V	
Input Voltage for logic	H Level	VIH	0.7xVDD	-	VDD	V	
	L Level	VIL	0	-	0.3xVDD	V	
Power Supply current		ICC	-	TBD	TBD	mA	Note 1
Power Supply current (LED Driver)		ILED	-	TBD	TBD	mA	VLED=12V
LED Life time		-	(50000)	-	-	Hrs	Note 2

Note : 1 : White Pattern & 60Hz



Note2: The environmental conducted under ambient air flow, at Ta=25±2°C, 60%RH±5%

3.1.4 AC Timing Condition

Signal	Parameter	Symbol	Min.	Typ.	Max.	Unit.	Remark
DCLK	CLK frequency	fclk	52	65	71	MHz	
Horizontal Timing	Horizontal display area	Thd	1024			DCLK	
	HSYNC period time	Th	1114	1344	1400	DCLK	
	HSYNC Blanking	thb+thfp	90	320	376	DCLK	
Vertical Timing	Vertical display area	Tvd	768			TH	
	VSYNC Period time	Tv	778	806	845	TH	
	VSYNC Blanking	Tvb+tvfp	10	38	77	TH	

3.1.5 Timing Characteristic

3.1.5.1 Horizontal Timing

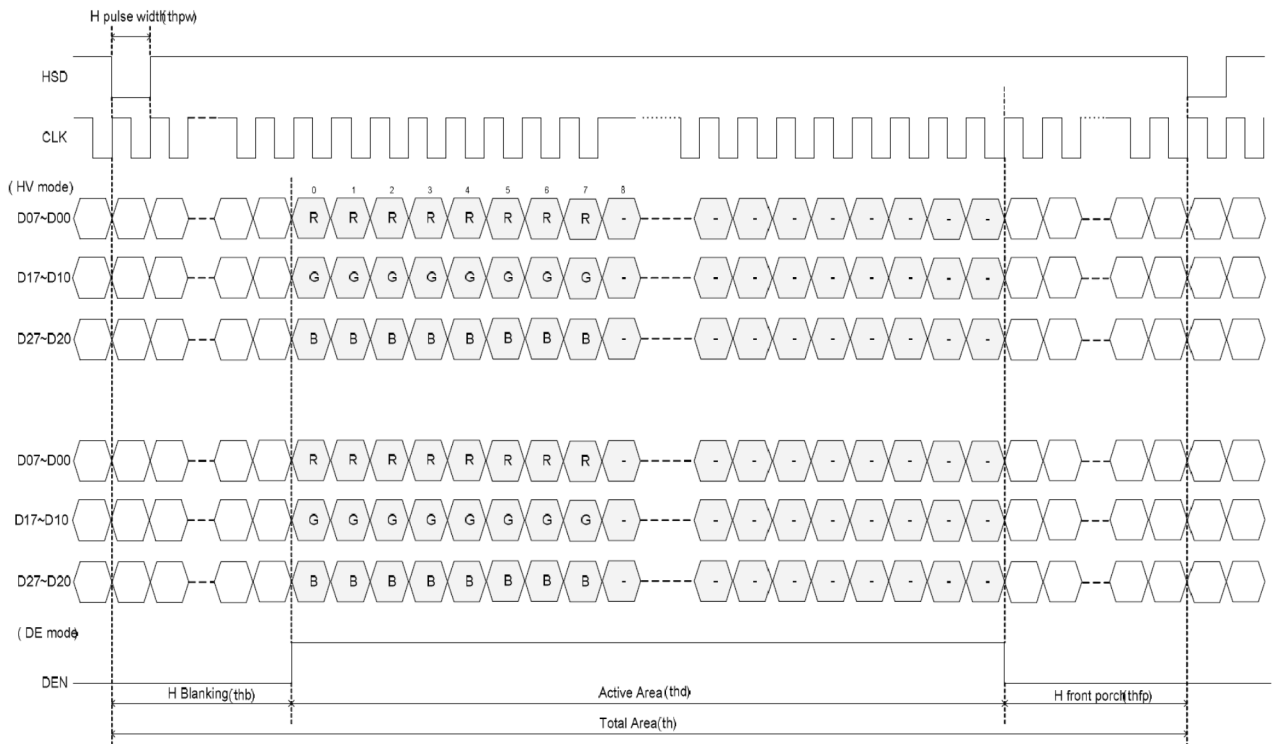

3.1.5.2 Vertical Timing

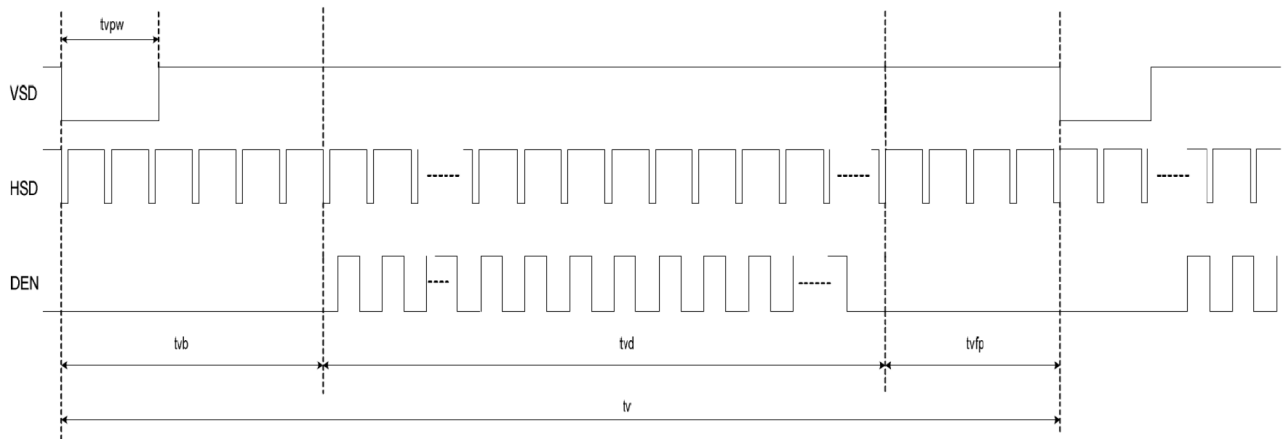

4. Optical Characteristics

4.1 Optical characteristic of the LCD

The following items are measured under stable conditions. The optical characteristics should be measured in a dark room or equivalent state with the methods.

Measuring equipment: BM-7A

Item	Symbol	Condition	Min	Type	Max	Unit	Note	
Brightness	B		(800)	(900)	--	cd/m ²		
Response time	T _r +T _f	θ=0°	-	30	40	ms	.	
Contrast ratio	CR	At optimized viewing angle	(600)	(900)	--	--		
Luminance Uniformity	ΔL		70	75		%		
Color Chromaticity (CIE 1931)	White	W _x	θ=0° Normal Viewing Angle	(0.28)	(0.33)	(0.38)	--	BM-7A
		W _y		(0.348)	(0.398)	(0.448)		
Viewing Angle	Hor.	θ _R	CR≥10	80	85	--	Degree	
		θ _L		80	85	--		
	Ver.	θ _U		80	85	--		
		θ _D		80	85	--		

a. Test equipment setup

After stabilizing and leaving the panel alone shall be warmed up for the stable operation of LCM, the measurement should be executed. Measurement should be executed in a stable, windless, and dark room. Optical specifications are measured by Topcon BM-7A(fast) with a viewing angle of 2° at a distance of 50cm and normal direction.

b. Definition of response time: Tr and Tf

The response time is defined as the following figure and shall be measured by switching the input signal for "black" and "white".

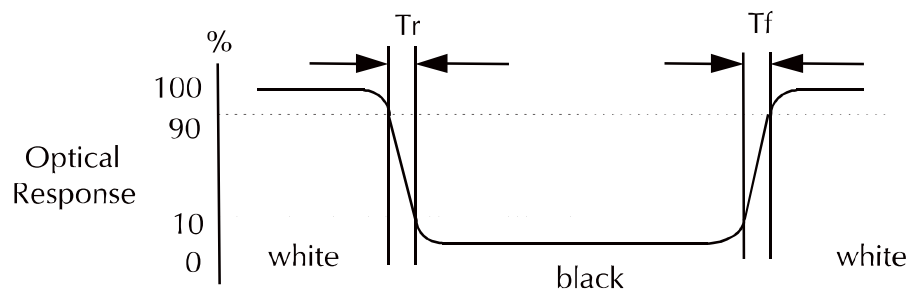

c. Definition of contrast ratio:

$$\text{Contrast Ratio (CR)} = \frac{\text{Brightness measured when LCD is at "white state"}}{\text{Brightness measured when LCD is at "black state"}}$$

- d. Measured at the center area of the panel when all the input terminals of LCD panel are electrically opened.
- e. View Angle

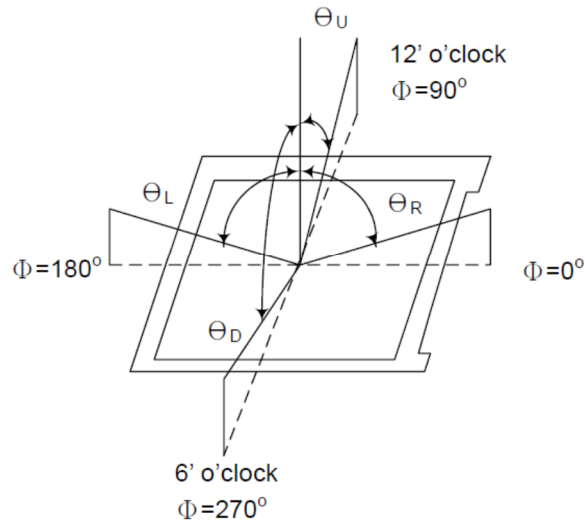

- f. Definition of Luminance of White: Luminance of white at the center points

Light Source of Back-Light Unit	LED Type
---------------------------------	----------

- g. Definition of White Uniformity

$$\text{White Uniformity} = \frac{\text{Min. luminance of white among 9-points}}{\text{Max. luminance of white among 9-points}} \times 100\%$$

5. I/O Terminal

5.1 Pin Assignment (MSB24013P20A or equivalent.)

Pin No.	Symbol	I/O	Function	Remark
1	VCC	P	Power Supply for LCM	
2	VCC	P	Power Supply for LCM	
3	SELB	P	6bit/8bit mode select	Note 1
4	GND	P	Ground	
5	RXI0-	I	Negative LVDS differential data 0 input	
6	RXI0+	I	Positive LVDS differential data 0 input	
7	GND	P	Ground	
8	RXI1-	I	Negative LVDS differential data 1 input	
9	RXI1+	I	Positive LVDS differential data 1 input	
10	GND	P	Ground	
11	RXI2-	I	Negative LVDS differential data 2 input	
12	RXI2+	I	Positive LVDS differential data 2 input	
13	GND	P	Ground	
14	RXICLK-	I	Negative LVDS differential CLK input	
15	RXICLK+	I	Positive LVDS differential CLK input	
16	GND	P	Ground	
17	RXI3-	I	Negative LVDS differential data 3 input	
18	RXI3+	I	Positive LVDS differential data 3 input	
19	GND	P	Ground	
20	GND	P	Ground	

I: Input, O: Output, P: Power

Note 1: LVDS Input

6 bit LVDS Input

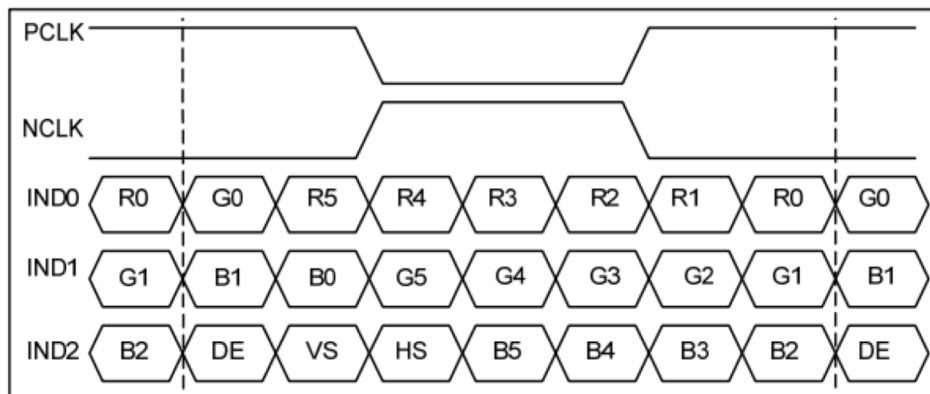

8 bit LVDS Input

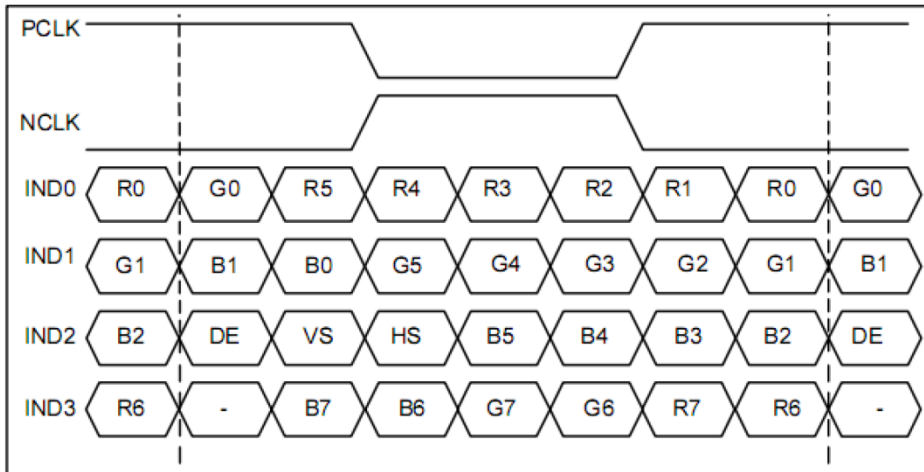

5.2 Backlight (CN2:ENTERY 3808K-F05N-03L or Equivalent)

Pin No.	Symbol	I/O	Function	Remark
1	VLED	P	Power Supply voltage for Backlight	
2	GND	P	Ground	
3	ON/OFF	P	Backlight ON/OFF	
4	Dimming	P	Adjust brightness	Note 2
5	GND	P	Ground	

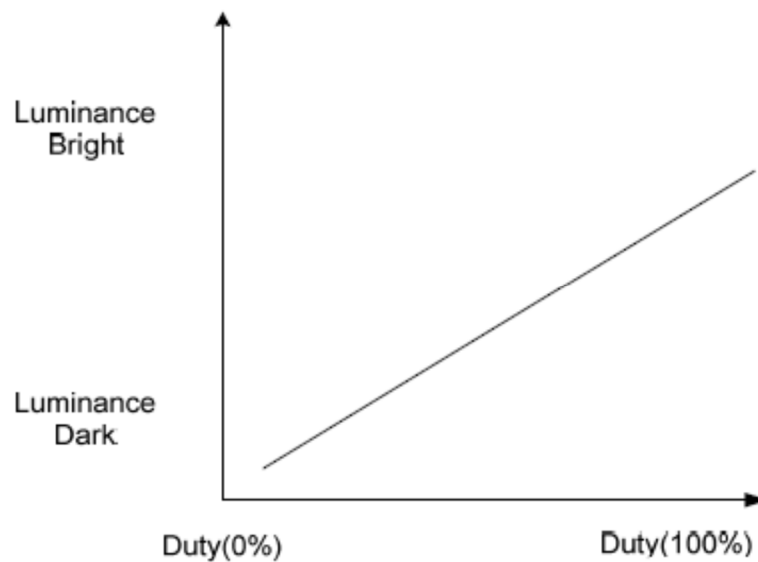

Note 2: Diming signal=0~3.3V, Operating frequency:100Hz~1KHz

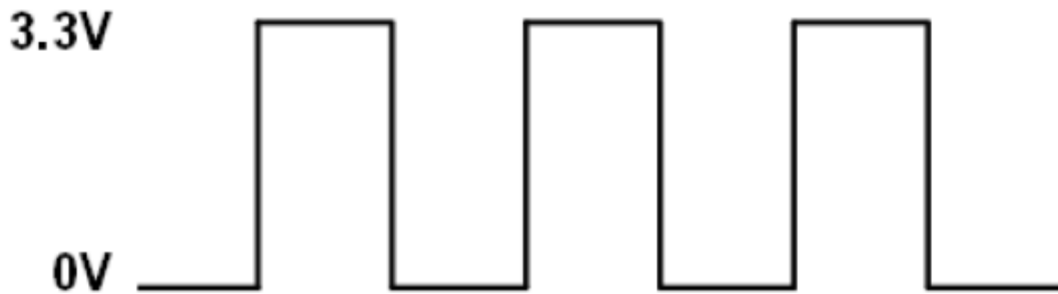

5.3 Block Diagram

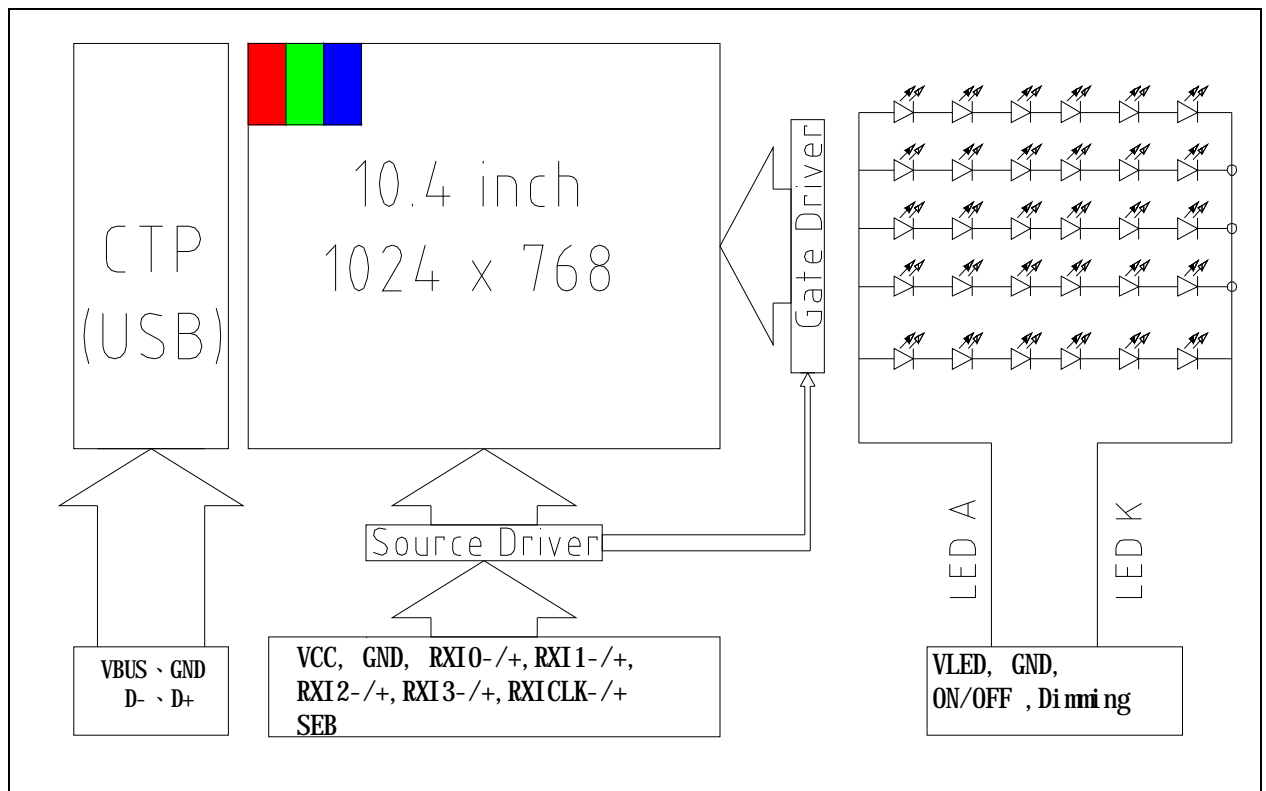

6. Displayed Color and Input Data

	Color & Gray Scale	Data Signal																	
		R5	R4	R3	R2	R1	R0	G5	G4	G3	G2	G1	G0	B5	B4	B3	B2	B1	B0
Basic Color	Black	0	0	0	0	0	0	0	0	0	0	0	0	0	0	0	0	0	0
	Red(0)	1	1	1	1	1	1	0	0	0	0	0	0	0	0	0	0	0	0
	Green(0)	0	0	0	0	0	0	1	1	1	1	1	1	0	0	0	0	0	0
	Blue(0)	0	0	0	0	0	0	0	0	0	0	0	0	1	1	1	1	1	1
	Cyan	0	0	0	0	0	0	1	1	1	1	1	1	1	1	1	1	1	1
	Magenta	1	1	1	1	1	1	0	0	0	0	0	0	1	1	1	1	1	1
	Yellow	1	1	1	1	1	1	1	1	1	1	1	1	0	0	0	0	0	0
	White	1	1	1	1	1	1	1	1	1	1	1	1	1	1	1	1	1	1
Red	Black	0	0	0	0	0	0	0	0	0	0	0	0	0	0	0	0	0	0
	Red(62)	0	0	0	0	0	1	0	0	0	0	0	0	0	0	0	0	0	0
	Red(61)	0	0	0	0	1	0	0	0	0	0	0	0	0	0	0	0	0	0
	:	:	:	:	:	:	:	:	:	:	:	:	:	:	:	:	:	:	:
	Red(31)	0	1	1	1	1	1	0	0	0	0	0	0	0	0	0	0	0	0
	:	:	:	:	:	:	:	:	:	:	:	:	:	:	:	:	:	:	:
	Red(1)	1	1	1	1	1	0	0	0	0	0	0	0	0	0	0	0	0	0
	Red(0)	1	1	1	1	1	1	0	0	0	0	0	0	0	0	0	0	0	0
Green	Black	0	0	0	0	0	0	0	0	0	0	0	0	0	0	0	0	0	0
	Green(62)	0	0	0	0	0	0	0	0	0	0	0	1	0	0	0	0	0	0
	Green(61)	0	0	0	0	0	0	0	0	0	0	1	0	0	0	0	0	0	0
	:	:	:	:	:	:	:	:	:	:	:	:	:	:	:	:	:	:	:
	Green(31)	0	0	0	0	0	0	0	1	1	1	1	0	0	0	0	0	0	0
	:	:	:	:	:	:	:	:	:	:	:	:	:	:	:	:	:	:	:
	Green(1)	0	0	0	0	0	0	1	1	1	1	1	0	0	0	0	0	0	0
	Green(0)	0	0	0	0	0	0	1	1	1	1	1	1	0	0	0	0	0	0
Blue	Black	0	0	0	0	0	0	0	0	0	0	0	0	0	0	0	0	0	0
	Blue(62)	0	0	0	0	0	0	0	0	0	0	0	0	0	0	0	0	0	1
	Blue(61)	0	0	0	0	0	0	0	0	0	0	0	0	0	0	0	0	1	0
	:	:	:	:	:	:	:	:	:	:	:	:	:	:	:	:	:	:	:
	Blue(31)	0	0	0	0	0	0	0	0	0	0	0	0	0	1	1	1	1	1
	:	:	:	:	:	:	:	:	:	:	:	:	:	:	:	:	:	:	:
	Blue(1)	0	0	0	0	0	0	0	0	0	0	0	0	1	1	1	1	1	0
	Blue(0)	0	0	0	0	0	0	0	0	0	0	0	0	1	1	1	1	1	1

0 : Low level voltage, 1 :High level voltage

Each basic color can be displayed in 64 gray scales from 6 bit data signals. With the combination of total 18 bit data signals, the 262,144-color display can be achieved on the screen.

7. Projected Capacitive Touch Panel**7.1 Main Feature**

Item	Specification	Unit
Screen Size	10.4 inches	Diagonal
Type	Projected Capacitive Touch Panel	--
Input Mode	Human's Finger or Through a special stylus	--
Active Area	213.20 x 160.90	mm
Module Outline	259.20 x 206.40 x 2.00	mm
Interface	USB	--
Touch Function	4	points
Digital Power Supply	5V DC	V

7.2 Pin Assignment for CTP (User Part No.:5F2.2535E-A3821.110 or equivalent.)

Pin No.	Symbol	I/O	Function	Remark
1	GND	P	Ground	
2	NC	-	No Connect	
3	NC	-	No Connect	
4	NC	-	No Connect	
5	NC	-	No Connect	
6	NC	-	No Connect	
7	GND	P	Ground	
8	D+	-	USB D+	
9	D-	-	USB D-	
10	VBUS	-	Power Supply for CTP	

8. Reliability Condition

No change on display and in operation under the following test condition.

Condition: Unless otherwise specified, tests will be conducted under the following condition.

Temperature: 20±5°C.

Humidity: 65±5%RH.

Tests will be not conducted under functioning state.

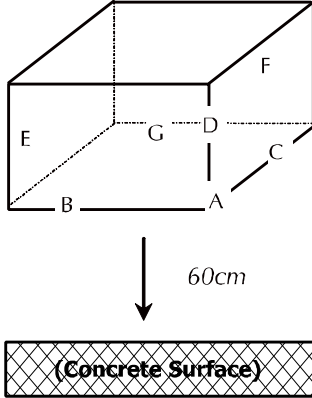
No.	Parameter	Condition	Notes
1	High Temperature Operating	70°C±2°C, 240hrs (Operation state).	
2	Low Temperature Operating	-20°C±2°C, 240hrs (Operation state).	1
3	High Temperature Storage	80°C±2°C, 240hrs.	2
4	Low Temperature Storage	-30°C±2°C, 240hrs.	1,2
5	High Temperature and High Humidity Operation Test	60°C±2°C, 90%, 240hrs.	1,2
6	Vibration Test	Total fixed amplitude: 1.5mm. Vibration Frequency: 10~55Hz. One cycle 60 seconds to 3 direction of Random each 15 minutes.	3
7.	Drop Test	To be measured after dropping from 60cm high on the concrete surface in packing state.  <p><i>Dropping method corner dropping:</i></p> <p><i>A corner: Once edge dropping.</i></p> <p><i>B, C, D edge: Once face dropping.</i></p> <p><i>E, F, G face: Once.</i></p>	

- Notes:
1. No dew condensation to be observed.
 2. The function test shall be conducted after 4 hours storage at the normal temperature and humidity after removed from the test chamber.
 3. Vibration test will be conducted to the product itself without putting I in a container.

9. Dimensional Outlines

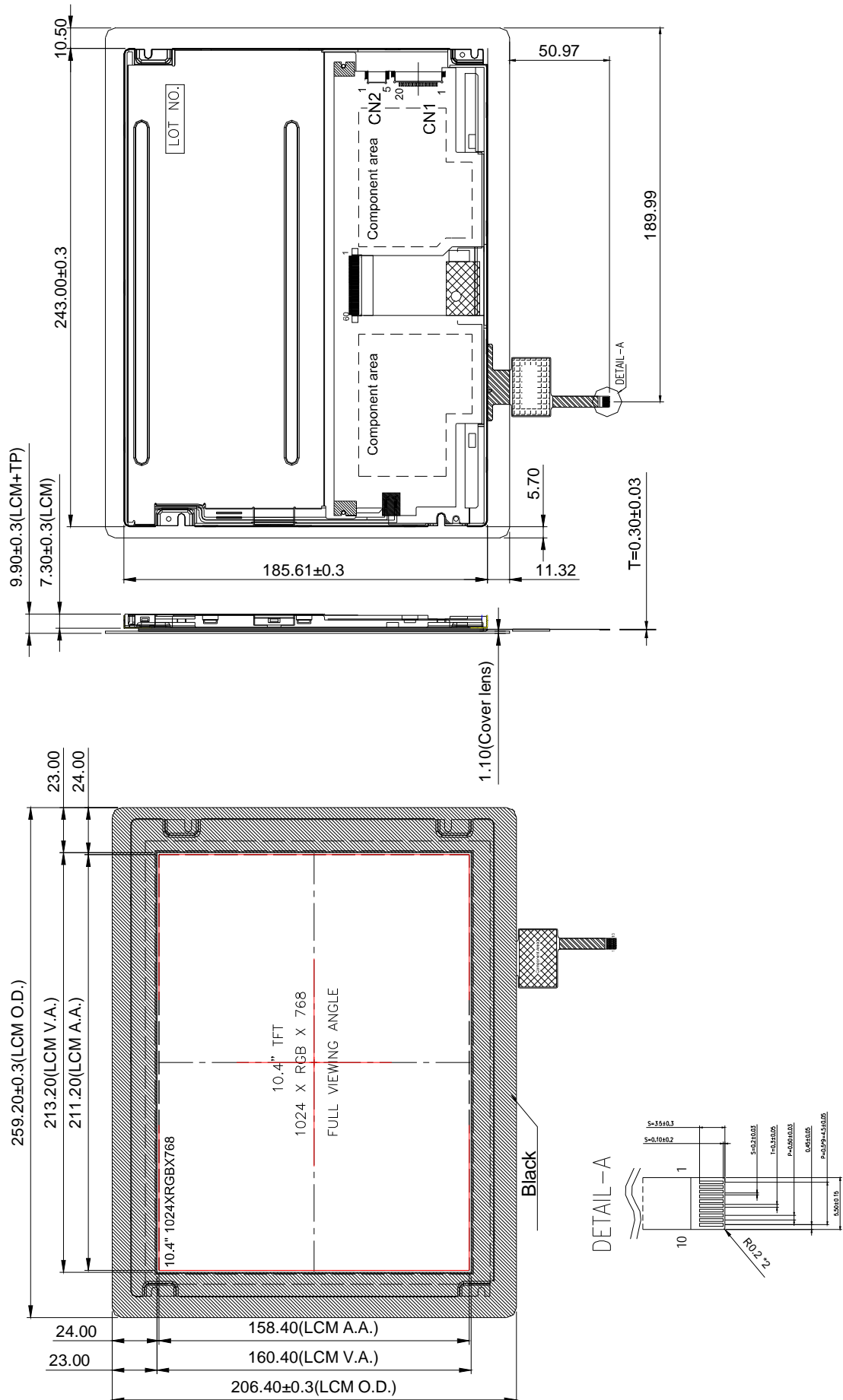

10. Incoming Inspection Standards

10.1 Inspection and Environment Conditions

10.1.1 Inspection Conditions:

- (1) Inspection Distance: 35 cm±5cm
- (2) View Angle : Light-on Inspection Angle : ±5°
Cosmetic Inspection Angle : ±45°

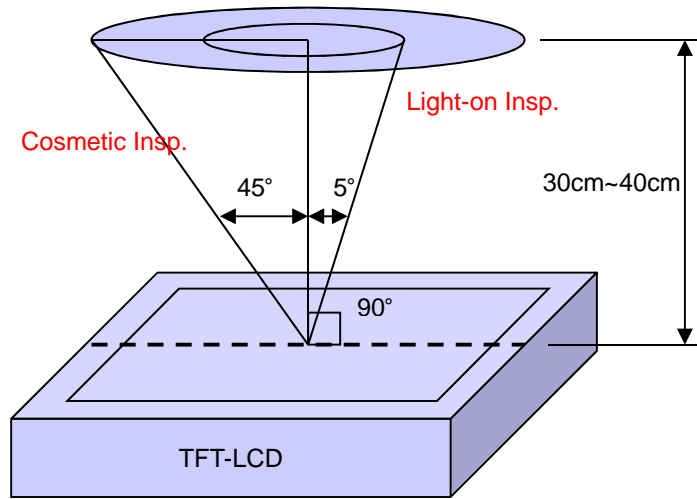

(perpendicular to LCD panel surface)

10.1.2 Environment Conditions:

Ambient Temperature		23°C ±5°C
Ambient Humidity		55±10%RH
Ambient Illumination	Cosmetic Inspection	more than 600 Lux
	Functional Inspection	300~500 Lux

10.1.3 Sampling Conditions:

- (1) Lot Size: Quantity of shipment lot per model
- (2) Sampling Method:

Sampling Plan		MIL-STD-105E
		Normal Inspection, Single Sampling
		Level II
AQL	Major Defect	1.0%
	Minor Defect	1.5%

- (3) The classification of Major(MA) and Minor(MI) defects is shown as 3. Inspection Criteria.

10.1.4 Inspection Criteria

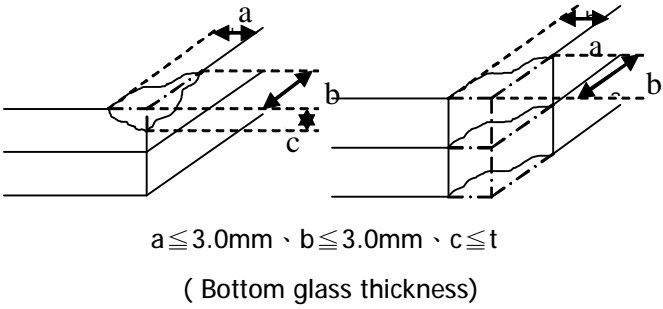
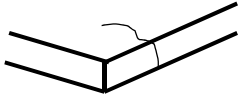

10.1.4.1 Cosmetic Inspection(Panel):

Item	Judgment Criteria	Classification
Chipping on Panel	 <p>$a \leq 3.0\text{mm}$、$b \leq 3.0\text{mm}$、$c \leq t$ (Bottom glass thickness)</p>	MA
Scratch on Panel *Note-2	<p>$W \leq 0.05\text{mm}$ or $L < 5\text{mm}$: Ignored $0.05\text{mm} < W \leq 0.1\text{mm}$ and $L \leq 5\text{mm}$: $N \leq 5$ $W > 0.1\text{mm}$ or $L > 5\text{mm}$: Not allowed</p>	MI
Bubble or Dent on Panel *Note-3	<p>$D \leq 0.2\text{mm}$: Ignored $0.2\text{mm} < D \leq 0.3\text{mm}$: $N \leq 5$ $D > 0.3\text{mm}$: Not allowed</p>	MI
Panel Crack	 <p>Not Allowed crack</p>	MA
Bezel Deformation	Obvious deformation is not allowed.	MI
Bezel Oxidation	Not allowed if it rusts continuously over 1 cm (It is out of warranty with rusted tin plate)	MI
Bezel Scratch	$L \leq 20\text{mm}$, $W \leq 0.2$, $N \leq 3$	MI
Metal Squash Dent /Flange(Front Side)	$D(W) \leq 1, L \leq 3, N \leq 3;$	MI
B/L High Voltage Wire Denudation	Not allowed	MA
Polarizer Flaw or Leak out Resin	Defect is defined as the active area.	MI
Outline Dimension	Must in Spec, refer to related product spec.	MI
Mura & Leak	ND5%	

10.1.4.2 Functional Inspection:

Item	Judgment Criteria			Classification
	Area(Note1)	I	O	
Point Defect	Bright dot	Random	2	
		2 dots adjacent	0	0
		3 dots adjacent or more	0	0
	Dark dot	Random	3	
		2 dots adjacent	0	
		3 dots adjacent or more	0	0
	Total Dot Defect		5	
	Distance	Distance between Bright and Bright dot	$L \geq 5\text{mm}$	
		Distance between Bright and Dark dot	$L \geq 5\text{mm}$	
		Distance between Dark dot	$L \geq 50\text{mm}$	
(1) It is defined as Point Defect if defect area $> 0.5\text{dot}$ (2) It is ignored if defect area $\leq 0.5\text{dot}$ (3) Weak point defect will be defined as Bright Dot if it can be observed through ND filter 5% (Full Screen Black Inspection)				
Line Defect	Obvious vertical or horizontal line defect is not allowed.			MA
Mura	Not allowed if it can be observed through ND Filter 5 %			MI
Foreign Material in spot shape *Note-3	$D \leq 0.2\text{mm}$: Ignored $0.2\text{mm} < D \leq 0.5\text{mm}$: $N \leq 8$ $D > 0.5\text{mm}$: Not allowed			MI
Foreign Material in line or spiral shape *Note-4	$W \leq 0.05\text{mm}$ or $L \leq 5\text{mm}$: Ignored $0.05\text{mm} < W \leq 0.2\text{mm}$ and $L 1.0\text{mm} \leq 5\text{mm}$: $N \leq 8$ $W > 0.2\text{mm}$ or $L > 5\text{mm}$: Not allowed			MI
Display Function Abnormal	No Malfunction can be allowed			MA

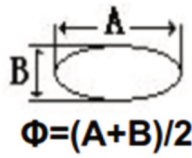
10.1.4.3 Appearance inspection (Touch Panel)

Item	Judgment Criteria	Classification
Dots defects	1. $D \leq 0.2\text{mm}$, Ignored ' Pass 2. $0.2\text{mm} < D \leq 0.35\text{mm}$, $DS > 10\text{mm}$, $N \leq 3$, Ignored' Pass 3. $D > 0.35\text{mm}$ ' Not allowed	
Scratch	1. $W < 0.03\text{mm}$, $L \leq 10\text{mm}$ Ignored' Pass 2. $0.03\text{mm} \leq W \leq 0.05\text{mm}$, $L < 5\text{mm}$ $DS > 10\text{mm}$, $N \leq 3$, Ignored' Pass $L > 5\text{mm}$ ' Not allowed 3. $W > 0.05\text{mm}$ ' Not allowed	

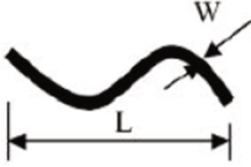
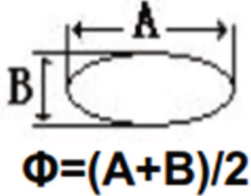
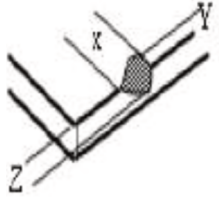
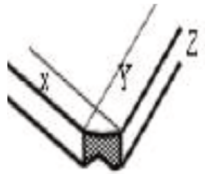
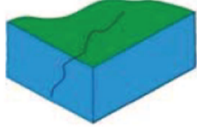
<p>Linear defects</p>	<p>1. $W < 0.25\text{mm}$, Ignored ' Pass 2. $L < 2\text{mm}$, $DS > 10\text{mm}$, $N \leq 2$, Ignored ' Pass 3. $0.035\text{mm} \leq W \leq 0.05\text{mm}$, $L < 2\text{mm}$, $N \leq 1$, Ignored ' Pass $L > 2\text{mm}$, $N > 2$ ' Not allowed 4. $W > 0.05\text{mm}$ ' Not allowed</p>	
<p>Concave /Convex / Bubbles</p>	<p>1. $D < 0.2\text{mm}$, $N \leq 2$, $DS > 10\text{mm}$ Ignored ' Pass 2. $0.2\text{mm} < D \leq 0.35\text{mm}$, $N \leq 2$, Ignored ' Pass 3. $D > 0.35\text{mm}$ ' Not allowed</p>	
<p>Edge broken loss</p>	<p>1. $X \leq 2\text{mm}$, $Y \leq 1\text{mm}$, $Z \leq t$ (t = glass thickness), without affecting the function of the product, it is disregard. 2. If the edge fault is located on a golden finger or line, it seriously affects the function of the product, the product is NG. X: Length ; Y: Width ; Z: Glass Thickness</p>	
<p>Corner broken loss</p>	<p>1. $X \leq 1.5\text{mm}$, $Y \leq 1\text{mm}$, $Z \leq t$ (t = glass thickness), without affecting the function of the product, it is disregard. 2. If the edge fault is located on a golden finger or line, it seriously affects the function of the product, the product is NG. X: Length ; Y: Width ; Z: Glass Thickness</p>	
<p>Crack</p>	<p>Not allowed: no matter in what position.</p>	

Item	Judgment Criteria
Smudge	Can wipe clean part that judged to be OK.
Color/ Logo/ Typeface of cover lens ; shade of background	Color shows no difference from that of the samples.
	Uniform and clear typeface, clear pattern.
	Good shade of background color.
	Less than 0.3mm tolerance is allowed.

Note-1 : I/O Area Definition

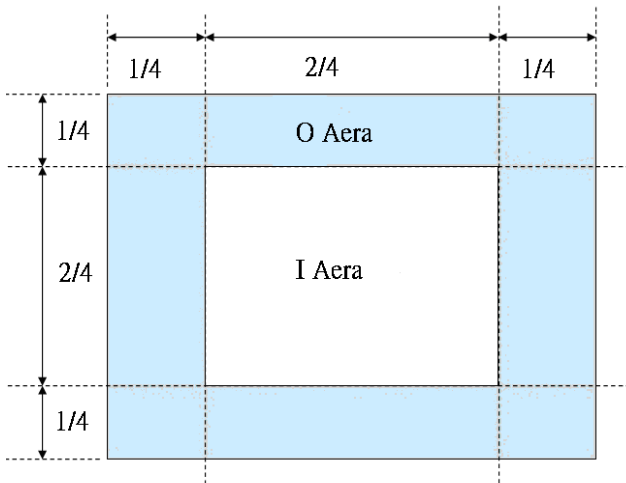

Note-2 : Polarizer Scratch

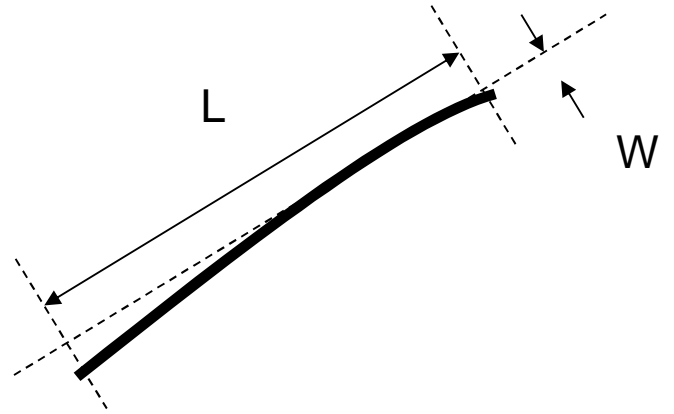

Note-3 : Spot Foreign Material
($W \geq L / 4$)

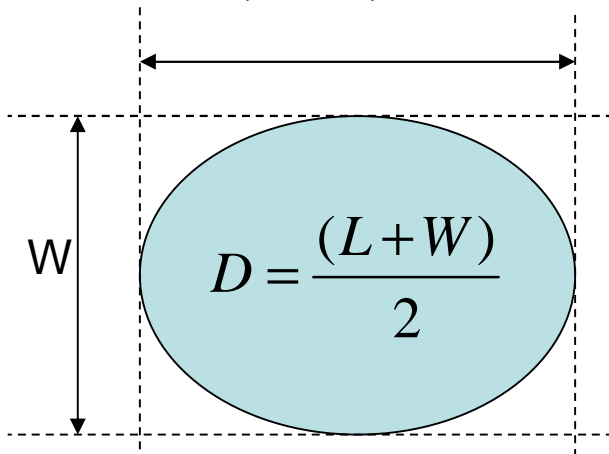

Note-4 : Line or Spiral Foreign Material
($W < L / 4$)

