

GP Batteries

Data Sheet

Model No.: CR1220

Description : Flat Lithium Battery
 Chemical system : Lithium Manganese Dioxide
 Nominal voltage : 3 Volts
 Nominal capacity : 36mAh
 Dimensions : $\phi 12.5 \times 2.0$ mm
 Shelf life : 5 years at room temperature
 Average weight : 0.8 grams
 Applications : watch, calculator, camera and memory back up.

Discharge Characteristics on load

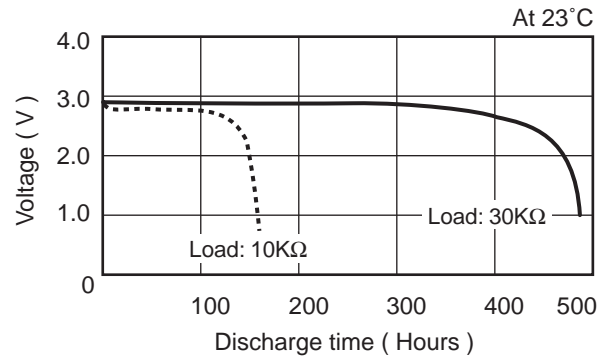

Discharge characteristics on temperature

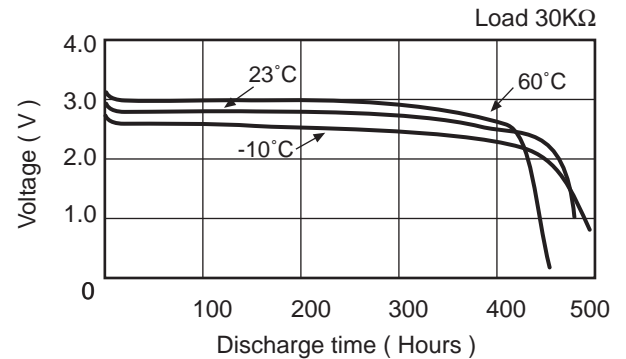

Discharge characteristics on pulse load

(Discharge depth 40%)
 Excellent low-impedance characteristics

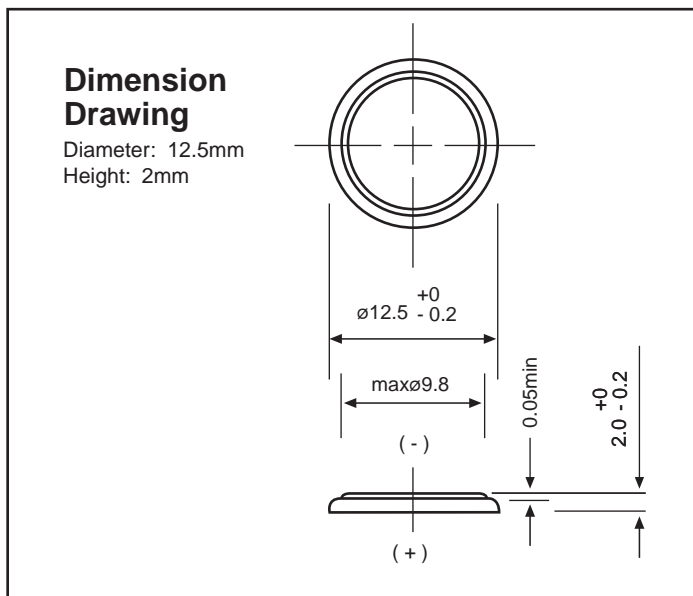
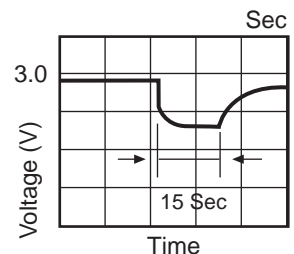
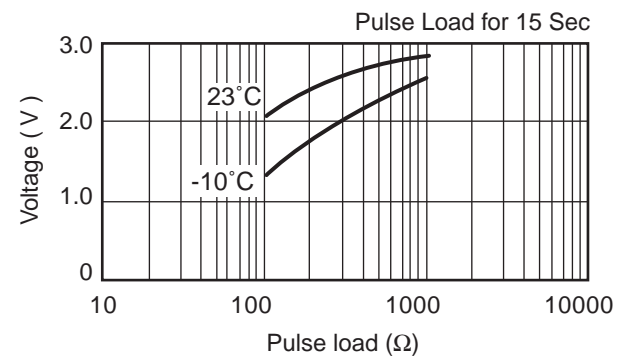

Discharge load vs Discharge capacity

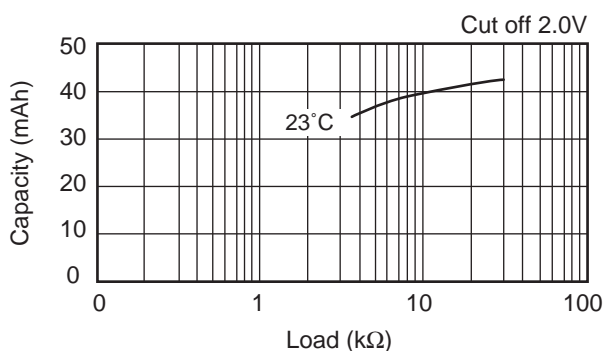

Cross Reference:

IEC	JIS	Eveready	Varta
CR1220	CR1220	ECR1220	CR1220