



FEATURES

- ◆ LED DIMMER
- ◆ Power input: 12-24-48 Vdc
- ◆ Voltage output for LED strips and LED modules
- ◆ WHITE and MONOCHROME Light Control
- ◆ Device configuration using Dalcnet LightApp mobile application
- ◆ Local Command:
 - N°1 button normally open
 - 0-10V
 - 1-10V
 - Potentiometer 10KOhm
- ◆ Constant voltage outputs for resistive loads
- ◆ PWM modulation
- ◆ PWM frequency can be set by APP
- ◆ Adjustment curve adjustable by APP
- ◆ Soft power on and off
- ◆ Extended temperature range
- ◆ 100% Functional Test

PRODUCT DESCRIPTION

The MINI-1CV is a single-channel LED dimmer, controllable locally with a normally open button, a 0-10V/1-10V signal or potentiometer.

The LED dimmer is suitable for driving loads such as LED strips and LED modules, White and single-color constant voltage. It is possible to connect a power supply at 12-24-48 Vdc.

The maximum value of the output current is 12A. The LED dimmer has the following protections: over-power protection, under-power protection, reverse polarity protection and input fuse protection.

Using the Dalcnet LightApp mobile application you can configure multiple parameters of the MINI-1CV such as Dimming frequency, Dimming curve, max and min brightness level, etc. It also allows you to configure from simple brightness adjustments up to 10 scenarios or dynamic animations.

LightApp is free to download from the Apple App Store and Google Play Store.

→ For the always updated manual, consult our website: www.dalcnet.com or QR Code



PRODUCT CODE

CODE	POWER SUPPLY	OUTPUT LED	N° OF CHANNEL	ANALOGIC AUTOMATIC DETECTION	APP CONFIG
MINI-1CV	12-24-48 VDC	1 x 12A ¹	1	N°1 Push N.A. 0-10V 1-10V Potentiometer 10kOhm	APP: LIGHT APP

PROTECTIONS

OVP	Over-voltage protection ²	✓
UVP	Under-voltage protection ²	✓
RVP	Reverse polarity protection ²	✓
IFP	Protection with input fuse ²	✓

REFERENCE STANDARDS

EN 55015	Limits and methods of measurement of radio disturbance characteristics of electrical lighting and similar equipment
EN 61547	Equipment for general lighting purposes – EMC immunity requirement
EN 61347-1	Lamp Controlgear – Part 1: General and safety requirement
EN 61347-2-13	Lamp Controlgear – Part 2-13: Particular requirement for d.c. or a.c. supplied electronic Controlgear for LED modules

¹ The maximum output current depends on the operating conditions and the ambient temperature of the installation. For the correct configuration, check the maximum power that can be delivered in the "[Technical Specifications](#)" section and the "[Thermal Characterization](#)".

² Protections refer to the control logic of the board.

TECHNICAL SPECIFICATIONS

		MINI 1 CV
Supply voltage		Min: 10,8Vdc – Max: 52,8Vdc
Output voltage		=Vin
Input current		Max 12A
Output current⁴		max 12A @30°C – max 10A @45°C – max 8A @60°C
Nominal power	12 Vdc	144W @12A – 120W @10A – 96W @8A
	24 Vdc	288W @12A – 240W @10A – 192W @8A
	48 Vdc	576W @12A – 480W @10A – 384W @8A
Power loss in standby mode		< 0,5W
Type of load⁵		R
Dimming curve		Logarithmic – Linear – Quadratic
Dimming range⁷		Pulse Width Modulation "PWM"
PWM resolution⁷		300 – 660 – 1300 – 2000 – 4000 Hz
Storage temperature		Min: -40°C – Max: 60°C
Ambient temperature, Ta range⁴		Min: -10°C – Max: 60°C
Type of connector		Screw terminals
Wiring	Solid Size	0,05 ÷ 2,5 mm ² / 30 ÷ 12 AWG
	Stranded size	
Wire strip length		6,5 mm
IP protection grade		IP20
Casing material		Plastic
Packaging unit (pieces/unit)		1pz
Mechanical dimension		44 x 57 x 25 mm
Packaging dimension		56 x 68 x 35 mm
Weight		47g

WIRING DIAGRAM

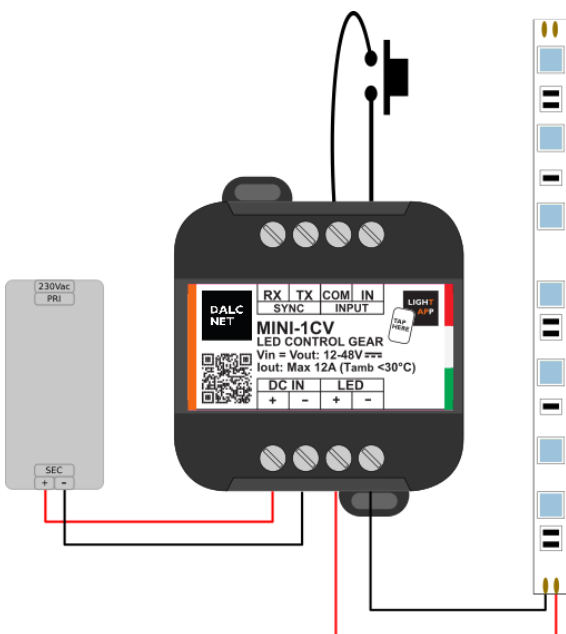

As shown in the connection diagram, perform the following steps to install the product:

- ◆ Connect the LED load to the "LED" terminal respecting the indicated polarity.
- ◆ Local command wiring:
 - Connect the normally open button to the "INPUT" terminals with the "COM" and "IN" symbols. Be sure not to connect live parts to the "INPUT" terminals.
 - Connect the positive control of the 0/1-10V signal to the "INPUT" terminal with the "IN" symbol, instead the negative of the 0/1-10V signal to the "INPUT" terminal with the "COM" symbol.
 - Connect the 10KOhm potentiometer to the "INPUT" terminals with the symbols "COM" and "IN". Be sure not to connect live parts to the "INPUT" terminals.
- ◆ Connect a constant voltage SELV power supply 12-24-48 Vdc (depending on the LED load plate data) to the DC IN terminal respecting the indicated polarity. Make sure you are not using a power supply with a constant current output and check that the polarity of the cables is correct.

⁴ For the complete range or check the [Thermal Characterization](#) of the product.

⁵ Type of load: Resistive and DC/DC Converter.

⁷ The parameters are derived from the configuration of the LIGHTAPP.

LOCAL COMMAND FUNCTIONALITY

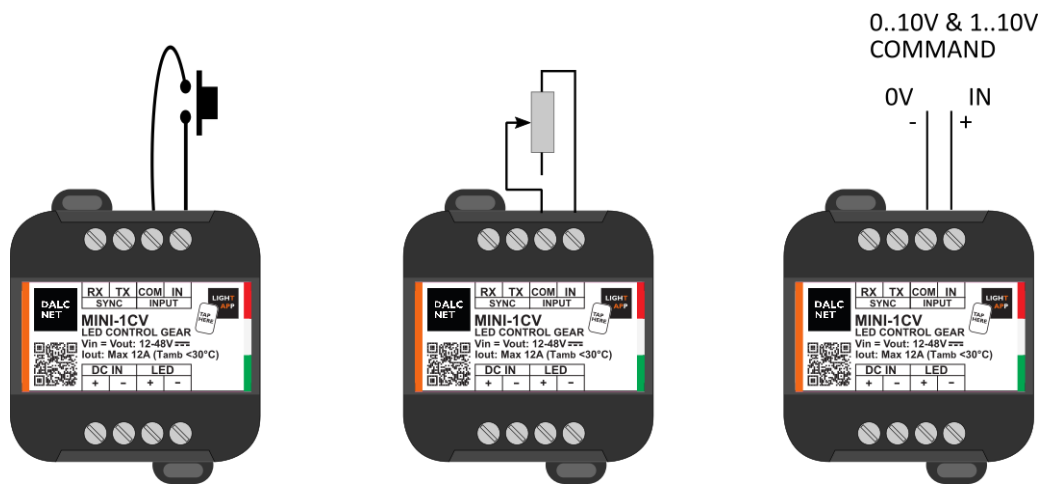

AUTOMATIC RECOGNITION OF LOCAL COMMAND

At the first power on, by default the device is set to automatically recognize the N.A button.

AUTOMATIC RECOGNITION OF 0-10V / 1-10V / POTENTIOMETER MODE

If a 0-10V/1-10V command or a 10kOhm potentiometer is connected, a quick change in the signal or potentiometer adjustment is sufficient for the device to recognize the new type of command.

During operation in 0-10V / 1-10V / Potentiometer mode, the parameters that can be set via app will be only the dimming curve and the PWM frequency. All other parameters set for push-button operation will be ignored in this mode.

AUTOMATIC BUTTON MODE RECOGNITION

If an N.A. button is connected, 5 quick presses are sufficient for the device to recognize the new type of command.

MASTER & SLAVE CONNECTION

SYNC DEVICES WITH A SINGLE POWER SUPPLY

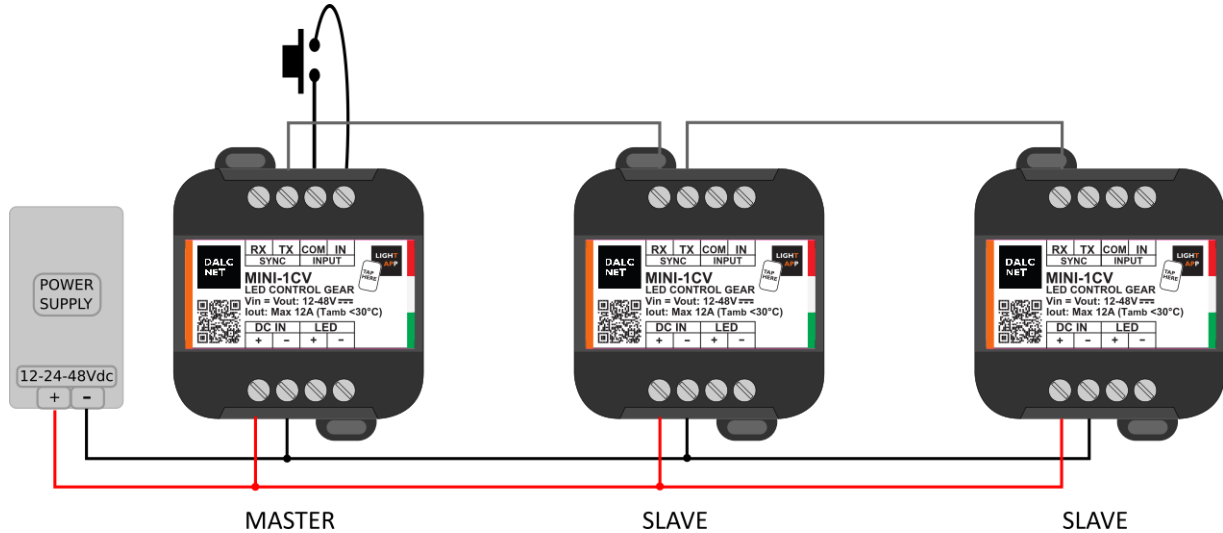

DEVICE SYNCHRONIZATION, A DIMMER POWER SUPPLY

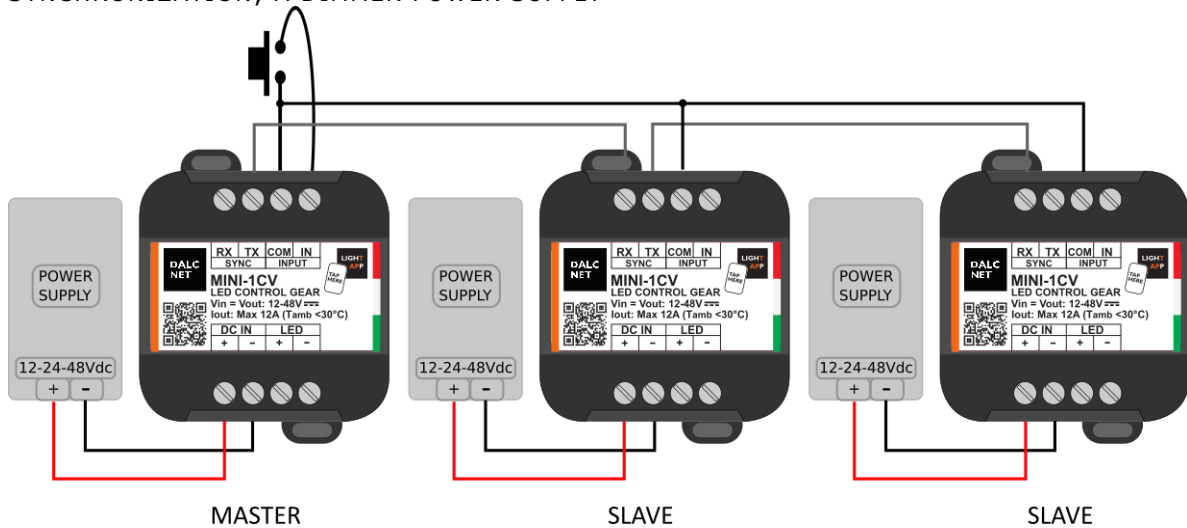

SYNCHRONIZATION FUNCTION

You can connect the various devices in the Master & Slave configuration.

Attach the desired local command to the device you want to configure as Master.

To send the synchronization signal between Master and Slave, make the connection between the "SYNC" terminal with the "TX" symbol of the device configured as Master and the "SYNC" terminal with the "RX" symbol of the device configured as Slave.

To transmit the synchronization signal to the second Slave, make the connection between the "SYNC" terminal with the "TX" symbol of the first device configured as a Slave and the "SYNC" terminal with the "RX" symbol of the second device configured as Slave. All devices configured as Slaves are disabled the inputs "INPUT"

You can configure a Master & Slave system up to a maximum of 10 total devices.

ATTENTION:

- ◆ A device connected as Slave will remain configured as Slave until the next reboot.
- ◆ On every device, the dimming curve will remain the one selected by the user via APP on the Master device, whether it is Master or Slave.

OPERATING WINDOWS

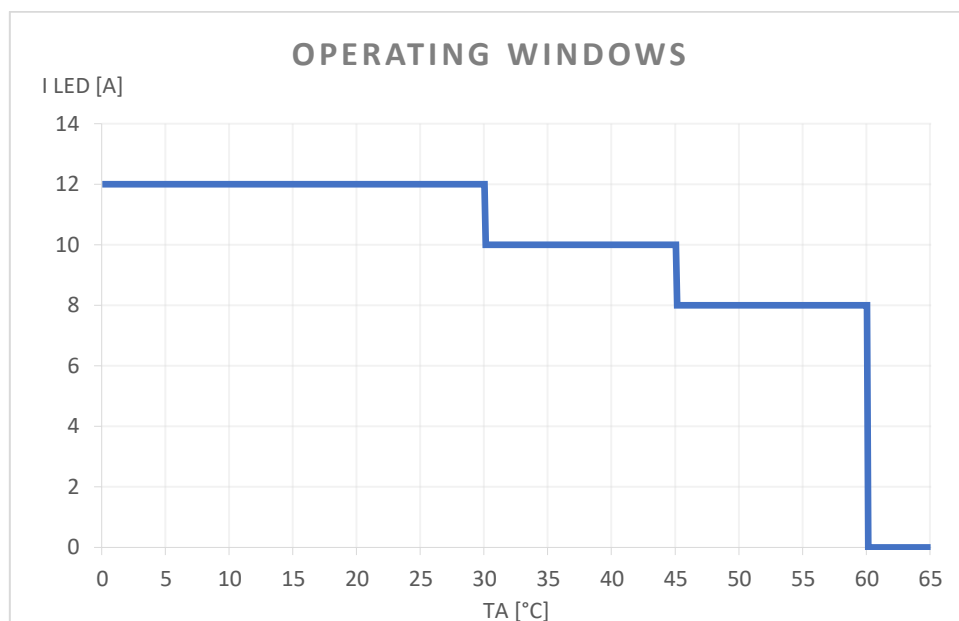

Below are the maximum current values that can be supplied by the MINI-1CV device when the working temperature varies. Ambient temperature [Ta]:

- ◆ - 10°C ÷ +30°C; Maximum current 12A
- ◆ +30°C ÷ +45°C; Maximum current 10A
- ◆ +45°C ÷ +60°C; Maximum current 8A

These maximum current values can be applied only under proper ventilation conditions.

FLICKER PERFORMANCE

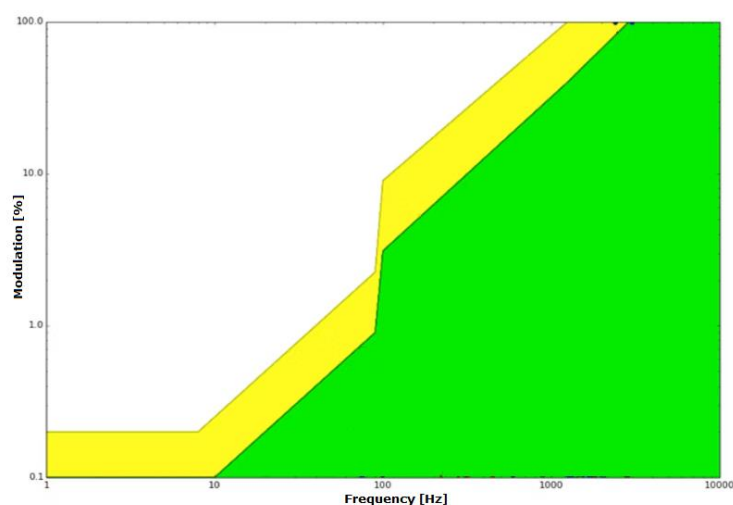

Thanks to the 4kHz dimming frequency the MINI-1CV allows to reduce the Flicker phenomenon.

Depending on the sensitivity of a person and the type of activity, flickering can affect a person's well-being even if the luminance fluctuations are above the threshold that can be perceived by the human eye.

The graph shows the phenomenon of Flickering in function at the frequency, measured throughout the dimming range.

The results show the low-risk zone (yellow) and the no-effect zone (green). Defined by IEEE 1789-2015⁹

⁹ Institute of Electrical and Electronics Engineers (IEEE). *IEEE std 1789: Recommended Practices for Modulating Current in High-Brightness LEDs for Mitigating Health Risks to Viewers.*

DIMMING CURVE

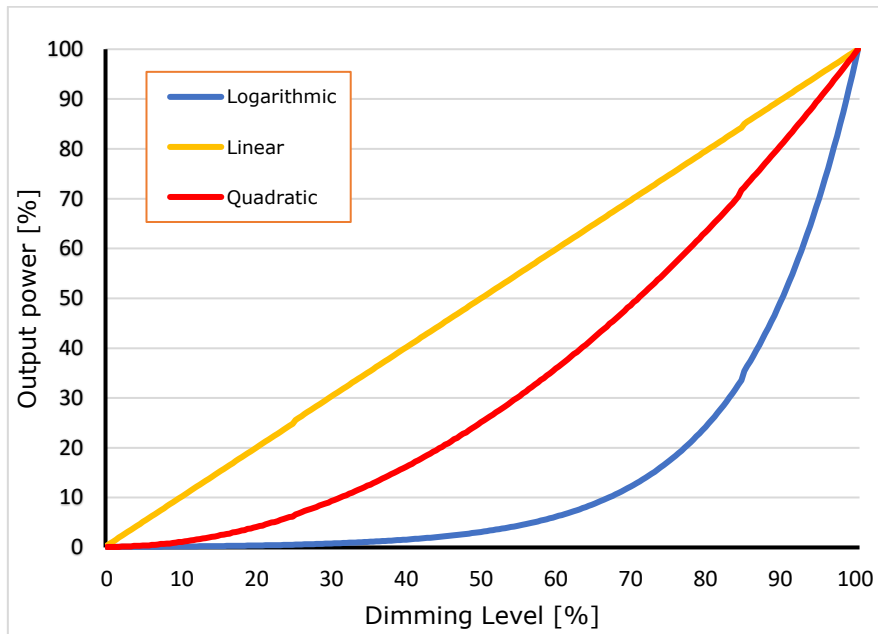

MECHANICAL DIMENSIONS

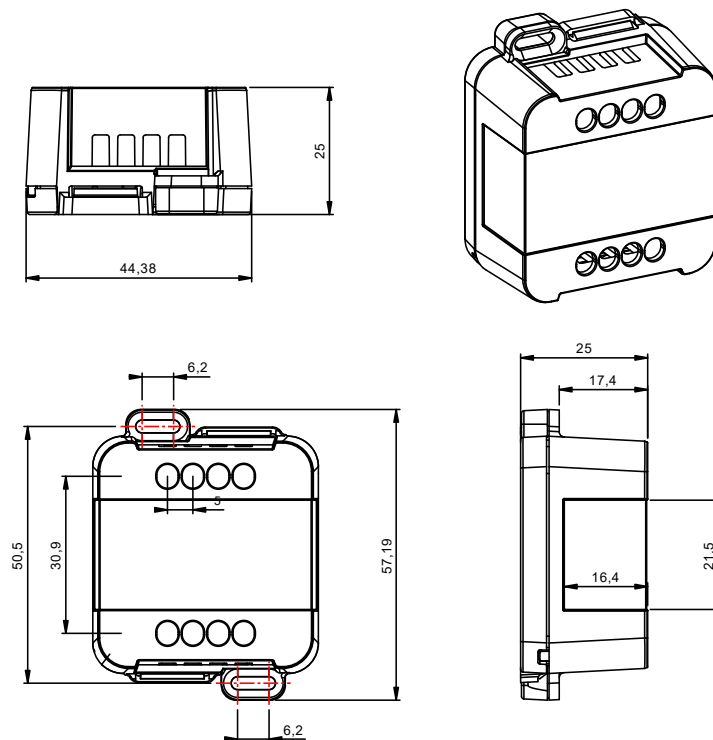

TECHNICAL NOTE

INSTALLATION

- CAUTION: The product may only be connected and installed by a qualified electrician. All applicable regulations, legislation, and building codes must be observed. Incorrect installation of the product can cause irreparable damage to the product and the connected LEDs.
- Maintenance must be performed only by a qualified electrician in compliance with current regulations.
Pay attention when connecting the LEDs: polarity reversal results in no light output and often damages the LEDs.
- The product is designed and intended to operate LED loads only. Powering non-LED loads may push the product outside its specified design limits and is, therefore, not covered by any warranty.
Operating conditions of the product may never exceed the specifications as per the product datasheet.
- The product must be installed inside a switchgear/controlgear cabinet and/or junction box protection against overvoltage.
- The product must be installed in a vertical or horizontal position with the label/top cover facing upwards or vertically. Other positions are not permitted. The bottom position is not permitted (label/top cover facing down).
- Keep separated 230Vac (LV) circuits and not SELV circuit from safety extra low voltage (SELV) circuit and from any connection with this product. It is absolutely forbidden to connect, for any reason whatsoever, directly or indirectly, the 230Vac mains voltage to the product (terminal block of BUS included).
- The product must be dissipated correctly.
- The use of the product in harsh environments could limit the output power.
- For built-in components inside luminaires, the ta ambient temperature range is a guideline given for the optimum operating environment. However, integrator must always ensure proper thermal management (i.e. correct mounting of the device, air flow etc.) so that the tc point temperature does not exceed the tc maximum limit in any circumstance. Reliable operation and lifetime are only guaranteed if the maximum tc point temperature is not exceeded under the conditions of use.

POWER SUPPLY

- Only use SELV power supplies with limited current for device power supply, short circuit protection and the power must be dimensioned correctly.
In the case of power supplies equipped with ground terminals, it is mandatory to connect ALL protective ground points (PE= Protection Earth) to a properly and certified protection earth.
- The connection cables between the very low voltage power source and the product must be properly dimensioned and must be insulated from any wiring or part at non-SELV voltage. Use double insulated cables.
- Dimension the power of the power supply in relation to the load connected to the device. In case the power supply is oversized compared to the maximum absorbed current, insert a protection against over-current between the power supply and the device.

COMMAND

- The length of the cables connecting between the local commands (N.O. Push button or other) and the product must be less than 10m. The cables must be properly dimensioned and must be insulated from any non-SELV wiring or voltage. It is recommended to use double insulated cables, if deemed appropriate also shielded.
- ALL device and control signal connected to the local command "N.O. Push button" with  symbol, they must not supply any type of voltage.
- ALL device and control signal connect to the local command (0-10V, 1-10V, potentiometer or other) must be SELV type (the device connected must be SELV or supply SELV signal).

OUTPUTS

- It is recommended a length of the connecting cables between the product and the LED module less than 10m. The cables must be properly dimensioned and must be insulated from any wiring or circuits at voltage not SELV. It is recommended to use double insulated cables. In case you want to use connecting cables between the product and the LED module greater than 10m, the installer must guarantee the correct operation of the system. In any case, the connection between the product and the LED module must not exceed 30m.

LIGHTAPP

START UP AND FIRST INSTALLATION

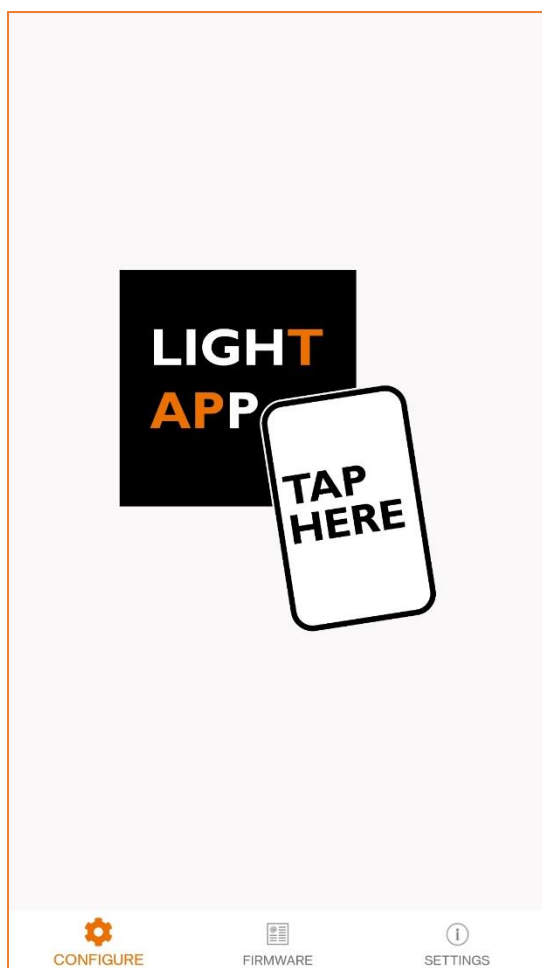

START SCREEN

On this screen, the app waits for the device parameters to be read.

To read the parameters, simply bring the back of the smartphone close to the device label. The read-sensitive area of the smartphone may vary depending on the model.

Once the connection is established, a quick loading screen will appear. It is necessary to stay in place with the smartphone until the parameters are fully loaded.

iOS variant: to read the parameters you need to press the SCAN button at the top right. A pop-up will appear indicating when the smartphone is ready to scan. Move the smartphone close to the device and stay in place until the parameters are fully loaded.

SETTINGS AND FIRMWARE LOADING PAGES



SETTINGS

Application	
Language	English
App version	1.0.0-20220726
Password to write	
The Company	
Address	Via Lago di Garda, Altavilla Vicentina, VI
	www.dalcnet.com

On the settings page you can set:

- ◆ App language
- ◆ Password: to be used for writing parameters.



FIRMWARE

Firmware upload



Choose a new firmware you want to upload to the device

SELECT A FILE

Max 10MB

On the firmware page, you can update the firmware of the device.

The requested file must be of type **.bin**.

Once the file is uploaded, follow the on-screen instructions.

ATTENTION:

- ◆ Once the procedure has begun, it is irrevocable and it is not possible to pause it.
- ◆ In case of interruption the firmware would be corrupted. In this case the device will need to repeat the loading procedure.
- ◆ At the end of the firmware loading, all previously set parameters will be reset to factory values.

If the update is successful and the loaded version is different from the previous one, the device will make 10 flashes

LOADING PARAMETERS

IMPORTANT: The writing of the parameters must be done with the device off (without input power).

WRITE

READ

READ

With the app in READ mode, the smartphone will scan the device and show its current configuration on the screen.

WRITE

With the app in WRITE mode, the smartphone will write the configuration of the parameters set on the screen inside the device.

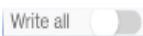
Write all

Write all

In normal mode (*Write All Off*) the app writes only the parameters that have changed since the previous reading. In this mode, writing will only be successful if the serial number of the device matches the one previously read.

Write all

In *Write All* mode, all parameters are written. In this mode, writing will be successful only if the device model matches the one previously read.

It is recommended to activate the *Write All* mode only when you need to replicate the same configuration on many other devices of the same model.



WRITE PROTECTION

Using the padlock button, you can set a block when writing parameters. A screen for entering a 4-character password will appear. Once this password has been written to the device, all subsequent parameter changes can only be made if the correct password is written to the Settings page of the app.

To remove the password lock, simply press the padlock button and leave the Password field blank.

WRITING ERROR

If, after writing the parameters, when you turn it back on, the device flashes 2 times per second continuously, it means that the writing was not successful. Therefore, you need to perform the following steps:

- ◆ Turn off the device.
- ◆ Rewrite the parameters.
- ◆ Wait for the script to be successful or for no error messages to appear.
- ◆ Turn the device back on.

If it does not work, you can perform a factory reset by quickly turning the device off and on 6 times.

PRODUCTION INFORMATION

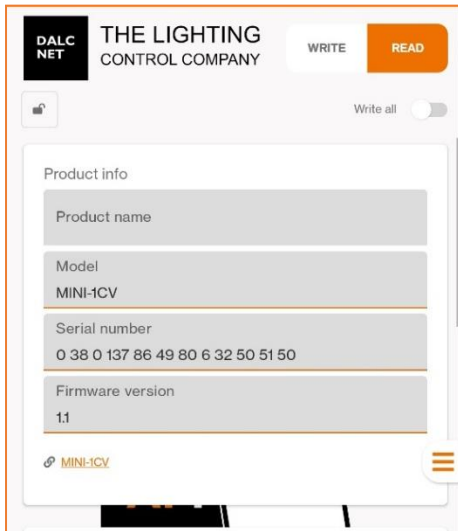

Product Name: User-settable field for easy identification. By default, the product name is the same as the Model field.

Template: An immutable field. Identifies the device model.

Serial number: This field cannot be edited. Uniquely identifies the specimen.

Firmware version: field not editable. Identifies the firmware version currently loaded on the device.

CONTROL SETTINGS

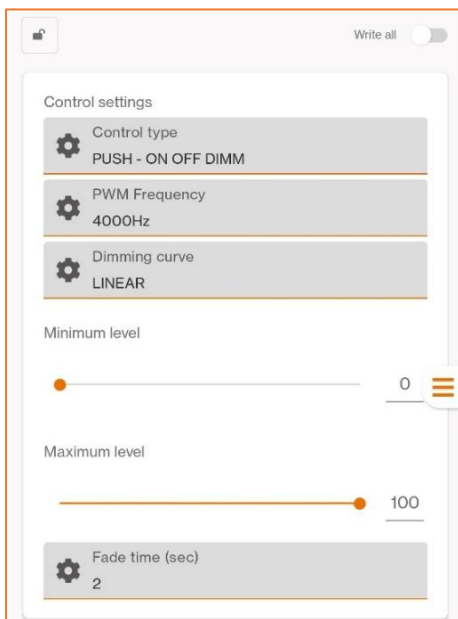

Control type: allows you to set the operating logic of the analog input in case of connection to a button or switch.

PWM frequency: allows you to set the frequency of PWM modulation of the output. NOTE: For applications in harsh thermal conditions, it is advisable to lower the PWM frequency to a minimum (307 Hz)

Dimming curve: For details, see the Dimming Curves section of the device manual

Fade time: The time in seconds that the output takes to make a transition from one level of light intensity to another.

CONTROL TYPES

PUSH – ON OFF DIM

The PUSH ON OFF DIM control type allows on/off and dimming by push-button

- ◆ Quick press: switch from On to Off or vice versa
- ◆ Long press: dimming
- ◆ Quick double press: instant on/off

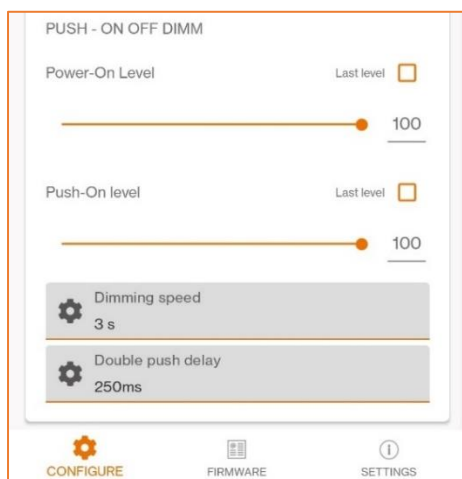

Power On level: it is the intensity value to which the output is brought immediately as soon as the device is powered.

Last level: Enable the memory function. The Power On level will correspond to the last level assumed before the supply voltage was removed.

Push-On level: it is the intensity value to which the output is brought when the device is accessed by means of a button.

Dimming speed: it is the time needed to dim the light from 100% to 0%

Last level: enables the memory function. The power level will correspond to the last level assumed before the device was turned off by button

Double-push delay: allows you to set the speed at which you need to perform the double-quick press.

PUSH – ON OFF

The PUSH ON OFF control type allows on/off via button without dimming

- ◆ Quick press: switch from On to Off or vice versa
- ◆ Long press: no effect
- ◆ Quick double press: instant on/off

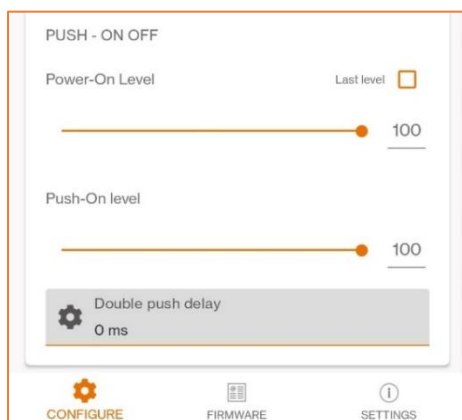

Power-On level: it is the intensity value to which the output is brought as soon as the device is powered.

Last level: enable the memory function. The Power On level will correspond to the last level assumed before the supply voltage was removed

Push-On level: it is the intensity value to which the output is brought when the device is accessed by means of a button

Double-push delay: it allows you to set the speed at which you need to perform the double-quick press

PUSH - SEQUENCE

The PUSH SEQUENCE control type allows you to use a button to switch between different sequential levels of light intensity

- ◆ Quick Press: Move from one Level to the next
- ◆ Long press: no effect
- ◆ Double quick press: return to Power On level. The sequence starts again from the first level.

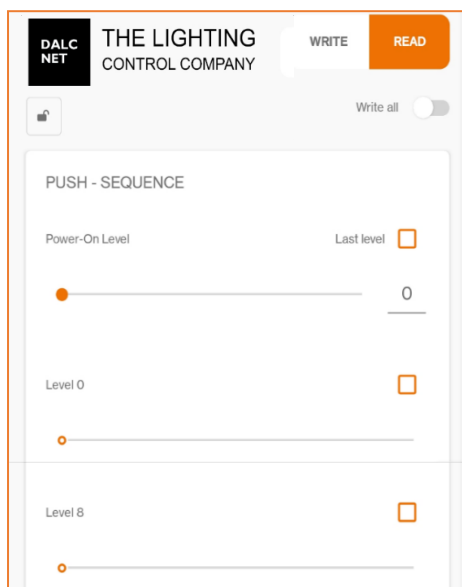

Power On level: it is the intensity value to which the output is brought as soon as the device is powered

Last level: enable the memory function. The Power On level will correspond to the last level assumed before the supply voltage was removed

Levels Setting: you can enable up to a maximum of 10 levels in sequence. To enable a level, simply check the box on the right side and set the light intensity with the slider.

Double-push delay: it allows you to set the speed at which you need to perform the double fast press

PUSH - ANIMATION

The PUSH ANIMATION control type allows you to use a button to control an animation (dynamic scene).

- ◆ Quick press: Animation start/stop
- ◆ Long press: no effect
- ◆ Double quick press: return to Power On level

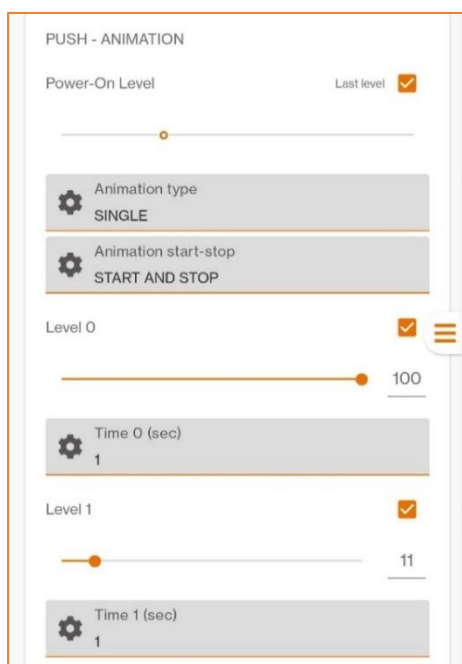

Power On level: is the intensity value to which the output is brought as soon as the device is powered

Last level: enable the memory function. The Power On level will correspond to the last level assumed before the supply voltage was removed

Animation Type

In **SINGLE** mode, when the button is pressed, the animation will be executed only once.

In **CONTINUE** mode, the animation will continue to repeat until the button is turned off/paused.

Animation Start-Stop

In **START** mode, each time the button is pressed, the animation will start from the beginning.

In **START and STOP** mode, pressing the button will alternately start and stop the animation at the current level.

Levels Setting: you can enable up to a maximum of 10 levels in sequence. To enable a level, simply check the box on the right side and set the light intensity with the slider.

You must also set the duration (Time) of each layer within the animation.

Double-push delay: it allows you to set the speed at which you need to perform the double-quick press.

SWITCH – TWO LEVEL

The control type SWITCH TWO LEVELS allows you to alternate two different levels of light intensity through a switch connected to the button input.

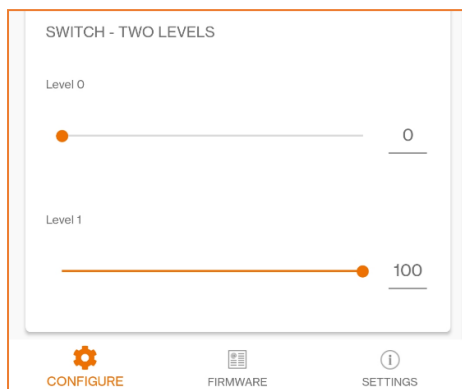

- ◆ When the switch is closed (short circuit) the output will go to Level 0.
- ◆ With the switch open (open circuit) the output will take you to Level 1.

SWITCH - SEQUENCE

The SWITCH SEQUENCE control type allows you to use a switch to switch between different sequential levels of light intensity

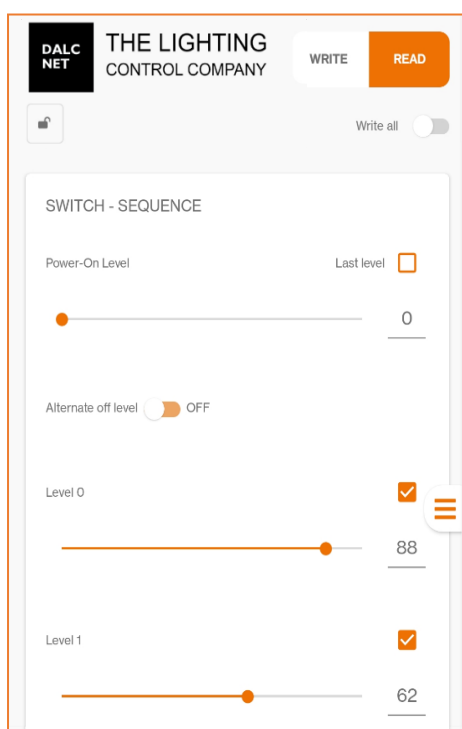

Power-On level: it is the intensity value to which the output is brought as soon as the device is powered if the switch is on ON. If the switch is OFF (open) the light will remain off.

Last level: Enable the memory function. The Power On level will correspond to the last level assumed before the supply voltage was removed

Alternate off level – ON: s and you enable this function between one level and another will always be set a shutdown level. In this way, when the switch is open (Off) the light will always be off. When the switch is closed (On) the light will take on one of the set levels from time to time.

Alternate off level – OFF: sand you disable this function the light intensity will change from one level to the next one with each on-off (open-closed) switch transition.

Setting Levels: you can enable up to a maximum of 10 levels in sequence. To enable a level, simply check the box on the right side and set the light intensity with the slider.

SWITCH - ANIMATION

The ANIMATION SWITCH control type allows you to use a SWITCH to control an animation (dynamic scene).

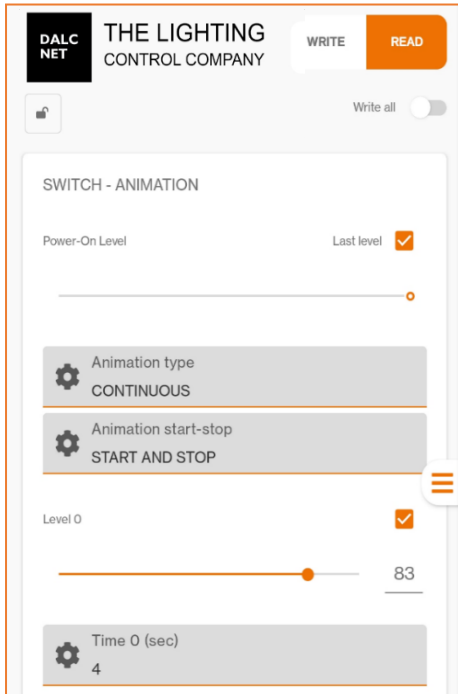

Power On level: it is the intensity value to which the output is brought as soon as the device is powered if the switch is on ON. If the switch is OFF (open) the light will remain off.

Last level: enable the memory function. The Power On level will correspond to the last level assumed before the supply voltage was removed

Animation Type

In **SINGLE** mode when the switch switches to ON, the animation will run only once.

In **CONTINUOUS** mode when the switch switches to ON (closed) the animation will continue to repeat until the switch is turned OFF (open)

Animation Start-Stop

In **START** mode, whenever the switch switches from OFF to ON, the animation starts. When the switch is turned OFF (open) the light turns off.

In **START and STOP** mode, when the switch switches from OFF to ON, the animation starts. When the switch is switched to OFF, the animation stops at the current level, and then starts again at the next switch switch ON.

Setting Levels: you can enable up to a maximum of 10 levels in sequence. To enable a level, simply check the box on the right side and set the light intensity with the slider.

You must also set the duration (Time) of each layer within the animation.