

60 Watts

- Ultra Compact Size
- Single Outputs from 3.3 to 48 V
- Encapsulated
- PCB & Chassis Mount Versions
- <0.3 W No Load Input Power
- -40 to +70 °C Operation
- Peak Load Capability
- 3 Year Warranty



The ECE60 series of compact encapsulated AC-DC power modules are available in both PCB & chassis mount versions offering exceptional power density of >10W/in³. Output voltages are available from 3.3 – 48 VDC and these “green power” modules offer high active mode efficiency and low no load power consumption. They also provide a peak load capability up to 130% of nominal power for up to 30s and a wide operating temperature range from -40 to +70°C.

Dimensions:

ECE60:

3.60 x 1.50 x 1.10" (91.4 x 38.1 x 28.0 mm)

ECE60-S:

4.45 x 1.57 x 1.12" (113.0 x 40.0 x 28.5 mm)

Models & Ratings

Output Power	Output Voltage	Output Current		Efficiency ⁽⁴⁾	Model Number ^(2,3)
		Nominal	Peak ⁽¹⁾		
33 W	3.3 V	10.00 A	13.00 A	79%	ECE60US03
50 W	5.0 V	10.00 A	13.00 A	83%	ECE60US05
60 W	9.0 V	6.67 A	8.67 A	87%	ECE60US09
60 W	12.0 V	5.00 A	6.50 A	87%	ECE60US12
60 W	15.0 V	4.00 A	5.20 A	88%	ECE60US15
60 W	24.0 V	2.50 A	3.25 A	89%	ECE60US24
60 W	36.0 V	1.67 A	2.17 A	88%	ECE60US36
60 W	48.0 V	1.25 A	1.63 A	86%	ECE60US48

Notes

1. Peak load lasting <30 s with a maximum duty cycle of 10%, average output power not to exceed nominal power.
2. Add suffix -S to model number to denote chassis mount with screw terminal type, e.g. ECE60US12-S.
3. A screw terminal version (-S) is available with DIN Clip attached. Add suffix 'D', e.g. ECE60US24-SD. DIN Rail mounting clip is available as a separate item, order code ECE60 DIN CLIP.
4. Average of efficiencies measured at 25%, 50%, 75% & 100% load with 230 VAC input.

Summary

Characteristic	Minimum	Typical	Maximum	Units	Notes & Conditions
Input Range	85		264	VAC	Derate load from 100% at 90 VAC to 90% at 85 VAC
	120		370	VDC	
No Load Input Power		<0.3		W	12-36 V versions
		<0.5		W	3.3-9 V & 48 V versions
Efficiency	79	87	89	%	See note 4 above
Operating Temperature	-40		+70	°C	Some specification parameters may not met below -25 °C. Derate linearly from 100% load at +50 °C to 50% load at 70 °C.
EMC	EN55032 Level B Conducted & Radiated, EN61000-4, EN61000-3				
Safety Approvals	IEC / EN / UL 62368-1, CSA per cUL				

Input

Characteristic	Minimum	Typical	Maximum	Units	Notes & Conditions
Input Voltage - Operating	85		264	VAC	Derate load from 100% at 90 VAC to 90% at 85 VAC
	120		370	VDC	
Input Frequency	47		63	Hz	
Power Factor					EN61000-3-2 class A compliant
Input Current		0.6		A rms	At 230 VAC
No Load Input Power			0.3	W	12-36 V versions
			0.5	W	3.3-9V & 48 V versions
Inrush Current		25/50		A	115/230 VAC cold start at 25 °C
Earth Leakage Current					Class II construction no earth
Input Protection	Internal T2.5 A/250 VAC fuse				

Output

Characteristic	Minimum	Typical	Maximum	Units	Notes & Conditions
Output Voltage	3.3		48	VDC	See Models and Ratings table
Initial Set Accuracy			±1	%	
Minimum Load	0			A	
Start Up Delay			2	s	
Start Up Rise Time			30	ms	
Hold Up Time	16			ms	At full load and 115 VAC
Line Regulation			±0.5	%	
Load Regulation			±2	%	ECE60US03/05-S
			±1	%	All other models
Transient Response			4	%	Recovery within 1% in less than 500 µs for a 25% load change
Ripple & Noise			60	mV pk-pk	3.3-5 V versions, 20 MHz bandwidth
			75	mV pk-pk	3.3-5 V '-S' versions, 20 MHz bandwidth, 0.1 µF capacitor at output terminals
			1	% pk-pk	20 MHz bandwidth all other models
Overvoltage Protection	195		216	% Vnom	ECE60US03 models
	115		140	% Vnom	All other models
Overload Protection	110		180	%	
Short Circuit Protection					Trip & restart (hiccup mode)
Temperature Coefficient			0.05	%/°C	

General

Characteristic	Minimum	Typical	Maximum	Units	Notes & Conditions
Efficiency	79	87	89	%	See Models & Ratings table
Isolation	3000			VAC	Input to Output
Switching Frequency		100		kHz	
Power Density			10.1	W/in ³	
Mean Time Between Failure		>300		kHrs	MIL-HDBK-217F, +25 °C GB
Weight		0.42 (191)		lb (g)	ECE60
		0.44 (200)			ECE60-S

Environmental

Characteristic	Minimum	Typical	Maximum	Units	Notes & Conditions
Operating Temperature	-40		+70	°C	Some specification parameters may not met below -25 °C. Derate linearly from 100% load at +50 °C to 50% load at 70 °C.
Storage Temperature	-40		+85	°C	
Cooling					Convection-cooled
Humidity			95	%RH	Non-condensing
Operating Altitude			3048	m	
Vibration	2 g, 10 Hz to 500 Hz, 10 mins/cycle, 60 mins each cycle				

EMC: Emissions

Phenomenon	Standard	Test Level	Criteria	Notes & Conditions
Conducted	EN55032	Class B		
Radiated	EN55032	Class B		
Harmonic Current	EN61000-3-2			Class A
Voltage Flicker	EN61000-3-3			

EMC: Immunity

Phenomenon	Standard	Test Level	Criteria	Notes & Conditions
ESD	EN61000-4-2	3	A	
Radiated	EN61000-4-3	10 V/m 80% mod	A	
EFT	EN61000-4-4	3	A	
Surges	EN61000-4-5	Installation Class 3	A	
Conducted	EN61000-4-6	3	A	
Dips and Interruptions	EN61000-4-11	DIP: 100% 10 ms DIP: 30% 500 ms INT: 100% 5000 ms	A A B	

Safety Approvals

Safety Agency	Safety Standard	Notes & Conditions
UL	UL 62368-1 & CAN/CSA C22.2 No. 62368-1-14,	
TUV	EN62368-1:2014/A11:2017	
CB	IEC60950-1:2005 Ed 2 / IEC62368-1:2014	
CE	Meets all applicable directives	
UKCA	Meets all applicable legislation	

Mechanical Details

ECE60

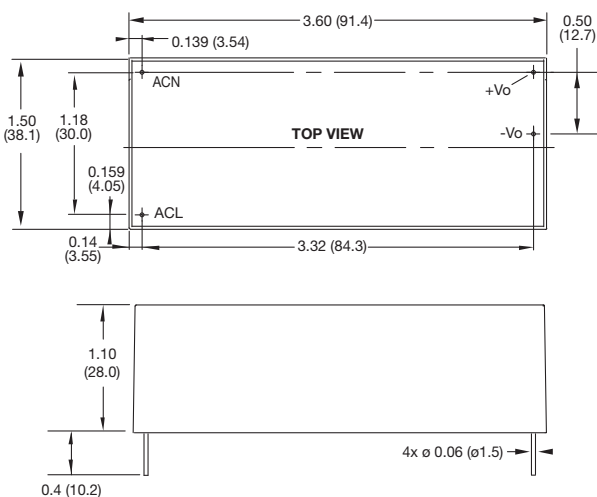

ECE60 Screw Terminal (-S)

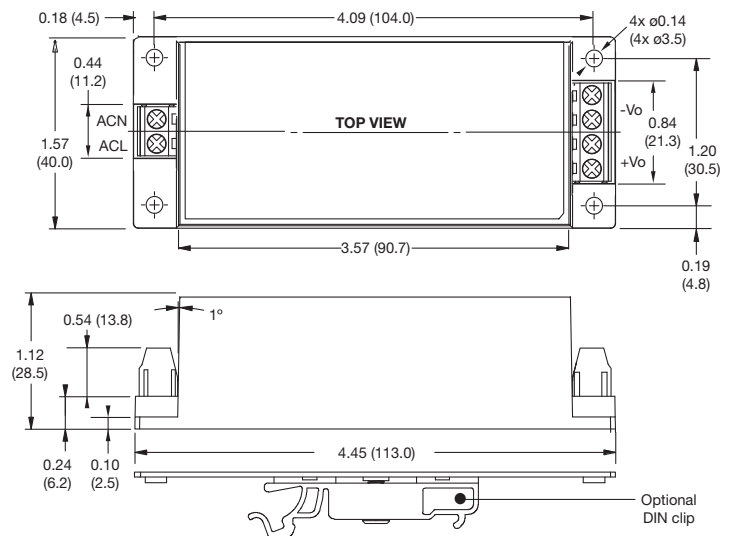

Notes

- All dimensions in inches (mm).
- Weight: ECE60: 0.42 lbs (191 g)
ECE60-S: 0.44 lbs (200 g)
- Tolerances: x.xx = \pm 0.02 (x.x = \pm 0.5), x.xxx = \pm 0.01 (x.xx = \pm 0.25)