



1600~8000W 1U Distributed Power/Charger System **RHP-1U Rack System**

Rack Dimension

| | | | | |
|------|---|------|---|---------------|
| L | * | W | * | H |
| 365 | * | 440 | * | 44 (1U) mm |
| 14.4 | * | 17.3 | * | 1.73(1U) inch |



■ Features

- Universal AC input / Full range
- 1U profile 19" rack shelf, fitting five 1600W modules up to 8000W with active current sharing
- Output voltage and current programmable
- Support hot swap (hot plug)
- Built-in PMBus protocol (Optional CANBus protocol)
- 5 years warranty

■ Applications

- Distributed power architecture system
- Wireless/telecommunication solution
- Electric vehicle or marine charger station
- DC UPS or emergency backup
- Wastewater treatment system
- Electrolysis system

■ Description

RHP-1U rack power system and RHB-1U rack charger system are the complete solution for the power distribution utilizing the rack configuration with the 1U low profile. Starting with a single unit of 1600W, RCP-1600 is the front end rectifier (or, power supply) and RCB-1600 is the charger module. With the active current sharing function, up to 8000W is able to be provided by 1 stack of the 19" rack mountable shelf RHP-1U, with either rectifier or charger, and 24000W by 3 stacks with rectifier.

■ Model Encoding

Rack Shelf:

RHP-1U I -A □

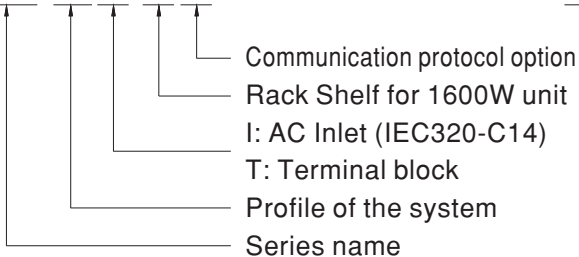

Whole System:

RHP-8K1U I -12 □

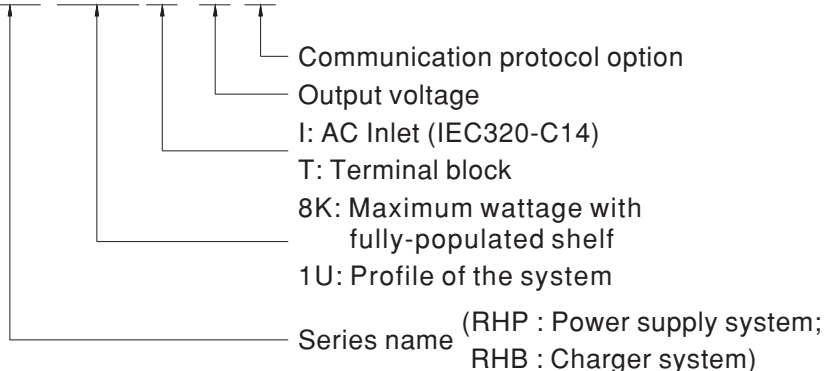

| Type | Communication Protocol | Note |
|-------|------------------------|------------|
| Blank | PMBus protocol | In Stock |
| CAN | CANBus protocol | By request |



1600~8000W 1U Distributed Power/Charger System **RHP-1U Rack System**

SPECIFICATION - Power Supply System

| MODEL | | RHP-8K1U□-12 | RHP-8K1U□-24 | RHP-8K1U□-48 | |
|--------------------------------------|---|---|-------------------------|---|--|
| OUTPUT | RECTIFIER | RCP-1600-12 | RCP-1600-24 | RCP-1600-48 | |
| | RACK SHELF | RHP-1UI-A or RHP-1UT-A | | | |
| | OUTPUT VOLTAGE | 12V | 24V | 48V | |
| | MAX. OUTPUT CURRENT | 625A | 335A | 167.5A | |
| | MAX. OUTPUT POWER <small>Note.5</small> | 7500W | 8040W | 8040W | |
| INPUT | VOLTAGE RANGE <small>Note.6</small> | 90 ~ 264VAC 127 ~ 370VDC | | | |
| | FREQUENCY RANGE | 47 ~ 63Hz | | | |
| | AC CURRENT (Typ.) per RECTIFIER | 14A/115VAC 8A/230VAC | 15A/115VAC 8.5A/230VAC | 15A/115VAC 8.5A/230VAC | |
| | LEAKAGE CURRENT per RECTIFIER <small>Note.8</small> | <1.5mA / 230VAC | | | |
| FUNCTION | OUTPUT VOLTAGE PROGRAMMABLE(PV) | Adjustment of output voltage is allowable to 40 ~ 125% of nominal output voltage(60~125% for 12V). Please refer to the Function Manual. | | | |
| | CONSTANT CURRENT LEVEL PROGRAMMABLE(PC) | Adjustment of constant current level is allowable to 20 ~ 100% of rated current. Please refer to the Function Manual. | | | |
| | REMOTE ON-OFF CONTROL | By electrical signal or dry contact ON:short OFF:open | | | |
| | REMOTE SENSE | Compensate voltage drop on the load wiring up to 0.5V | | | |
| | AUXILIARY POWER | 5V @ 0.3A, 12V @ 0.8A | | | |
| | ALARM SIGNAL | Isolated TTL signal output for T-Alarm, AC-OK and DC-OK | | | |
| ENVIRONMENT | WORKING TEMP. | -30 ~ +70°C (Refer to "Derating Curve") | | | |
| | WORKING HUMIDITY | 20 ~ 90% RH non-condensing | | | |
| | STORAGE TEMP., HUMIDITY | -40 ~ +85°C, 10 ~ 95% RH non-condensing | | | |
| | TEMP. COEFFICIENT | ±0.03%/°C (0 ~ 50°C) | | | |
| | VIBRATION | 10 ~ 500Hz, 2G 10min./1cycle, 60min. each along X, Y, Z axes | | | |
| SAFETY & EMC <small>(Note 4)</small> | SAFETY STANDARDS | UL62368-1, CAN/CSA C22.2 No. 62368-1, TUV BS EN/EN62368-1, EAC TP TC 004 approved | | | |
| | WITHSTAND VOLTAGE | I/P-O/P:3KVAC I/P-FG:2KVAC O/P-FG:1.5KVAC (0.5KVAC for 12V) | | | |
| | ISOLATION RESISTANCE | I/P-O/P, I/P-FG, O/P-FG:100M Ohms / 500VDC / 25°C / 70% RH | | | |
| | EMC EMISSION | Parameter | Standard | Test Level / Note | |
| | | Conducted | BS EN/EN55032 (CISPR32) | Class B | |
| | | Radiated | BS EN/EN55032 (CISPR32) | Class A | |
| | | Harmonic Current | BS EN/EN61000-3-2 | Class A | |
| | | Voltage Flicker | BS EN/EN61000-3-3 | ----- | |
| | EMC IMMUNITY | BS EN/EN55024, BS EN/EN61000-6-2 | | | |
| | | Parameter | Standard | Test Level / Note | |
| | | ESD | BS EN/EN61000-4-2 | Level 3, 8KV air ; Level 2, 4KV contact | |
| | | Radiated | BS EN/EN61000-4-3 | Level 3 | |
| | | EFT / Burst | BS EN/EN61000-4-4 | Level 3 | |
| | | Surge | BS EN/EN61000-4-5 | Level 4, 2KV/Line-Line 4KV/Line-Earth | |
| Conducted | | BS EN/EN61000-4-6 | Level 3 | | |
| Magnetic Field | | BS EN/EN61000-4-8 | Level 4 | | |
| Voltage Dips and Interruptions | BS EN/EN61000-4-11 | >95% dip 0.5 periods, 30% dip 25 periods, >95% interruptions 250 periods | | | |
| OTHERS | DIMENSION | Rack 365*482.6*44(L*W*H, with mounting bracket) ; 365*440*44(L*W*H, without mounting bracket) | | | |
| | PACKING | 5.5Kg; 3pcs/17.5Kg/2.11CUFT | | | |
| NOTE | <ol style="list-style-type: none"> All parameters NOT specially mentioned are measured at 230VAC input, rated load and 25°C of ambient temperature. Ripple & noise are measured at 20MHz of bandwidth by using a 12" twisted pair-wire terminated with a 0.1uf & 47uf parallel capacitor. Under parallel operation of more than one rack connecting together, ripple of the output voltage may be higher than the SPEC at light load condition. It will go back to normal ripple level once the output load is more than 5%. Tolerance : includes set up tolerance, line regulation and load regulation. The power supply is considered a component which will be installed into a final equipment. All the EMC tests are been executed by mounting the unit on a 1000mm*1300mm metal plate with 1mm of thickness. The final equipment must be re-confirmed that it still meets EMC directives. For guidance on how to perform these EMC tests, please refer to "EMI testing of component power supplies." (as available on http://www.meanwell.com) Output of all the RCP-1600 modules are connected in parallel in the rack. Derating may be needed under low input voltages. Please check the static characteristics for more details. Because of component tolerance, there is a possibility that some of units connected in parallel will reach an overcurrent limit then overloading the other units when operating at full load condition. If overload conditions happen in parallel usage, it is suggested that derate the total output current by 10%. The equivalent leakage current of the system is determined by the quantity of populated rectifiers. The ambient temperature derating of 3.5°C/1000m with fanless models and of 5°C/1000m with fan models for operating altitude higher than 2000m(6500ft). <p>※ Product Liability Disclaimer : For detailed information, please refer to https://www.meanwell.com/serviceDisclaimer.aspx</p> | | | | |



1600~8000W 1U Distributed Power/Charger System **RHP-1U Rack System**

SPECIFICATION - Charger System

| MODEL | | RHB-8K1U□-12 | RHB-8K1U□-24 | RHB-8K1U□-48 |
|--------------------------------------|--|--|------------------------|------------------------|
| OUTPUT | CHARGER | RCB-1600-12 | RCB-1600-24 | RCB-1600-48 |
| | RACK SHELF | RHP-1UI-A or RHP-1UT-A | | |
| | BOOST CHARGE VOLTAGE(Vboost)(default) | 14.4V | 28.8V | 57.6V |
| | FLOAT CHARGE VOLTAGE(Vfloat)(default) | 13.8V | 27.6V | 55.2V |
| | CURRENT RANGE | 0 ~ 500A | 0 ~ 275A | 0 ~ 137.5A |
| INPUT | VOLTAGE RANGE <small>Note.2</small> | 90 ~ 264VAC 127 ~ 370VDC | | |
| | FREQUENCY RANGE | 47 ~ 63Hz | | |
| | AC CURRENT (Typ.) per CHARGER | 14A/115VAC 8A/230VAC | 15A/115VAC 8.5A/230VAC | 15A/115VAC 8.5A/230VAC |
| | LEAKAGE CURRENT per CHARGER <small>Note.5</small> | <1.5mA / 230VAC | | |
| FUNCTION | OUTPUT VOLTAGE PROGRAMMABLE(PV) | Adjustment of output voltage is allowable to 75 ~ 125% of nominal output voltage. Please refer to the Function Manual. | | |
| | OUTPUT CURRENT PROGRAMMABLE(PC) | Adjustment of output current is allowable to 20 ~ 100% of rated current. Please refer to the Function Manual. | | |
| | REMOTE ON-OFF CONTROL | By electrical signal or dry contact ON:short OFF:open | | |
| | AUXILIARY POWER | 5V @ 0.3A, 12V @ 0.8A | | |
| | ALARM SIGNAL | The isolated TTL signal out, Please refer to Installation Manual | | |
| | TEMPERATURE COMPENSATION | -3mV / °C / cell / (12V = 6 cells ; 24V = 12 cells ; 48V = 24 cells) | | |
| ENVIRONMENT | WORKING TEMP. | -30 ~ +70°C (Refer to "Derating Curve") | | |
| | WORKING HUMIDITY | 20 ~ 90% RH non-condensing | | |
| | STORAGE TEMP., HUMIDITY | -40 ~ +85°C, 10 ~ 95% RH non-condensing | | |
| | TEMP. COEFFICIENT | ±0.03%/°C (0 ~ 50°C) | | |
| | VIBRATION | 10 ~ 500Hz, 2G 10min./1cycle, 60min. each along X, Y, Z axes | | |
| SAFETY & EMC <small>(Note 4)</small> | SAFETY STANDARDS | UL62368-1, TUV BS EN/EN62368-1, EAC TP TC 004 approved | | |
| | WITHSTAND VOLTAGE | I/P-O/P:3KVAC I/P-FG:2KVAC O/P-FG:1.5KVAC (0.5KVAC for 12V) | | |
| | ISOLATION RESISTANCE | I/P-O/P, I/P-FG, O/P-FG:100M Ohms / 500VDC / 25°C / 70% RH | | |
| | EMC EMISSION | Compliance to BS EN/EN55032 (CISPR32) Conduction Class B, Radiation Class A ; BS EN/EN61000-3-2,-3, EAC TP TC 020 | | |
| | EMC IMMUNITY | Compliance to BS EN/EN61000-4-2,3,4,5,6,8,11, BS EN/EN61000-6-2 (BS EN/EN50082-2), Heavy industry level, criteria A, EAC TP TC 020 | | |
| OTHERS | DIMENSION | Rack 365*482.6*44(L*W*H, with mounting bracket) ; 365*440*44(L*W*H, without mounting bracket) | | |
| | PACKING | 5.5Kg; 3pcs/17.5Kg/2.11CUFT | | |
| NOTE | <p>1. All parameters NOT specially mentioned are measured at 230VAC input, rated load and 25°C of ambient temperature.</p> <p>2. Derating may be needed under low input voltages. Please check the static characteristics for more details.</p> <p>3. The power supply is considered a component which will be installed into a final equipment. All the EMC tests are been executed by mounting the unit on a 1000mm*1300mm metal plate with 1mm of thickness. The final equipment must be re-confirmed that it still meets EMC directives. For guidance on how to perform these EMC tests, please refer to "EMI testing of component power supplies." (as available on http://www.meanwell.com)</p> <p>4. Output of all the RCB-1600 modules are connected in parallel in the rack.</p> <p>5. The equivalent leakage current of the system is determined by the quantity of populated chargers.</p> <p>6. The ambient temperature derating of 3.5°C/1000m with fanless models and of 5°C/1000m with fan models for operating altitude higher than 2000m(6500ft).</p> <p>※ Product Liability Disclaimer : For detailed information, please refer to https://www.meanwell.com/serviceDisclaimer.aspx</p> | | | |

Function Manual

1. Voltage Drop Compensation (Only for power supply system)

1.1 Remote Sense

The remote sense compensates voltage drop on the load wiring up to 0.5V.

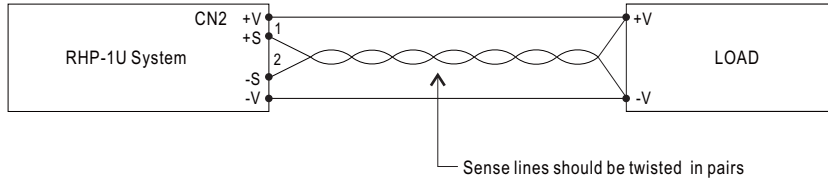

1.2 Local Sense

Notice : The +S,-S have to be connected to the +V(signal),-V(signal),respectively, in order to get the correct output voltage if the remote sensing is not used.

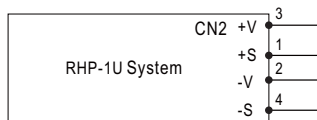

2. Output Voltage Programming (or, PV / remote voltage programming / remote adjust / margin programming / dynamic voltage trim)

※ In addition to the adjustment via the built-in potentiometer, the output voltage can be trimmed by applying EXTERNAL VOLTAGE.

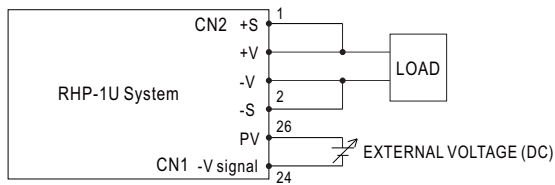

+S & +V, -S & -V also need to be connected on CN1. (Only for power supply system)

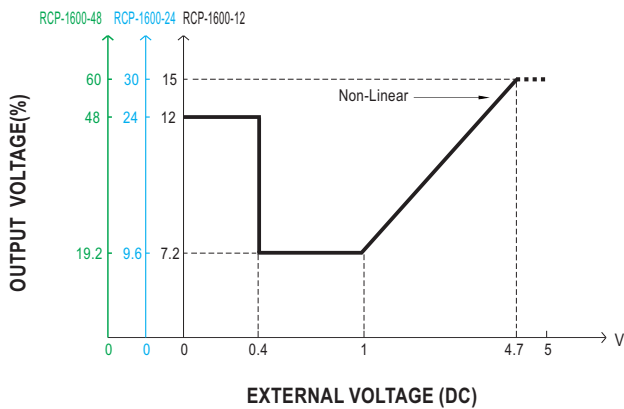
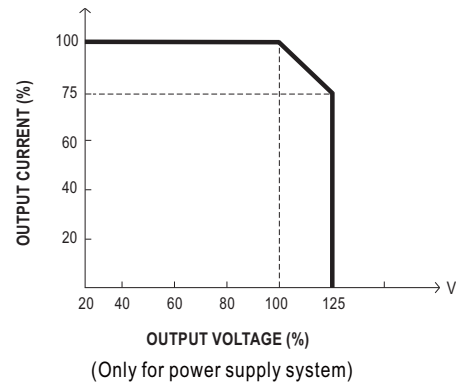

◎ For power supply system

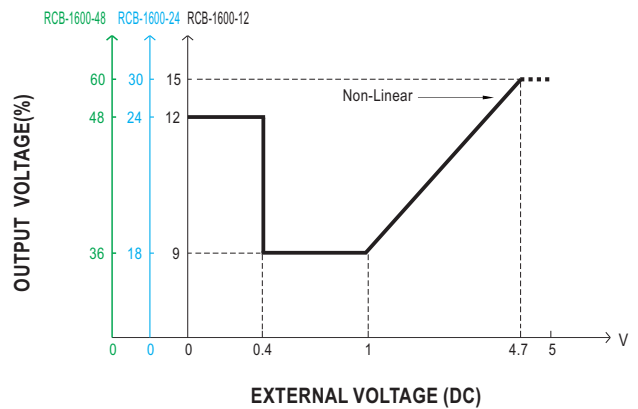

◎ For charger system

3. Output Current Programming (or, PC / remote current programming / dynamic current trim)

※ The output current can be trimmed to 20~100% of the rated current by applying EXTERNAL VOLTAGE.

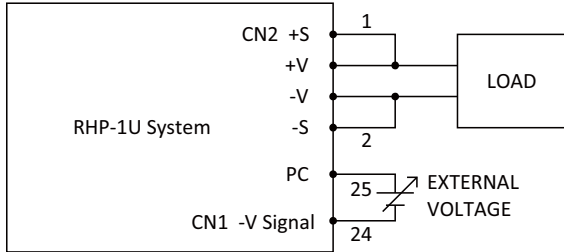

+S & +V, -S & -V also need to be connected on CN1. (Only for power supply system)

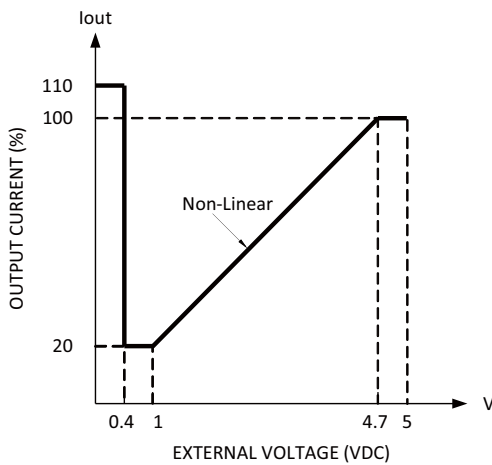

⊙ For power supply system

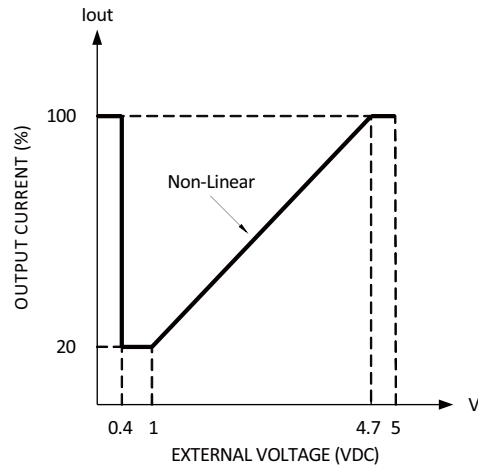

⊙ For charger system

4. Remote ON-OFF Control

The PSU can be turned ON/OFF together or separately by using the "Remote ON/OFF" function.

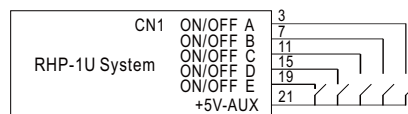
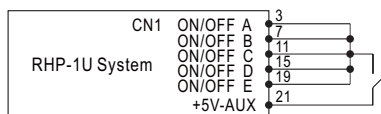

| Between ON/OFF and +5V-AUX | Output |
|----------------------------|--------|
| SW Open | OFF |
| SW Short | ON |

5. PMBus Communication Interface

RCP-1600/RCB-1600 supports PMBus Rev. 1.1 with maximum 100KHz bus speed, allowing information reading, status monitoring, output trimming, etc. For details, please refer to the Function Manual.

Mechanical Specification

Case No.242A Unit:mm

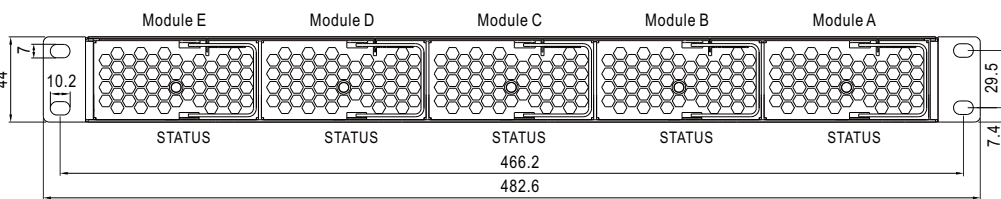
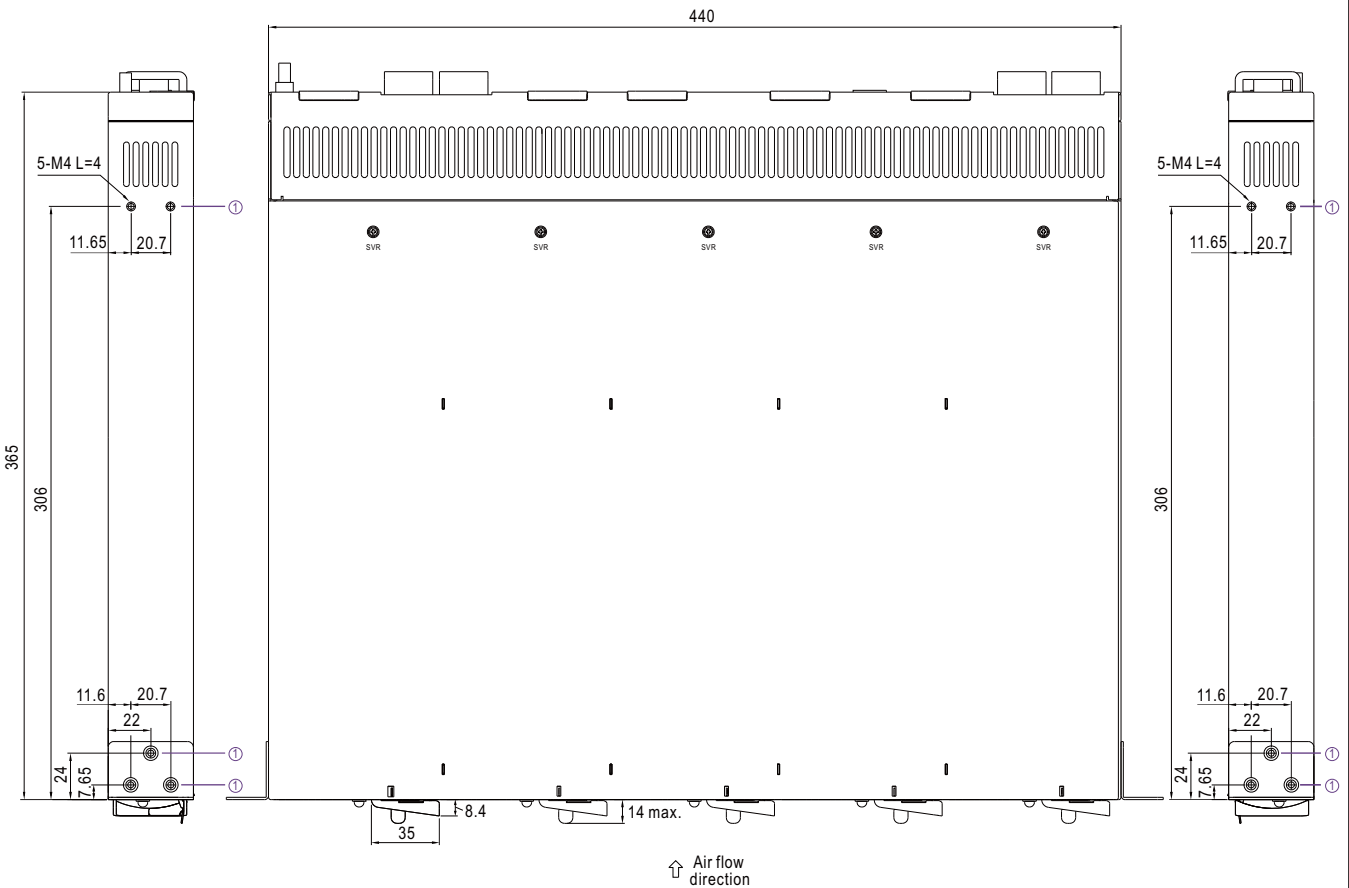
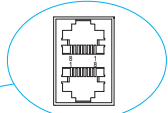
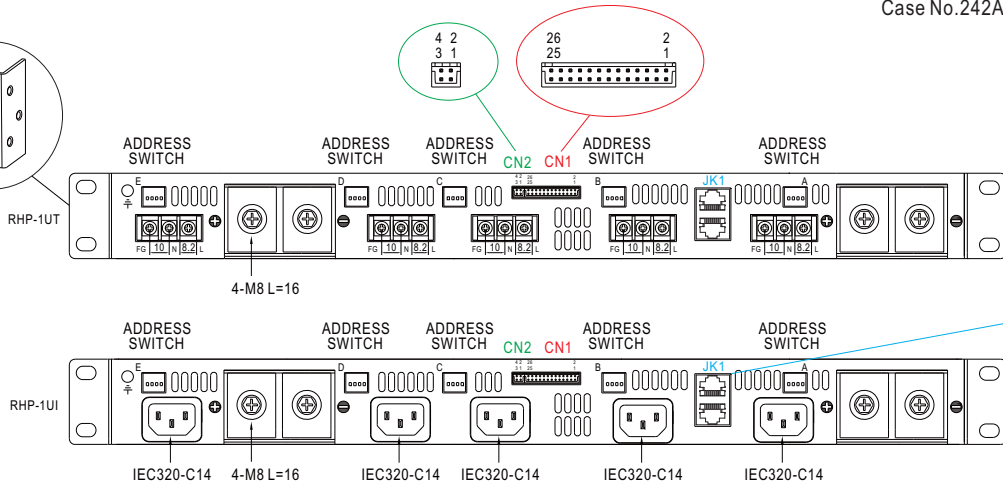
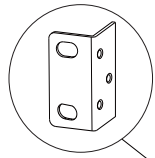

※ Mounting Instruction

| Hole No. | Recommended Screw Size | MAX. Penetration Depth L | Recommended mounting torque |
|----------|------------------------|--------------------------|-----------------------------|
| ① | M4 | 4mm | 7~10Kgf-cm |

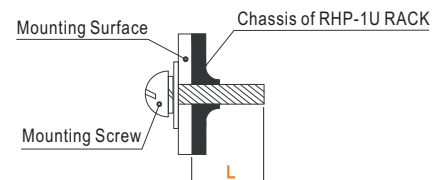

※ LED Status Indicators & Corresponding Signal at Function Pins

◎ For power supply system

| LED | Description |
|-----|---|
| | The power supply functions normally. |
| | The LED will present a constant red light when the abnormal status (OTP, OLP, fan fail and charging timeout) arises. |
| | The LED will flash with the red light when the internal temperature reaches 60°C; under this condition, the unit still operates normally without entering OTP. (In the meantime, an alarm signal will be sent out through the PMBus interface.) |

◎ For charger system

| LED | Description |
|-----|---|
| | Float (stage 3) |
| | Charging (stage 1 or stage 2) |
| | The LED will present a constant red light when the abnormal status (OTP, OLP, fan fail and charging timeout) arises. |
| | The LED will flash with the red light when the internal temperature reaches 60°C; under this condition, the unit still operates normally without entering OTP. (In the meantime, an alarm signal will be sent out through the PMBus interface.) |

※ Connector Pin No. Assignment(CN1) : HRS DF11-26DP-2DS

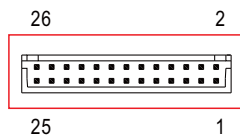

| | |
|----------------|-----------------------------|
| Mating Housing | HRS DF11-26DS or equivalent |
| Terminal | HRS DF11-26SC or equivalent |

| Pin No. | Function | Description |
|--------------|---------------|--|
| 1,5,9,13,17 | AC-OK | High (4.5 ~ 5.5V) : When the input voltage is $\geq 87V_{rms}$. Low (-0.1 ~ 0.5V) : When the input voltage is $\leq 75V_{rms}$. The maximum sourcing current is 10mA and only for output. (Note.2) |
| 2,6,10,14,18 | DC-OK | For power supply system High (4.5 ~ 5.5V) : When the $V_{out} \leq 80\% \pm 5\%$. Low (-0.1 ~ 0.5V) : When $V_{out} \geq 80\% \pm 5\%$. The maximum sourcing current is 10mA and only for output. (Note.2) For charger system High (4.5 ~ 5.5V) : When the $V_{out} \leq 8V/16V/32V \pm 1V$. Low (-0.1 ~ 0.5V) : When $V_{out} \geq 8V/16V/32V \pm 1V$. The maximum sourcing current is 10mA and only for output. (Note.2) DC OK is associated with battery low protection. |
| 3,7,11,15,19 | Remote ON-OFF | The unit can turn the output ON/OFF by electrical signal or dry contact between Remote ON-OFF and +5V-AUX. (Note.2) Short (4.5 ~ 5.5V) : Power ON ; Open (0 ~ 0.5V) : Power OFF ; The maximum input voltage is 5.5V. |
| 4,8,12,16,20 | T-ALARM | High (4.5 ~ 5.5V) : When the internal temperature exceeds the limit of temperature alarm, or when fan fails. Low (-0.1 ~ 0.5V) : When the internal temperature is normal, and when fan normally works. The maximum sourcing current is 10mA and only for output(Note.2) |
| 21 | +5V-AUX | Auxiliary voltage output, 4.5~5.5V, referenced to GND-AUX (pin 22). The maximum load current is 0.3A. This output has the built-in "Oring diodes" and is not controlled by the remote ON/OFF control. |
| 22 | GND-AUX | Auxiliary voltage output GND. The signal return is isolated from the output terminals (+V & -V). |
| 23 | +12V-AUX | Auxiliary voltage output, 10.8~13.2V, referenced to GND-AUX (pin 22). The maximum load current is 0.8A. This output has the built-in "Oring diodes" and is not controlled by the remote ON/OFF control. |
| 24 | -V(Signal) | Negative output voltage. For local sense use only; It can't be connected directly to the load. |
| 25 | PC | Connection for output current programming. The current can be trimmed within its defined range. (Note.1) |
| 26 | PV | Connection for output voltage programming. The voltage can be trimmed within its defined range. (Note.1) |

Note.1: Non-isolated signal, referenced to [-V(signal)].

Note.2: Isolated signal, referenced to GND-AUX.

※ Connector Pin No. Assignment(CN2) : HRS DF11-4DP-2DS

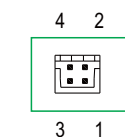

| | |
|----------------|----------------------------|
| Mating Housing | HRS DF11-4DS or equivalent |
| Terminal | HRS DF11-4SC or equivalent |

◎ For power supply system

| | | |
|---|------------|---|
| 1 | +S | Positive sensing. The +S signal should be connected to the positive terminal of the load. The +S and -S leads should be twisted in pair to minimize noise pick-up effect. The maximum line drop compensation is 0.5V. |
| 2 | -S | Negative sensing. The -S signal should be connected to the negative terminal of the load. The -S and +S leads should be twisted in pair to minimize noise pick-up effect. The maximum line drop compensation is 0.5V. |
| 3 | +V(Signal) | Positive output voltage. For local sense use only, can't be connected directly to the load. |
| 4 | -V(Signal) | Negative output voltage. For local sense use only, can't be connected directly to the load. |

◎ For charger system

| | | |
|-----|------|--|
| 1 | RTH+ | Temperature sense associated with the temperature compensation function. |
| 2 | RTH- | |
| 3,4 | NC | Not use. |

※ Connector Pin No. Assignment(JK1) : RJ45 8 positions

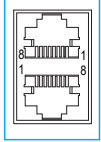

| Pin No. | Function | Description |
|---------|------------|---|
| 1,2 | DA,DB | Differential digital signal for parallel control. (Note.1) |
| 3 | -V(signal) | Negative output voltage signal. It is for local sense and certain function reference; it cannot be connected directly to the load. |
| 4 | CONTROL | Remote ON-OFF control pin used in the PMBus interface. (Note.2) |
| 5 | NC | Retain for future use. |
| 6 | SDA | For PMBus model: Serial Data used in the PMBus interface. (Note.2) |
| | CANH | For CANBus model: Data line used in CANBus interface. (Note.2) |
| 7 | SCL | For PMBus model: Serial Clock used in the PMBus interface. (Note.2) |
| | CANL | For CANBus model: Data line used in CANBus interface. (Note.2) |
| 8 | GND-AUX | Auxiliary voltage output GND. The signal return is isolated from the output terminals (+V & -V). |

Note.1: Non-isolated signal, referenced to [-V(signal)].

Note.2: Isolated signal, referenced to GND-AUX.