



# Elektrotechnik Karl-Heinz Mauz GmbH

---

**VM-2702A2.7-SMD** (Artikel-Nr. 860271)

**EKULIT**

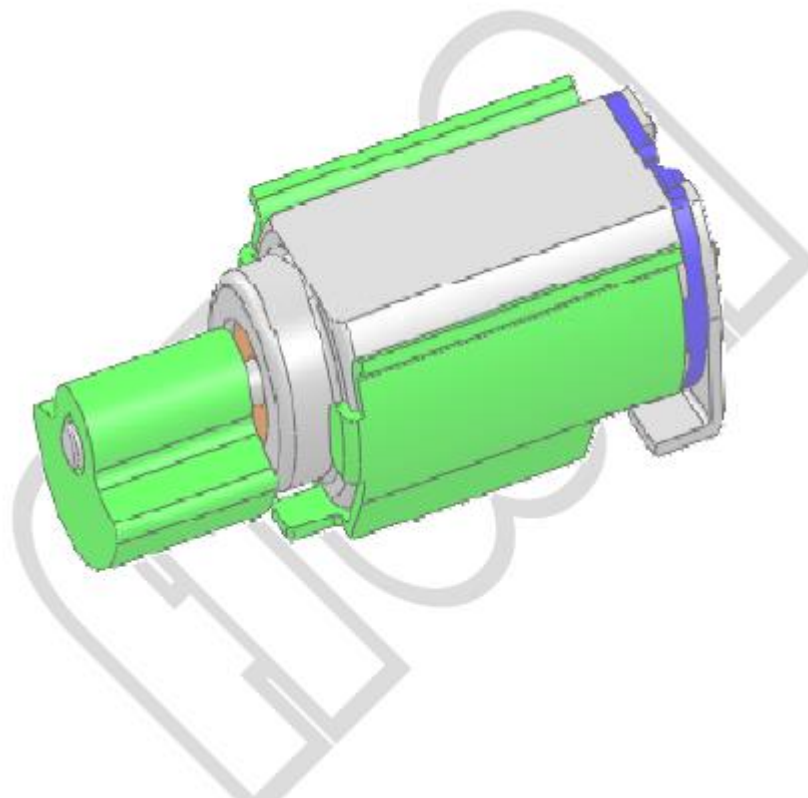



# Elektrotechnik Karl-Heinz Mauz GmbH

---

**VM-2702A2.7-SMD** (Artikel-Nr. 860271)

**EKULIT**

## Prolegomenon

1. Specification Revealal :

Please return this specification within one month since its publication otherwise it will be treated as signed and received articles additionally, if any regarding this spec. need to be adjusted or added for your esteemed company, please kindly contact our business executor.

2. Specification revises :

The revises of this spec. and its execution will be in our discussion and negotiation.  
If our spec. is revised, this spec. will be invalid as soon as you receive the revised one.

3. Special Notes:

- (1) Please check its performance advance while you start.
- (2) Specially declare, some parts of components can be changed in order to modify or improve its capacity.

### Revised Record

Rev.	Date	Designed	Revised	Page
V1.0	2010.04.20	Tony.L	Preliminary spec. Written	
V1.1	2012.11.13	Tony.L	Change the noise specification	3



# Elektrotechnik Karl-Heinz Mauz GmbH

**VM-2702A2.7-SMD** (Artikel-Nr. 860271)

**EKULIT**

## 1. Applications

This specification can apply to model GS-2702 DC core vibration motor, provided by AWA, to be used for cellular phone and other handy communication tools.

## 2. Standard Operating conditions

No	Item	Specifications
2-1	Rated voltage	2.7V
2-2	Operating voltage range	2.3-3.2V
2-3	Motor position	All position
2-4	Rated Load	Counterweight (R1.7*L2.8)
2-5	Rotation	CW
2-6	Operating environment	-20℃ ~ +70℃ (0 ~ 95%RH)
2-7	Storage environment	-40℃ ~ +85℃ (0 ~ 95%RH)

## 3. Measuring conditions

No	Item	Specifications
3-1	Normal temperature	20℃±2℃
3-2	Normal humidity	65±5%
3-3	Temperature for reference	5℃ ~ 35℃
3-4	Humidity for reference	30% ~ 90%
3-5	Motor position when testing	Motor shaft horizontal

## 4. Mechanical characteristics

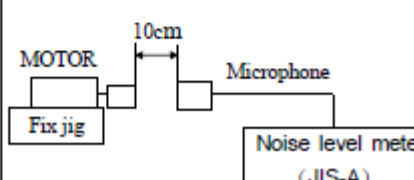
No	Item	Specifications	Conditions & Remarks
4-1	Appearance	Visual	No scar, rust, stain and dent
4-2	Weight	0.6g	
4-3	Pull-out strength of cw	3 Kg Min	
4-4	Axial play of shaft	0.3 mm MAX	
4-5	Vibration force (reference)	0.3G with 100g Jig	Under rated voltage and load
4-6	Rise time characteristics	0.2S MAX	Counterweight rotates by impression of standard voltage
4-7	Mechanical noise	45dB MAX (Background noise: 25dB MAX)	Measure at rated voltage and rated load (counterweight), according to shaft direction the distance between microphone and motor is 10cm. 

Adresse: Felix-Wankel-Str. 35 • 73760 Ostfildern/Nellingen

Tel: +49-711/3414023

Fax: +49-711/3414024

E-mail: [info@ekulit.de](mailto:info@ekulit.de)

Web site: [www.EKULIT.de](http://www.EKULIT.de)



# Elektrotechnik Karl-Heinz Mauz GmbH

VM-2702A2.7-SMD (Artikel-Nr. 860271)

**EKULIT**

## 5. Electrical characteristics

No	Item	Specifications
5-1	Rated voltage	2.7V
5-2	Rated current	65±10mA
5-3	Rated speed	14000±2500rpm
5-4	Starting current	90mA max
5-5	Starting voltage	2.3V max
5-6	Terminal resistance	33±6 Ω
5-7	Electrical Noise	Using ring Varistor
5-8	Insulation resistance	1MΩ Min Under 50V DC

## 6. Reliability test

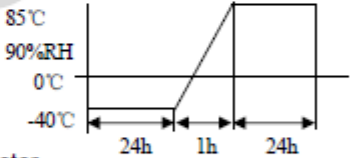
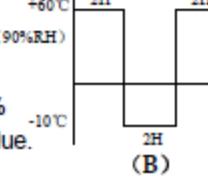
No	Item	Specifications
6-1	High temperature storage test	<ul style="list-style-type: none"> <li>Sample quantity: 4 pcs</li> <li>Temperature: 80°C</li> <li>Duration: 96hrs</li> <li>Criterion: RPM and other parameters must be within spec defined.</li> <li>The measurement is conducted after 4hours of recovery after test.</li> </ul>
6-2	Low temperature storage test	<ul style="list-style-type: none"> <li>Sample quantity: 4 pcs</li> <li>Temperature: -40°C</li> <li>Duration: 96hrs</li> <li>Criterion: RPM and other parameters must be within spec defined.</li> <li>The measurement is conducted after 4hours of recovery after test.</li> </ul>
6-3	Storage test	<ul style="list-style-type: none"> <li>Sample quantity: 4pcs</li> <li>Test conditions: Just as right sketch map</li> </ul>  <ul style="list-style-type: none"> <li>Without presence of water droplets on the motor.</li> <li>Criterion: RPM and other parameters must be within spec defined.</li> <li>The measurement is conducted after 24hours of recovery after test.</li> </ul>
6-4	Drop test	<ul style="list-style-type: none"> <li>Sample quantity: 4 pcs</li> <li>Test conditions: Height: 150cm, with a 100g Jig</li> <li>Floor: steel</li> <li>Drop cycles: ±X, ±Y, ±Z, every face 1 times</li> <li>Criterion: RPM and other parameters must be within spec defined.</li> </ul>
6-5	Lift test	<ul style="list-style-type: none"> <li>Sample quantity: 10pcs each type</li> <li>Test condition: 8s on/ 52s off every cycle</li> <li>Test environmental: (A)Temperature 60°C/Humidity 20%RH, (B)Just as below</li> <li>Duration: Condition (A) for 48 hours, (B) for 140 hours</li> </ul>  <ul style="list-style-type: none"> <li>Criterion: The deviation of RPM must be within +30%/-20% and rotate current within +20%/-30% of their initial value.</li> <li>Other parameters must be within spec defined.</li> <li>The measurement is conducted after 24hours of recovery after test.</li> </ul>

Adresse: Felix-Wankel-Str. 35 • 73760 Ostfildern/Nellingen

Tel: +49-711/3414023

Fax: +49-711/3414024

E-mail: [info@ekulit.de](mailto:info@ekulit.de) Web site: [www.EKULIT.de](http://www.EKULIT.de)

## VM-2702A2.7-SMD (Artikel-Nr. 860271)

# EKULIT

### 7. Lot manage

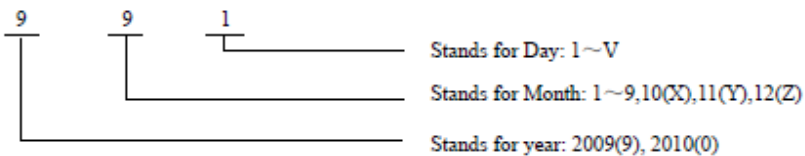

day	1	2	3	4	5	6	7	8	9	10	11	12	13	14	15	16
print	1	2	3	4	5	6	7	8	9	A	B	C	D	E	F	G
day	17	18	19	20	21	22	23	24	25	26	27	28	29	30	31	
print	H	I	J	K	L	M	N	O	P	Q	R	S	T	U	V	

### 8. Packing

#### 8-1 Smallest packing

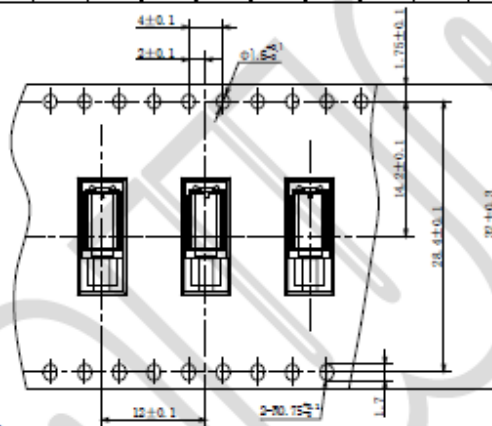

#### 8-2 Reel packing condition

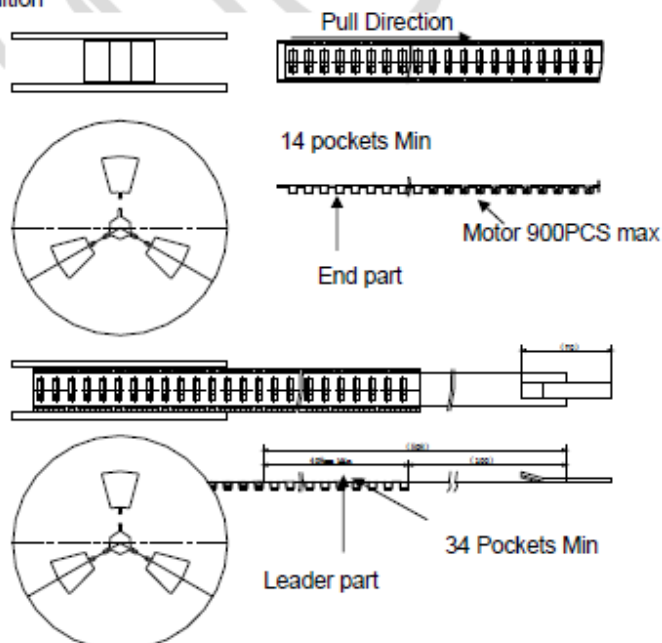

**VM-2702A2.7-SMD** (Artikel-Nr. 860271)

**EKULIT**

## 8-3 Final Packing Condition

The most: 900pcs/1 reel × 6 reel = 5400pcs



## Cautions

9-1 Whatever item not stated in this specification will not be guaranteed.

9-2 Do not subject the motor under locked condition for a long time.

9-3 Out-going test data will be attached (n = 35) for :

- Loaded rotation
- Loaded current
- Lock current
- Starting voltage
- Wiring resistance

9-4 The product can compliant with AWA requirement of HS management completely.

9-5 The inspection after reflow is implemented in production process.

9-6 Recommending reflow profile for Pb-free soldering.

## Reflow specification

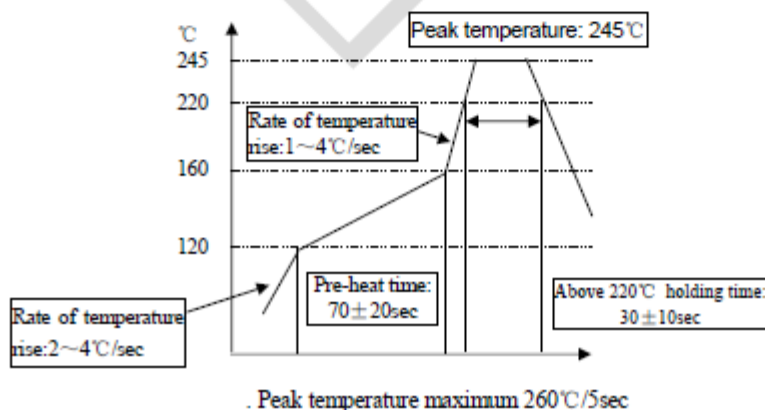

## VM-2702A2.7-SMD (Artikel-Nr. 860271)

# EKULIT

### 10. Outline drawing

