

SPECIFICATION

CUSTOMER : _____

MODULE NO.: **EA TFT050-84BTS**

<p>APPROVED BY: (FOR CUSTOMER USE ONLY)</p>	<p>PCB VERSION: _____</p> <p>DATA: _____</p>
--	--

SALES BY	APPROVED BY	CHECKED BY	PREPARED BY
			葉虹蘭
ISSUED DATE: 2021/04/15			

Content

1. Summary
2. General Specification
3. Absolute Maximum Ratings
4. Electrical Characteristics
5. Optical Characteristics
6. Interface
7. Reliability
8. Touch Panel Information
9. Contour Drawing

Preliminary

1. Summary

EA TFT050-84BTS is a TN transmissive type color active matrix TFT liquid crystal display that use amorphous silicon TFT as switching devices. This module is a composed of a TFT_LCD module, It is usually designed for industrial application and this module follows RoHS. Touchpanel controller ILI2130 is included.

1.1. Accessories

ZIF connector for display, bottom contact
ZIF connector for display, top contact
ZIF connector for touch panel, top contact

EA WF050-40S
EA WF050-40ST
EA WF050-10T

2. General Specifications

Item	Dimension	Unit
Size	5.0	inch
Dot Matrix	800× 3(RGB) × 480	dots
Module dimension	120.7(W) ×75.8(H) ×4.475mm	mm
Active area	108(W) ×64.8 (H) mm	mm
Dot pitch	0.135(W) ×0.135(H) mm	mm
LCD type	TFT, Normally White, Transmissive	
View Direction	12 o'clock	
Gray Scale Inversion Direction	6 o'clock	
Aspect Ratio	16:9	
Backlight Type	LED, Normally White	
CTP IC	ILI2130 or Equivalent	
CTP Interface	I2C	
CTP FW Version	0x07.0x00.0x00.0x00.0xA1.0x25.0x50.0x00	
CTP Resolution	16384*16384	
Surface	Glare	

*Color tone slight changed by temperature and driving voltage.

3. Absolute Maximum Ratings

Item	Symbol	Min	Typ	Max	Unit
Operating Temperature	TOP	-20	—	+70	°C
Storage Temperature	TST	-30	—	+80	°C

Note: Device is subject to be damaged permanently if stresses beyond those absolute maximum ratings listed above

1. Temp. $\leq 60^{\circ}\text{C}$, 90% RH MAX. Temp. $> 60^{\circ}\text{C}$, Absolute humidity shall be less than 90% RH at 60°C

4. Electrical Characteristics

4.1. Typical Operation Conditions

Item	Symbol	Values			Unit	Remark
		Min.	Typ.	Max.		
Power voltage	VDD	3.0	3.3	3.6	V	
Current for Driver(Black)	IDD	-	110	170	mA	VDD=3.3V
Input logic high voltage	VIH	0.7 VDD	-	VDD	V	Note 1
Input logic low voltage	VIL	0	-	0.3 VDD		
Supply CTP	VDDT	3.0	3.3	3.6	V	
	ICTP	—	51	77	mA	

Note1: CLK,DE,R0~R7, G0~7, B0~7.

4.2. Backlight Driving Conditions

Item	Symbol	Values			Unit	Remark
		Min.	Typ.	Max.		
Voltage for LED backlight	VL	27	30	34	V	Note 1
Current for LED backlight	IL	--	40	--	mA	
LED life time	-	--	50,000	-	Hr	Note 2

Note 1: The LED Supply Voltage is defined by the number of LED at Ta=25°C and IL =20ma/pcs.

Note 2: The "LED life time" is defined as the module brightness decrease to 50% Original brightness at Ta=25°C and IL =20mA/pcs. The LED lifetime could be decreased if operating IL is lager than 25mA/pcs.

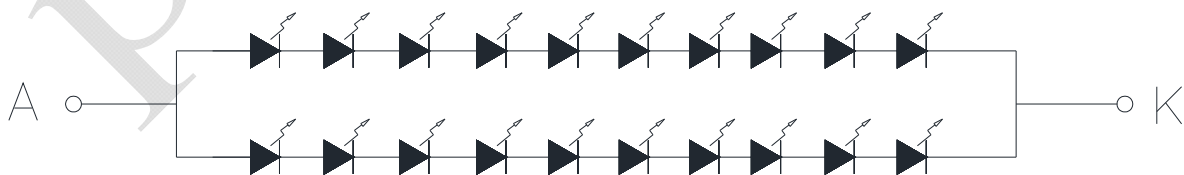

CIRCUIT DIAGRAM

4.3. Power Sequence

To prevent a latch-up or DC operation of the LCD module, the power on/off sequence should be as the diagram below.

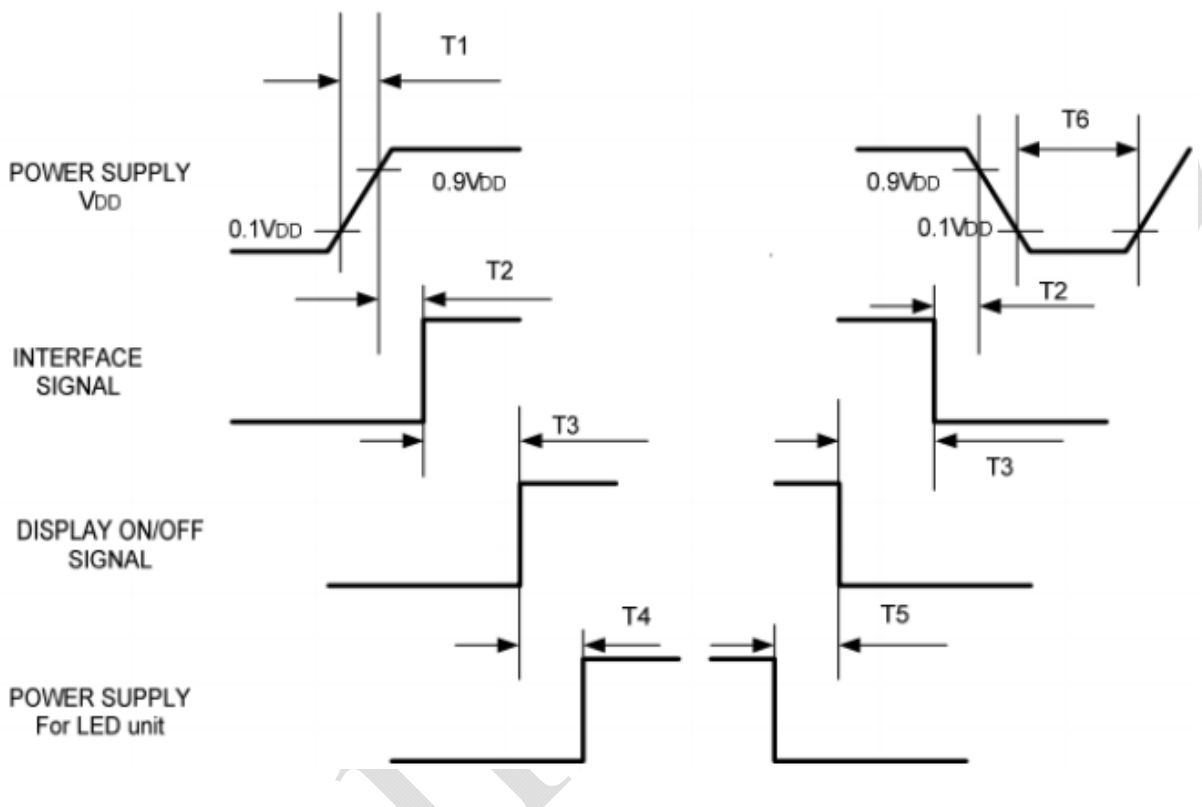

Symbol	Specification	Symbol	Specification
T1	$0 \leq T1 \leq 10 \text{ msec}$	T4	$200 \text{ msec} \leq T4$
T2	$16 \leq T2 \leq 100 \text{ msec}$	T5	$100 \text{ msec} \leq T5$
T3	$0 \leq T3 \leq 200 \text{ msec}$	T6	$16 \text{ msec} \leq T6$

4.4. Timing Characteristics

Timing conditions

Parallel DE mode RGB input timing table

Parameter	Symbol	Values			Unit	Remark
		Min.	Typ.	Max.		
CLK frequency	Fclk	26.4	33.3	46.8	MHz	
DEV period time	Tv	510	525	650	H	
DEV display area	Tvd	480			H	
DEV blanking	Tvd	30	45	170	H	
DEH period time	Th	862	1056	1200	CLK	
DEH display area	Thd	800			CLK	
DEH blanking	THb	62	256	400	CLK	
CLK cycle time	Tclk	21.3	30	37.8	ns	
Clock width of high level	Tcwh	40	50	60	%	
Clock width of low level	Tcwl	40	50	60	%	
Clock rising time	Trck	8	-	-	ns	
Clock falling time	Tfck	8	-	-	ns	
Data Setup Time	Tdasu	8	-	-	ns	
Data Hold Time	Tdahd	8	-	-	ns	
DE Setup Time	Tdesu	8	-	-	ns	
DE Hold Time	Tdehd	8	-	-	ns	

4.5. Timing diagram

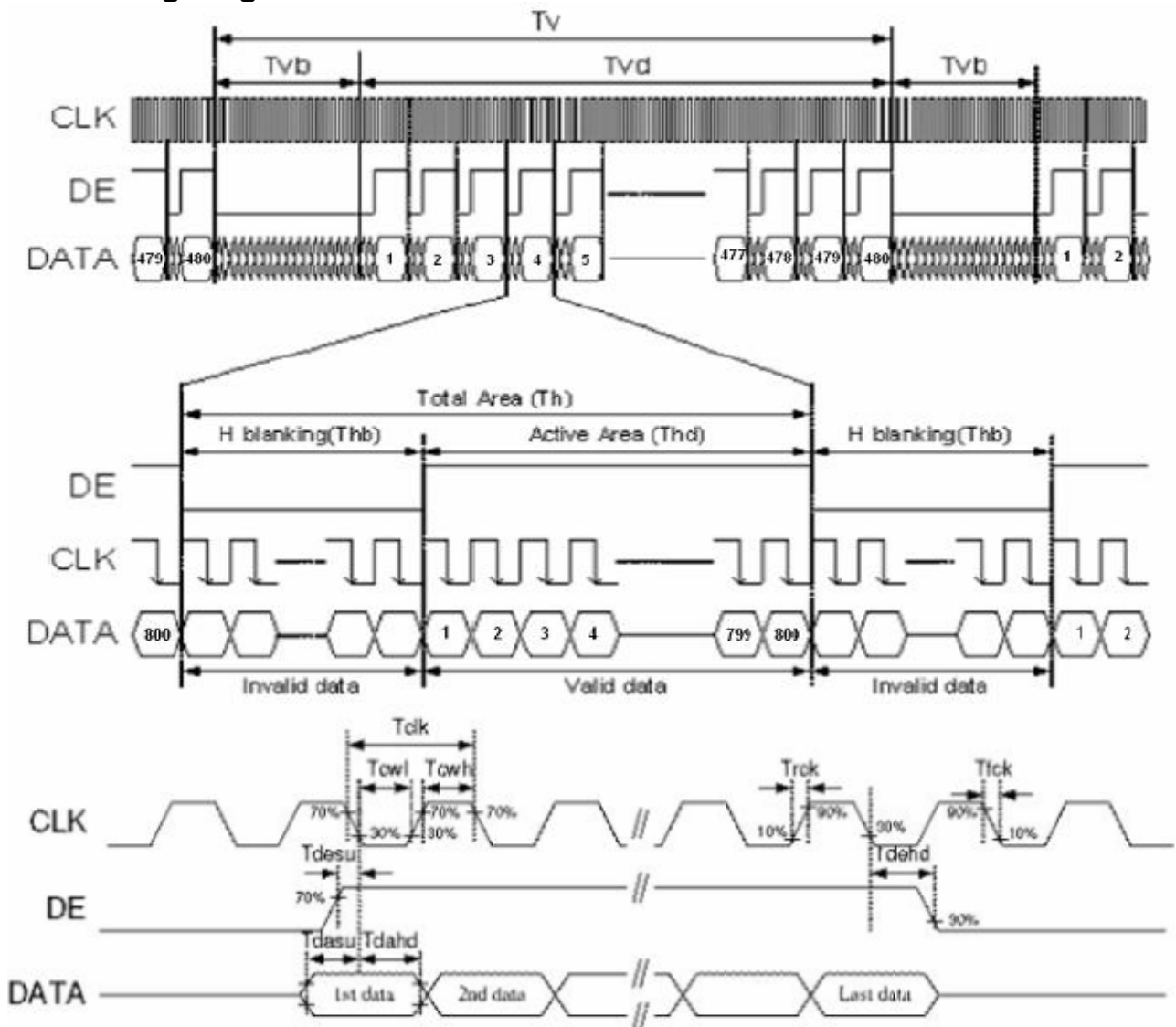

5. Optical Characteristics

Item	Symbol	Condition.	Min	Typ.	Max.	Unit	Remark	
Response time	Tr	$\theta=0^\circ$ 、 $\Phi=0^\circ$	-	10	20	.ms	Note 3	
	Tf		-	15	30	.ms		
Contrast ratio	CR	At optimized viewing angle	400	500	-	-	Note 4	
Color Chromaticity	White	$\theta=0^\circ$ 、 $\Phi=0^\circ$	Wx	0.26	0.31	0.36	-	Note 2,6,7
			Wy	0.28	0.33	0.38		
Viewing angle (Gray Scale Inversion Direction)	Hor.	$CR \geq 10$	Θ_R	60	70	-	Deg.	Note 1
			Θ_L	60	70	-		
	Ver.		Φ_T	40	50	-		
			Φ_B	60	70	-		
Brightness	-	-	650	750	-	cd/m ²	Center of display	
Uniformity	(U)	-	75	-	-	%	Note5	

Ta=25±2°C

Note 1: Definition of viewing angle range

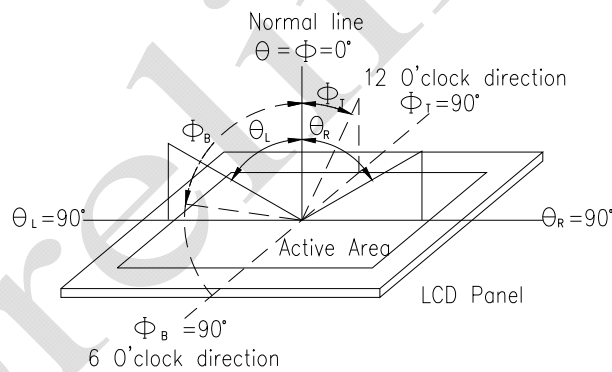

Fig. 6.1. Definition of viewing angle

Note 2: Test equipment setup:

After stabilizing and leaving the panel alone at a driven temperature for 10 minutes, the measurement should be executed. Measurement should be executed in a stable, windless, and dark room. Optical specifications are measured by Topcon BM-7 or BM-5 luminance meter 1.0° field of view at a distance of 50cm and normal direction.

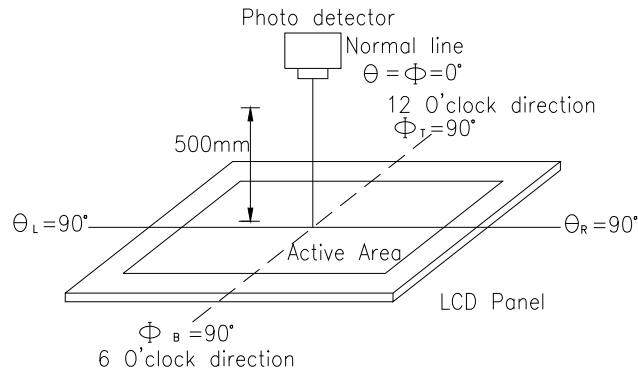
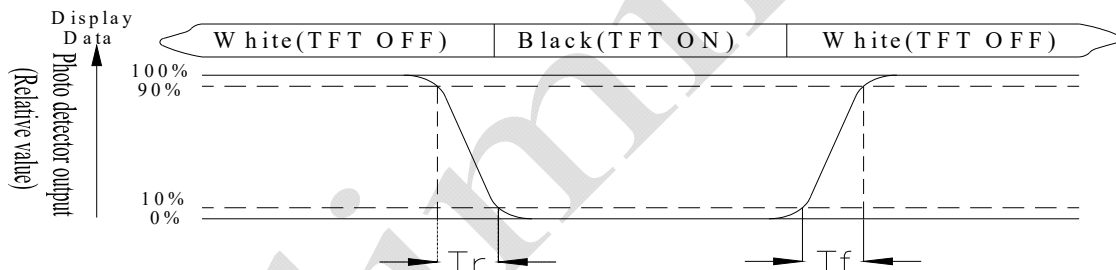

Fig. 6.2. Optical measurement system setup

Note 3: Definition of Response time:

The response time is defined as the LCD optical switching time interval between "White" state and "Black" state. Rise time, T_r , is the time between photo detector output intensity changed from 90% to 10%. And fall time, T_f , is the time between photo detector output intensity changed from 10% to 90%



Note 4: Definition of contrast ratio:

The contrast ratio is defined as the following expression.

$$\text{Contrast ratio (CR)} = \frac{\text{Luminance measured when LCD on the "White" state}}{\text{Luminance measured when LCD on the "Black" state}}$$

Note 5: Definition of Luminance Uniformity

Active area is divided into 9 measuring areas (reference the picture in below). Every measuring point is placed at the center of each measuring area.

$$\text{Luminance Uniformity (U)} = \text{Lmin/Lmax} \times 100\%$$

L = Active area length

W = Active area width

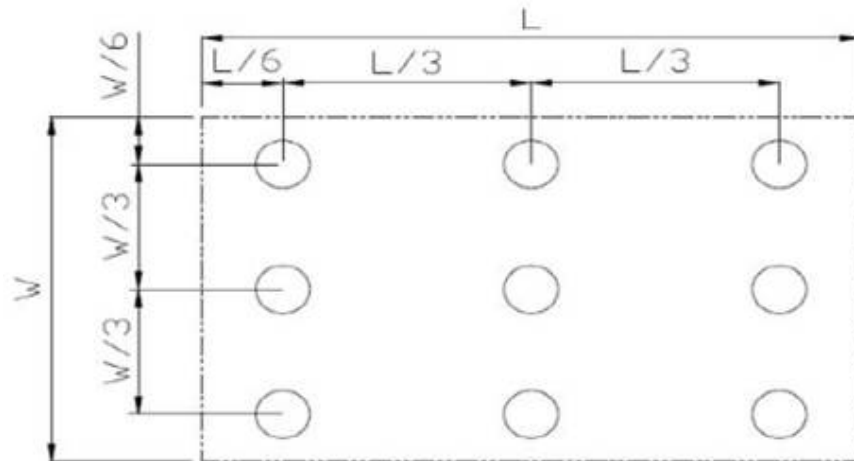

Fig6.3. . Definition of uniformity

Note 6: Definition of color chromaticity (CIE 1931)
Color coordinates measured at the center point of LCD

Note 7: Measured at the center area of the panel when all the input terminals of LCD panel are electrically opened.

6. Interface

6.1. LCM PIN Definition

FPC Connector is used for the module electronics interface. The recommended model is FH19SC-40S-0.5SH manufactured by HIROSE or EA WF050-40S/-40ST

Pin	Symbol	Function	Remark
1	VLED-	Power for LED backlight (Cathode)	
2	VLED+	Power for LED backlight (Anode)	
3	GND	Power Ground	
4	VDD	Power voltage	
5	R0	Red data (LSB)	
6	R1	Red data	
7	R2	Red data	
8	R3	Red data	
9	R4	Red data	
10	R5	Red data	
11	R6	Red data	
12	R7	Red data(MSB)	
13	G0	Green data(LSB)	
14	G1	Green data	
15	G2	Green data	
16	G3	Green data	
17	G4	Green data	
18	G5	Green data	
19	G6	Green data	
20	G7	Green data(MSB)	
21	B0	Blue data(LSB)	
22	B1	Blue data	
23	B2	Blue data	
24	B3	Blue data	
25	B4	Blue data	
26	B5	Blue data	
27	B6	Blue data	
28	B7	Blue data(MSB)	
29	GND	Power Ground	
30	CLK	Sample clock	
31	DISP	Display on/off	
32	HS	Horizontal sync input	
33	VS	Vertical sync input	
34	DE	Data input enable	
35	NC	No connection	
36	GND	Power Ground	
37	NC	No connection	
38	NC	No connection	
39	NC	No connection	
40	NC	No connection	

6.2. PCAP PIN Definition

Pin	Symbol	Function	Remark
1	VSS	Ground for analog circuit	
2	VDDT	Power Supply +3.3V	
3	SCL	I2C clock input I2C clock input	
4	NC	No connect	
5	SDA	I2C data input and output	
6	NC	No connect	
7	/RST	External Reset, Low is active	
8	NC	No connect	
9	/INT	External interrupt to the host	
10	VSS	Ground for analog circuit	

7. Reliability

Content of Reliability Test (Wide temperature, -20°C~70°C)

Environmental Test			
Test Item	Content of Test	Test Condition	Note
High Temperature storage	Endurance test applying the high storage temperature for a long time.	80°C 200hrs	2
Low Temperature storage	Endurance test applying the low storage temperature for a long time.	-30°C 200hrs	1,2
High Temperature Operation	Endurance test applying the electric stress (Voltage & Current) and the thermal stress to the element for a long time.	70°C 200hrs	—
Low Temperature Operation	Endurance test applying the electric stress under low temperature for a long time.	-20°C 200hrs	1
High Temperature/ Humidity Operation	The module should be allowed to stand at 60°C, 90%RH max	60°C, 90%RH 96hrs	1,2
Thermal shock resistance	The sample should be allowed stand the following 10 cycles of operation <div style="text-align: center;"> <p style="text-align: center;">-20°C 25°C 70°C</p> <p style="text-align: center;">30min 5min 30min</p> <p style="text-align: center;">1 cycle</p> </div>	-20°C/70°C 10 cycles	—
Vibration test	Endurance test applying the vibration during transportation and using.	Total fixed amplitude : 1.5mm Vibration Frequency : 10~55Hz One cycle 60 seconds to 3 directions of X,Y,Z for Each 15 minutes	3
Static electricity test	Endurance test applying the electric stress to the terminal.	VS=±600V(contact), ±800v(air), RS=330Ω CS=150pF 10 times	—

Note1: No dew condensation to be observed.

Note2: The function test shall be conducted after 4 hours storage at the normal Temperature and humidity after remove from the test chamber.

Note3: The packing have to including into the vibration testing.

8.Touch Panel Information

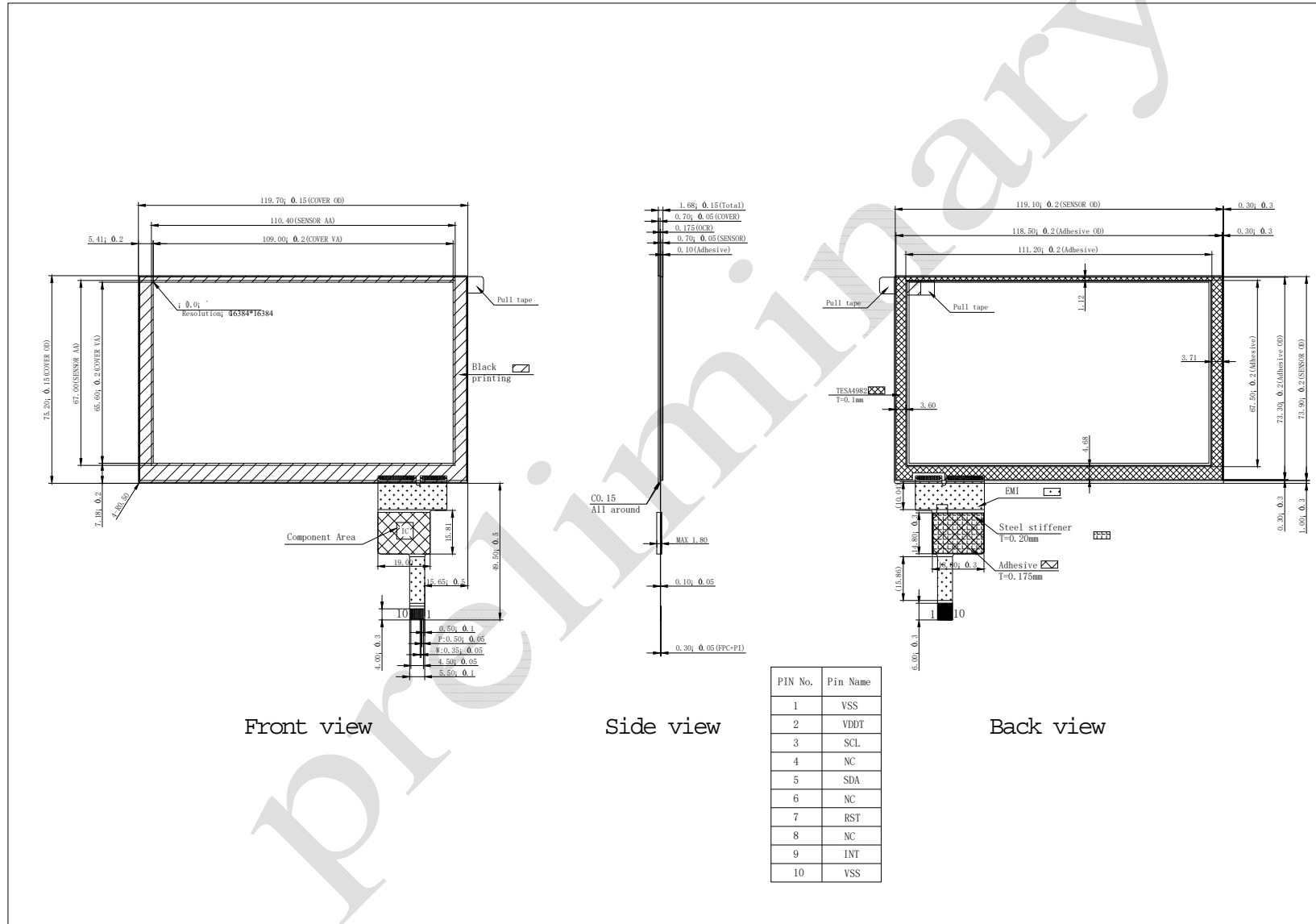

8.1 PCAP controller ILI2130

8.1.1 Device address

The device addresses are 7-binary bits long and are conventionally expressed as 4 bits followed by 3 bits followed by the letter 'b', 1000 001b. These addresses occupy the high seven bits of an eight-bit field on the bus.

MSB							LSB
1	0	0	0	0	0	1	0/1
7-bit Device Address							R/W

7-bit Device Address: 0x41

8-bit Device Address Read: 0x83

8-bit Device Address Write :0x82

8.1.2 I²C AC Characteristics

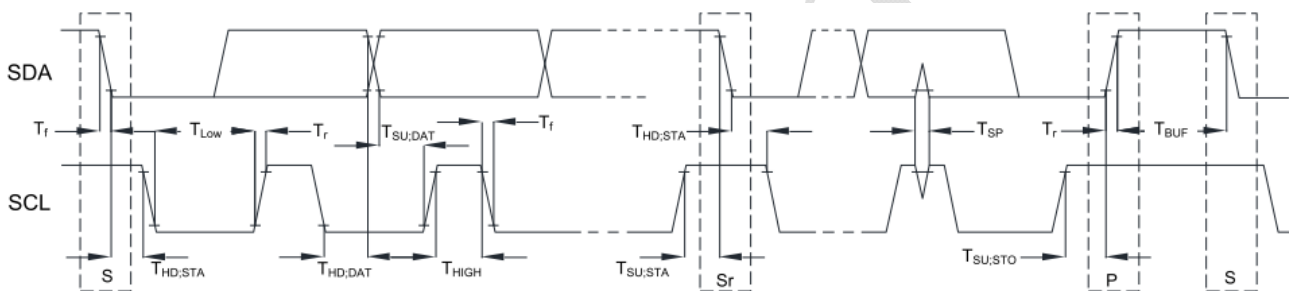

Item	Symbol	100kHz		400kHz		Unit
		Min.	Max.	Min.	Max.	
SCL standard mode clock frequency	F _{SCL}	0	100	0	400	kHz
Hold time (repeated) START condition. After this period, the first clock is generated.	T _{HD;STA}	4	--	0.6	--	us
LOW period of the SCL clock	T _{LOW}	4.7	--	1.3	--	us
HIGH period of the SCL clock	T _{HIGH}	4	--	0.6	--	us
Setup time for a repeat START condition.	T _{SU;STA}	4.7	--	0.6	--	us
Data hold time	T _{HD;DAT}	0	3.45	0	0.9	us
Data setup time	T _{SU;DAT}	250	--	100	--	ns
Rising time of both SDA and SCL signals	T _r	--	1000	--	300	ns
Falling time of both SDA and SCL signals	T _f	--	300	--	300	ns
Setup time for STOP condition.	T _{SU;STO}	4	--	0.6	--	us
Free time between STOP and START condition	T _{BUF}	4.7	--	1.3	--	us
Pulse width of spikes which must be suppressed by input filter	T _{SP}	--	--	0	50	ns

8.2. Power On Sequence

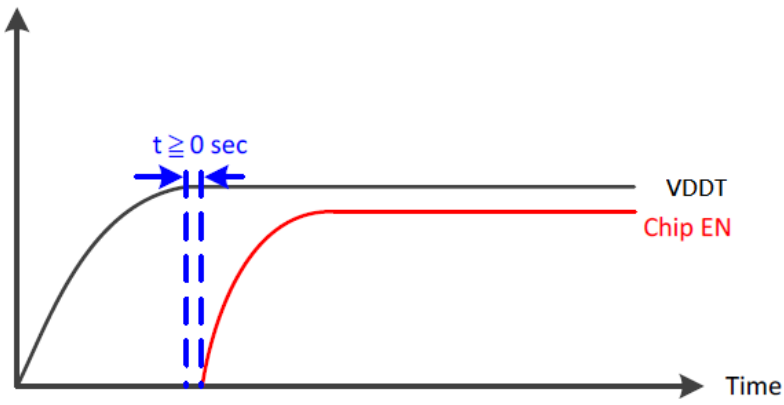

8.3. Power Off to Power On Sequence

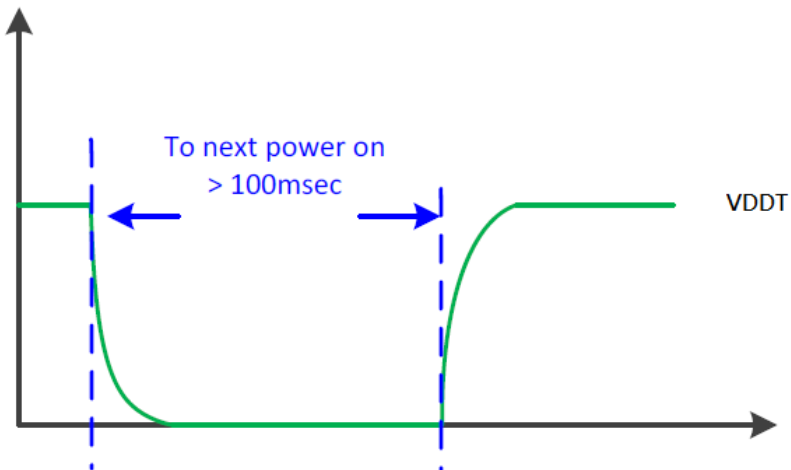

8.4 Code example for PCAP

```
#include "main.h"
//===== By IC =====
unsigned char ILI2130_buf[11];
/*****
 * if touch point add 3~10 finger
 * u can add buf size for add finegr
 * 1 finger point add bufsize[5]
 * finger 1 buf[2~5]
 * finger 2 buf[7~10]
 * finger 3 buf[12~15]
 * finger 4 buf[17~20]
 * finger 5 buf[22~25]
 * finger 6 buf[27~30]
 * finger 7 buf[32~35]
 * finger 8 buf[37~40]
 * finger 9 buf[42~45]
 * finger 10 buf[47~50]
 * 10 finger total 51 buf
 *****/

void CTP_initial_ILI2130(void)
{
    TRISCBits.TRISC4 = 0;    //CTP_SCL
    TRISGBits.TRISG7 = 0;    //CTP_SDA
    TRISABits.TRISA2 = 1;    //CTP_INT
    CNPU3bits.CN35PUE = 1;  //INT_Internal Pull High
}

void I2C_SrCondition(void)
{
    CTP_SCL = 0;
    delay(T4);
    CTP_SDA = 1;
    delay(T4);

    CTP_SCL = 1;
    delay(T4);
    CTP_SDA = 0;
    delay(T4);
}

void I2C_CLK_ILI2130(void)// I2C_SCL Timing
{
    CTP_SCL = 1; //SCL High
    delay(T4); //delay(4)

    CTP_SCL = 0; //SCL Low
    delay(T4); //delay(4)
}
//=====
unsigned char ILI2130_DataRead(void)
{
    unsigned char Data;

    Data = LCD_GetData_I2C();

    return Data ;
}
```

```

//=====
void ILI2130_received_data(void)
{
    unsigned int i;

    //TOUCH DATA
    for(i=0;i<11;i++)
    {
        ILI2130_buf[i]=ILI2130_DataRead();
        CTP_SDA = 0;
        delay(T4);
        I2C_CLK_ILI2130();
    }
    I2C_StopCondition();
}

//=====
unsigned int ILI2130_Get_X1_Value_16bit(void)
{
    unsigned int temp,temp1;

    temp=0;
    if(ILI2130_buf[1]==0x40)
    {
        temp|=ILI2130_buf[3];
        temp1=(temp<<8);
        temp= temp1|ILI2130_buf[2];
    }
    return temp;
}

unsigned int ILI2130_Get_Y1_Value_16bit(void)
{
    unsigned int temp2,temp3;

    temp2=0;
    if(ILI2130_buf[1]==0x40)
    {
        temp2|=ILI2130_buf[5];
        temp3=(temp2<<8);
        temp2= temp3|ILI2130_buf[4];
    }
    return temp2;
}

unsigned int ILI2130_Get_X2_Value_16bit(void)
{
    unsigned int temp,temp1;
    temp=0;
    if(ILI2130_buf[6]==0x41)
    {
        temp|=ILI2130_buf[8];
        temp1=(temp<<8);
        temp= temp1|ILI2130_buf[7];
    }
    return temp;
}

unsigned int ILI2130_Get_Y2_Value_16bit(void)
{
    unsigned int temp2,temp3;

    temp2=0;
    if(ILI2130_buf[6]==0x41)
    {
        temp2|=ILI2130_buf[10];
        temp3=(temp2<<8);
        temp2= temp3|ILI2130_buf[9];
    }

    return temp2;
}

void ILI2130_Communication(void)
{
    I2C_StartCondition();          //s

```

```
LCD_SendAddress(0x82);           //A           write to slave 8
Slave_ack();//1

LCD_SendAddress(0x10); //8
Slave_ack();//1
//I2C_StopCondition();

I2C_SrCondition();
LCD_SendAddress(0x83);           // read slave data
Slave_ack();
}
//=====
```

8.5 Programming guide for PCAP

More information on getting touch data and programming is written here:

https://www.lcd-module.de/eng/pdf/zubehoer/ILI2130_Programming_Guide_V1_50.pdf

8.6 Comparision between ILI2130 and FT5426 (EA TFT050-84ATS)

https://www.lcd-module.de/eng/pdf/zubehoer/ILI2130_comparsion_FT5426.pdf

9. Contour Drawing

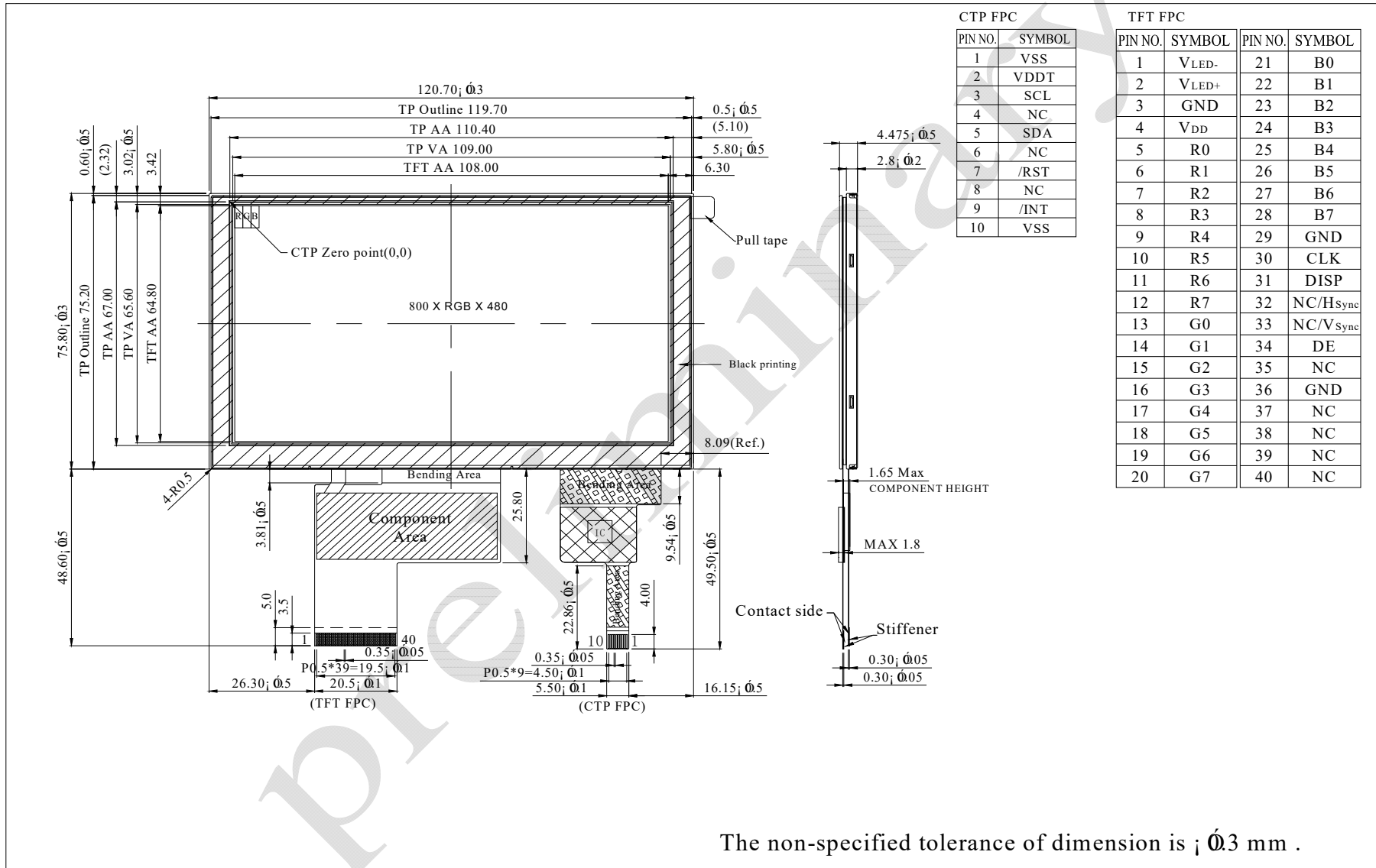

The non-specified tolerance of dimension is ± 0.3 mm .