

亞聲企業有限公司

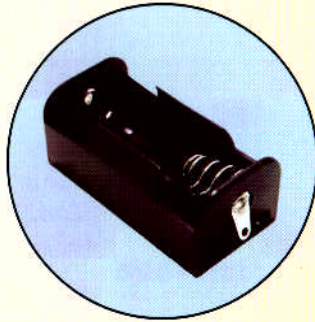

BATTERY HOLDERS

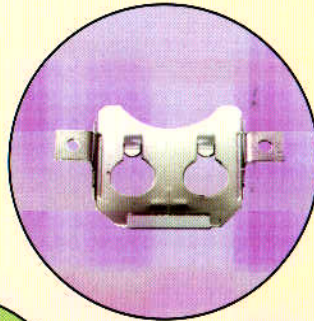

BATTERY CLIPS

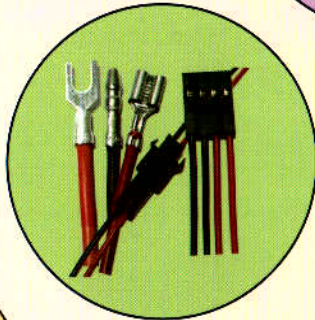

**TERMINAL WIRES &
CONNECTORS**

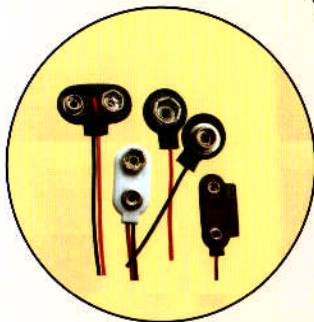

BATTERY SNAPS



**ELECTRONIC
COMPONENTS**

11259台北市北投區大度路3段296巷24號2樓

ACE SOUND ENTERPRISE CO., LTD.

2 FL., NO. 24, LANE 296, SEC. 3, DAH-DUH RD.,
TAIPEI CITY 11259, TAIWAN, R. O. C.

TEL: 886-2-28923642 · 28915444 · 28910944

FAX: 886-2-28951623

E-mail: ace@acesound.com.tw

http: www.acesound.com.tw



ISO 9001
Certificate NO.FM37569

VARIETIES OF TERMINAL : A = WIRE (STANDARD 26AWG 150mm)
 B = SNAP TERMINAL " PP3 " TYPE (STANDARD FEMALE SNAP " 4-PETALS ")
 C = SOLDER LUGS.
 D = P.C. PINS.
 E = SNAP TERMINAL " PP9 " TYPE.

ORDERING CODE :

(EXAMPLE) SN-11-1 **A** = SN-11-1 Dx1 BATTERY HOLDER WITH 26AWG LEAD WIRE 150mm.
 SN-12-1 **B** = SN-12-1 Dx2 BATTERY HOLDER WITH " PP3 " TYPE SNAP TERMINAL
 SN-22-1 **C** = SN-22-1 Cx2 BATTERY HOLDER WITH SOLDER LUGS.
 SN-32-2 **D** = SN-32-2 AxA2 BATTERY HOLDER WITH P.C. PINS
 SN-18-3 **E** = SN-18-3 Dx8 BATTERY HOLDER WITH " PP9 " TYPE SNAP TERMINAL

SN-11-1 / UM-1x1 FOR ONE " D " CELL

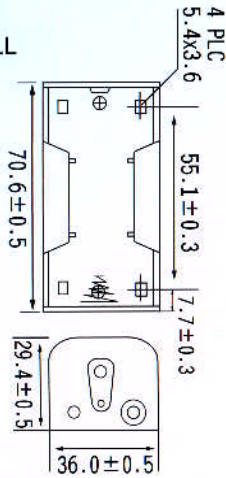

SN-11-1A
 SN-11-1C

SN-12-1 / UM-1x2 FOR TWO " D " CELL

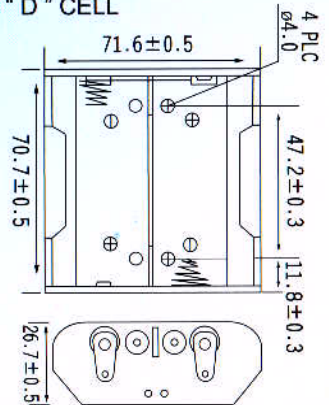

SN-12-1A
 SN-12-1B
 SN-12-1C
 SN-12-1E

SN-14-1 / UM-1x4 FOR FOUR " D " CELL

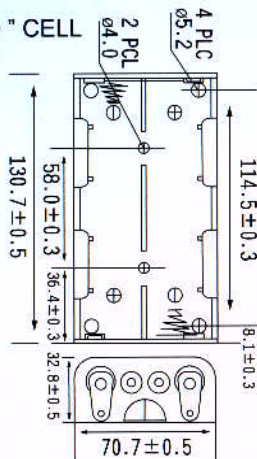
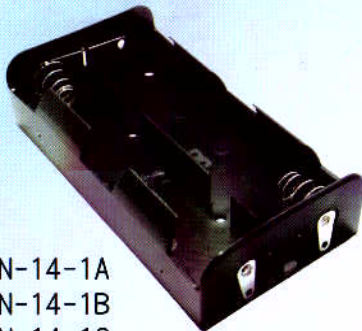

SN-14-1A
 SN-14-1B
 SN-14-1C
 SN-14-1E

SN-14-2 / UM-1x4 FOR FOUR " D " CELL

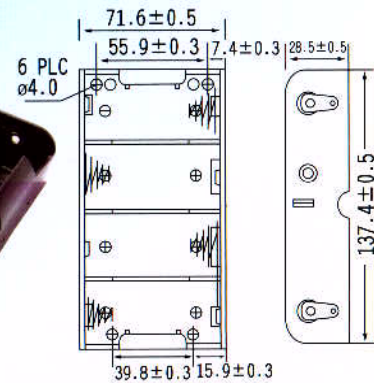

SN-14-2A
 SN-14-2B
 SN-14-2C

SN-16-1 / UM-1x6 FOR SIX " D " CELL

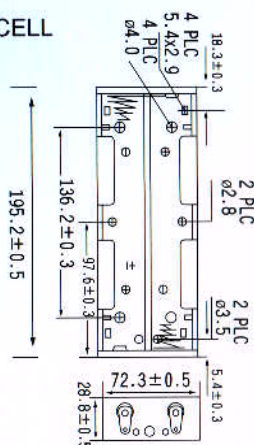

SN-16-1A
 SN-16-1C
 SN-16-1E

SN-18-1 / UM-1x8 FOR EIGHT " D " CELL

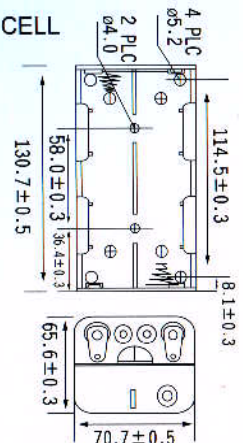
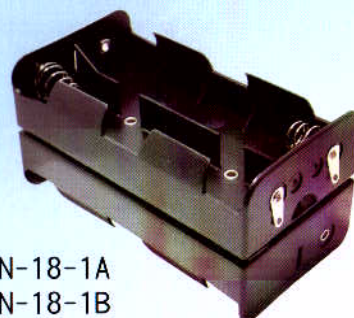

SN-18-1A
 SN-18-1B
 SN-18-1C
 SN-18-1E

SN-18-2 / UM-1x8 FOR EIGHT " D " CELL

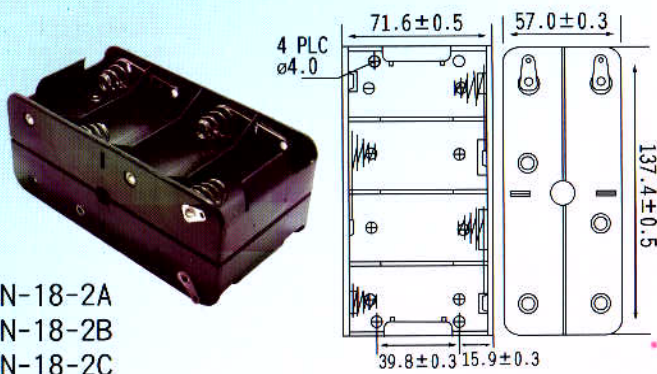

SN-18-2A
SN-18-2B
SN-18-2C

SN-18-3 / UM-1x8 FOR EIGHT " D " CELL

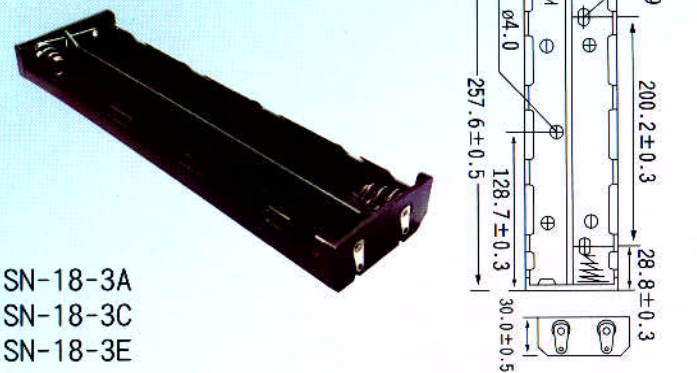

SN-18-3A
SN-18-3C
SN-18-3E

SN-21-1 / UM-2x1 FOR ONE " C " CELL

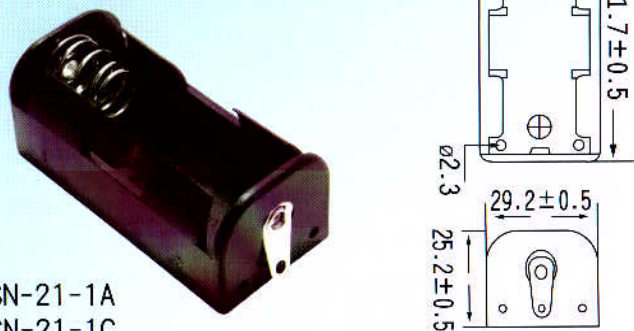

SN-21-1A
SN-21-1C

SN-22-1 / UM-2x2 FOR TWO " C " CELL

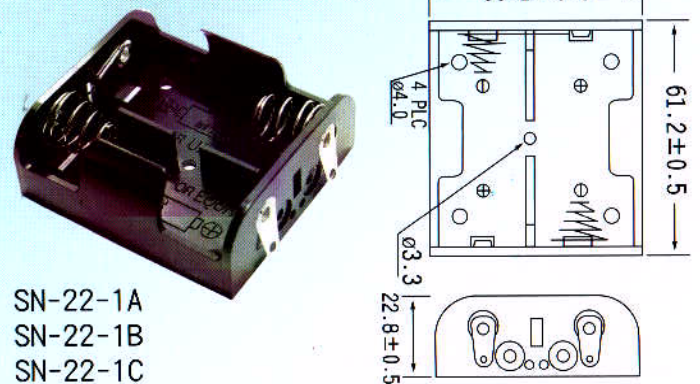

SN-22-1A
SN-22-1B
SN-22-1C

SN-24-1 / UM-2x4 FOR FOUR " C " CELL

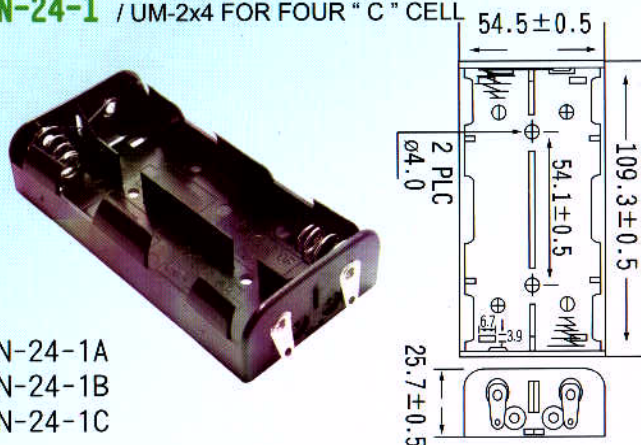

SN-24-1A
SN-24-1B
SN-24-1C

SN-24-2 / UM-2x4 FOR FOUR " C " CELL

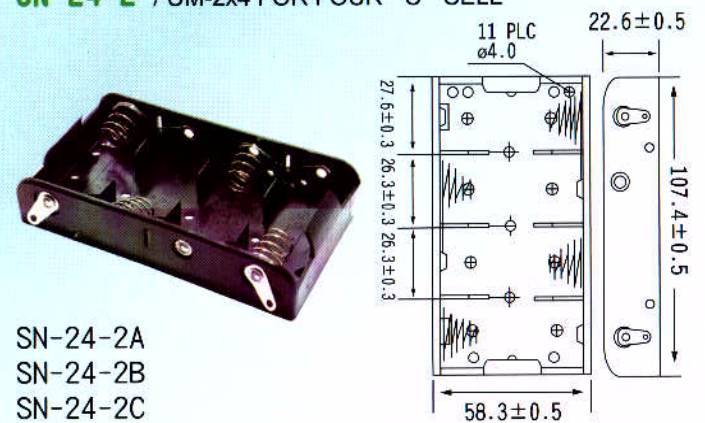

SN-24-2A
SN-24-2B
SN-24-2C

SN-24-3 / UM-2x4 FOR FOUR " C " CELL

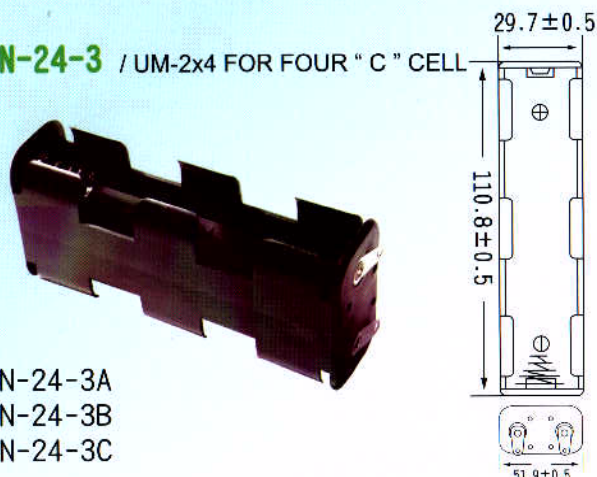

SN-24-3A
SN-24-3B
SN-24-3C

SN-24-4 / UM-2x4 FOR FOUR " C " CELL

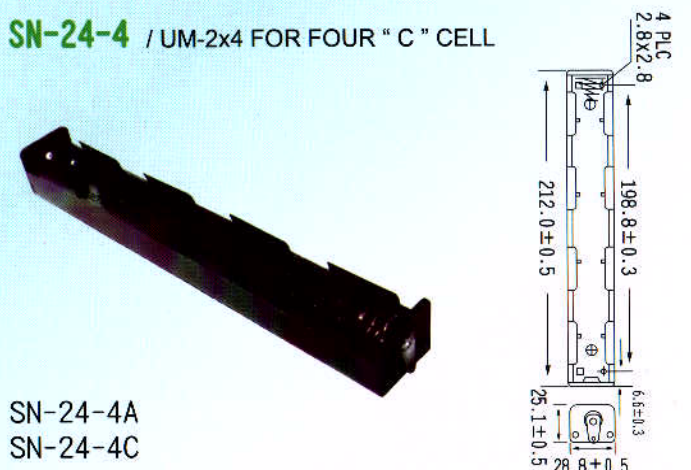

SN-24-4A
SN-24-4C

SN-24-5 / UM-2x4 FOR FOUR "C" CELL

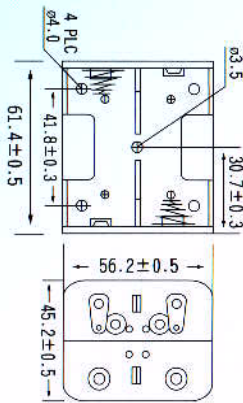

- SN-24-5A
- SN-24-5B
- SN-24-5C

SN-26-1 / UM-2x6 FOR SIX "C" CELL

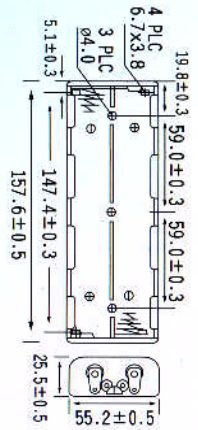

- SN-26-1A
- SN-26-1B
- SN-26-1C

SN-28-1 / UM-2x8 FOR EIGHT "C" CELL

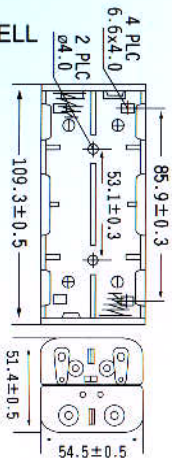

- SN-28-1A
- SN-28-1B
- SN-28-1C

SN-28-2 / UM-2x8 FOR EIGHT "C" CELL

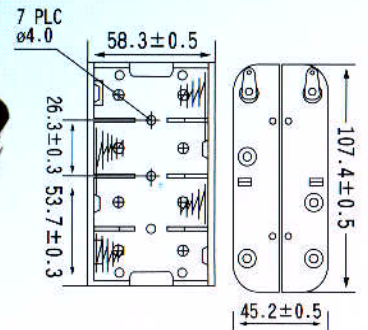

- SN-28-2A
- SN-28-2B
- SN-28-2C

SN-28-3 / UM-2x8 FOR EIGHT "C" CELL

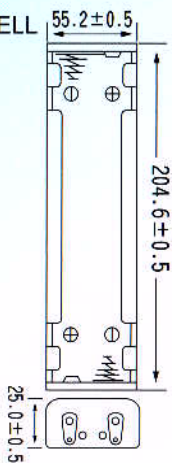

- SN-28-3A
- SN-28-3B
- SN-28-3C

SN-31-1 / UM-3x1 FOR ONE "AA" CELL

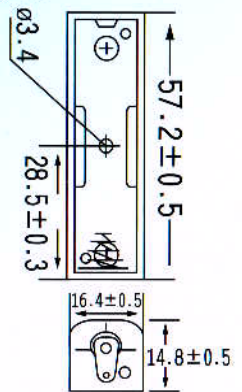

- SN-31-1A
- SN-31-1C
- SN-31-1D

SN-32-1 / UM-3x2 FOR TWO "AA" CELL

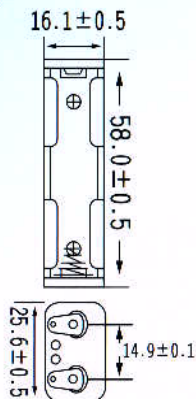
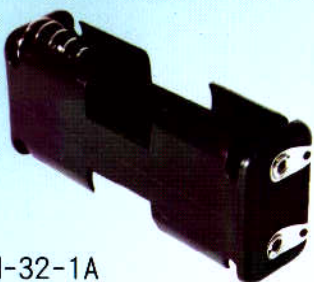

- SN-32-1A
- SN-32-1C
- SN-32-1D

SN-32-2 / UM-3x2 FOR TWO "AA" CELL

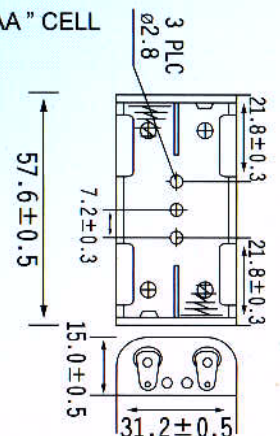
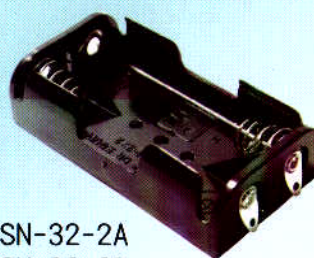

- SN-32-2A
- SN-32-2B
- SN-32-2C
- SN-32-2D

SN-32-4 / UM-3x2 FOR TWO "AA" CELL

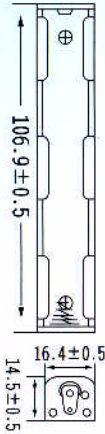

- SN-32-4A
- SN-32-4C
- SN-32-4D

SN-32-5 / UM-3x2 FOR TWO "AA" CELL

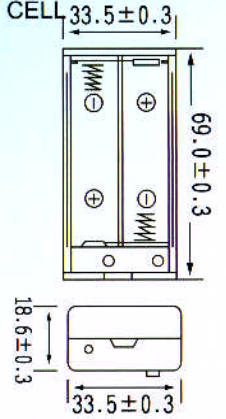
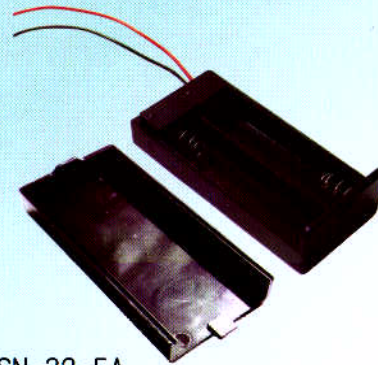

- SN-32-5A

SN-33-1 / UM-3x3 FOR THREE "AA" CELL

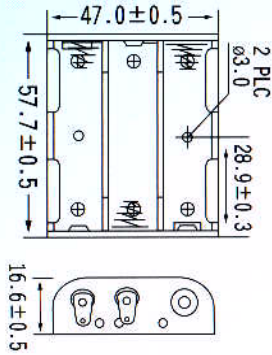

- SN-33-1A
- SN-33-1B
- SN-33-1C
- SN-33-1D

SN-33-2 / UM-3x3 FOR THREE "AA" CELL

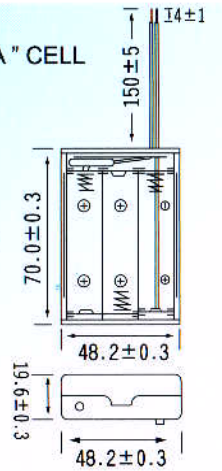

- SN-33-2A

SN-34-1 / UM-3x4 FOR FOUR "AA" CELL

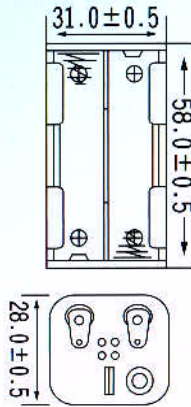
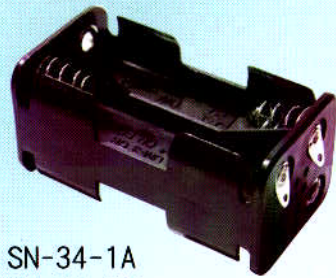

- SN-34-1A
- SN-34-1B
- SN-34-1C
- SN-34-1D

SN-34-2 / UM-3x4 FOR FOUR "AA" CELL

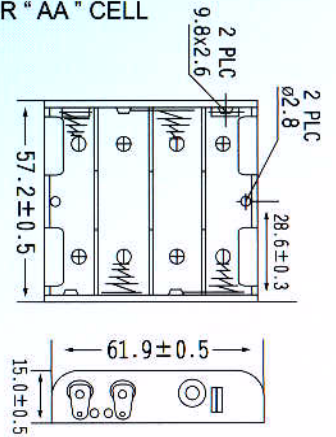
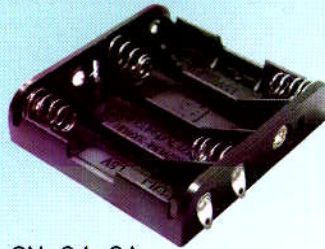

- SN-34-2A
- SN-34-2B
- SN-34-2C
- SN-34-2D

SN-34-3 / UM-3x4 FOR FOUR "AA" CELL

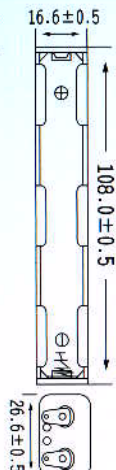
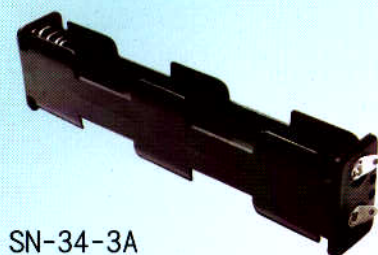

- SN-34-3A
- SN-34-3B
- SN-34-3C
- SN-34-3D

SN-34-4 / UM-3x4 FOR FOUR "AA" CELL

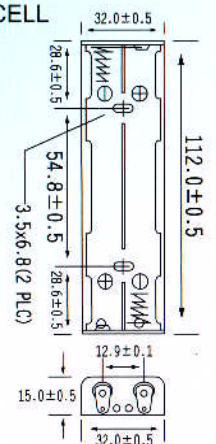
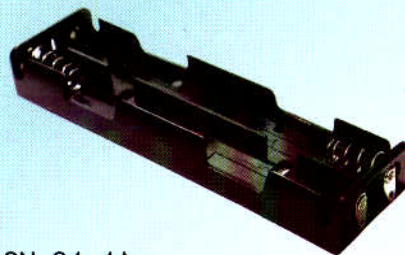

- SN-34-4A
- SN-34-4B
- SN-34-4C
- SN-34-4D

SN-36-1 / UM-3x6 FOR SIX "AA" CELL

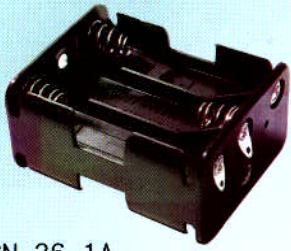

- SN-36-1A
- SN-36-1B
- SN-36-1C
- SN-36-1D

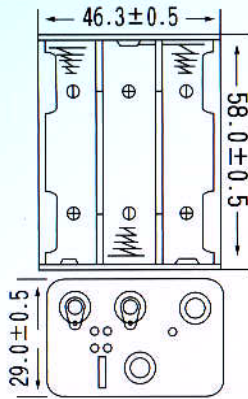

SN-36-2 / UM-3x6 FOR SIX "AA" CELL

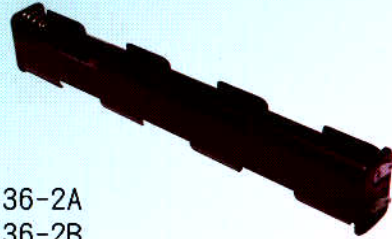

- SN-36-2A
- SN-36-2B
- SN-36-2C
- SN-36-2D

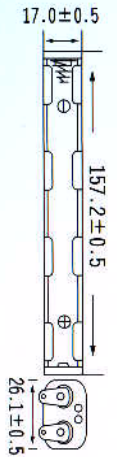

SN-38-1 / UM-3x8 FOR EIGHT "AA" CELL

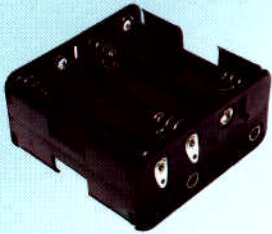

- SN-38-1A
- SN-38-1B
- SN-38-1C
- SN-38-1D

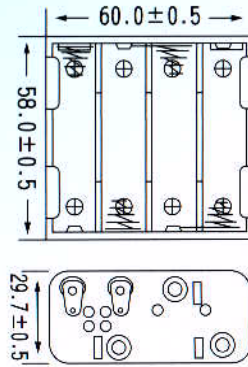

SN-38-2 / UM-3x8 FOR EIGHT "AA" CELL

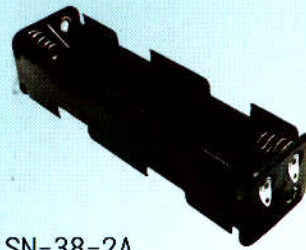

- SN-38-2A
- SN-38-2B
- SN-38-2C
- SN-38-2D

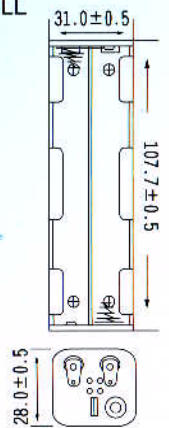

SN-41-1 / UM-4x1 FOR ONE "AAA" CELL

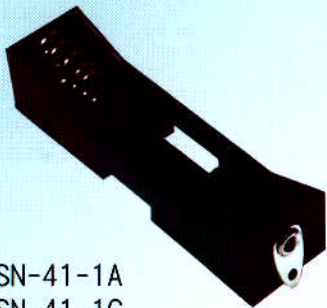

- SN-41-1A
- SN-41-1C
- SN-41-1D

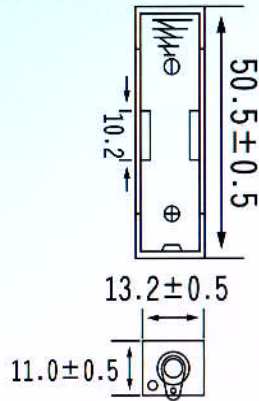

SN-42-1 / UM-4x2 FOR TWO "AAA" CELL

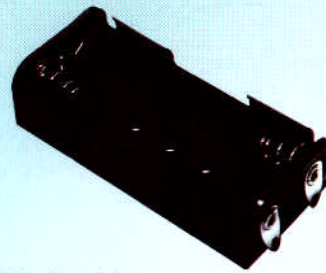

- SN-42-1A
- SN-42-1C
- SN-42-1D

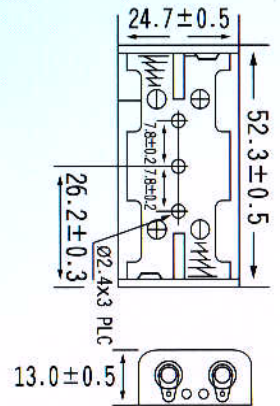

SN-42-2 / UM-4x2 FOR TWO "AAA" CELL

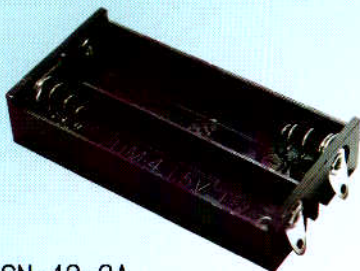

- SN-42-2A
- SN-42-2C
- SN-42-2D

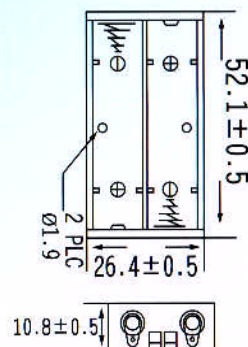

SN-43-1 / UM-4x3 FOR THREE "AAA" CELL

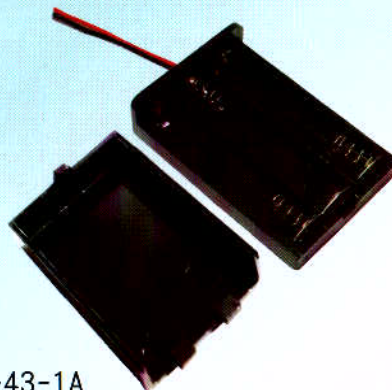

- SN-43-1A

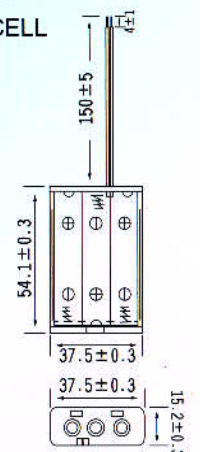

SN-44-1 / UM-4x4 FOR FOUR "AAA" CELL



SN-44-1A
SN-44-1C
SN-44-1D

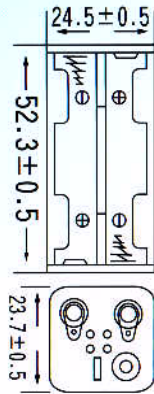

SN-52-1 / UM-5x2 FOR TWO "N" CELL

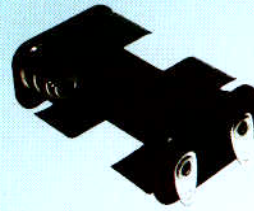

SN-52-1A
SN-52-1B
SN-52-1C
SN-52-1D

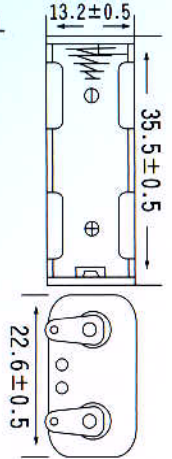

SN-2032-1A / CR2032x1 FOR ONE "CR2032" CELL,
"SMT" TYPE

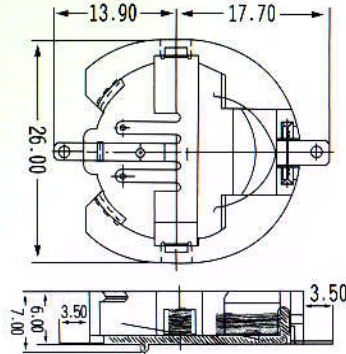
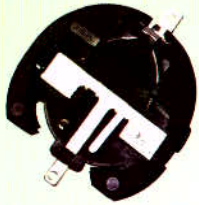

SN-1220-1 / CR1220x1 FOR ONE "CR1220" CELL,
"SMT" TYPE

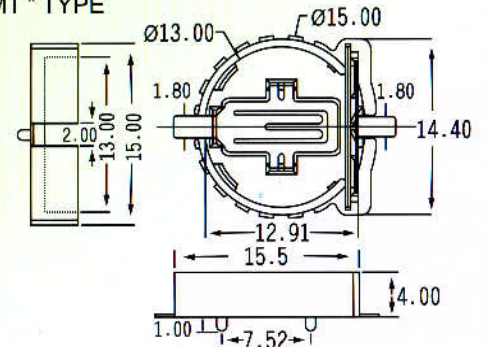

SN-2032-1
/ CR2032x1 FOR ONE
"CR2032" CELL,
"DIP" TYPE



SN-2430-1
/ CR2430x1 FOR ONE
"CR2430" CELL,
"DIP" TYPE

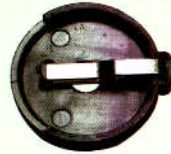

SN-2450-1
/ CR2450x1 FOR ONE
"CR2450" CELL,
"DIP" TYPE

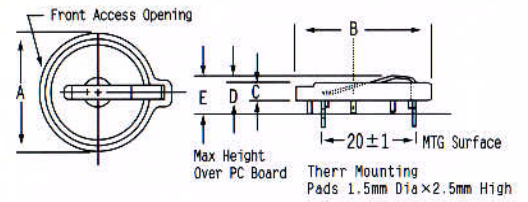

MODELS	A	B	C	D	E
SN-2032-1	22.6	27.3	5.1	7.0	7.4

MODELS	A	B	C	D	E
SN-2430-1	27.7	30.4	4.7	7.2	8.3

MODELS	A	B	C	D	E
SN-2450-1	27.7	30.4	4.7	7.2	10.3

電池夾 BATTERY CLIPS

SN-CP1220

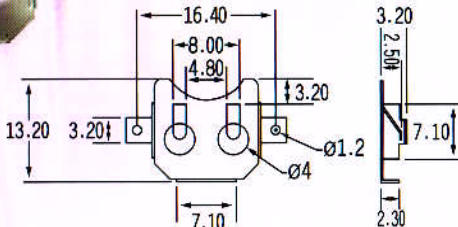

SN-CP2032

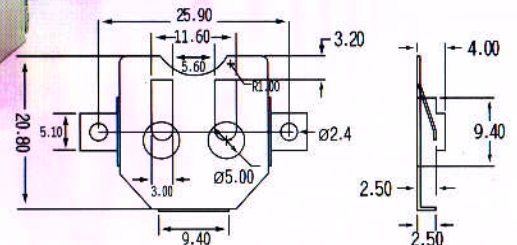

端子線及接頭

TERMINAL WIRES & CONNECTORS

SN-CD1-1

SN-CD1-2

SN-CD1-3

SN-CD1-5

SN-CD2-1

SN-CD2-2

SN-CD2-3



SN-CD2-4

SN-CD2-5

SN-CD3-1

SN-CD3-2

SN-CD3-3

SN-CD3-4

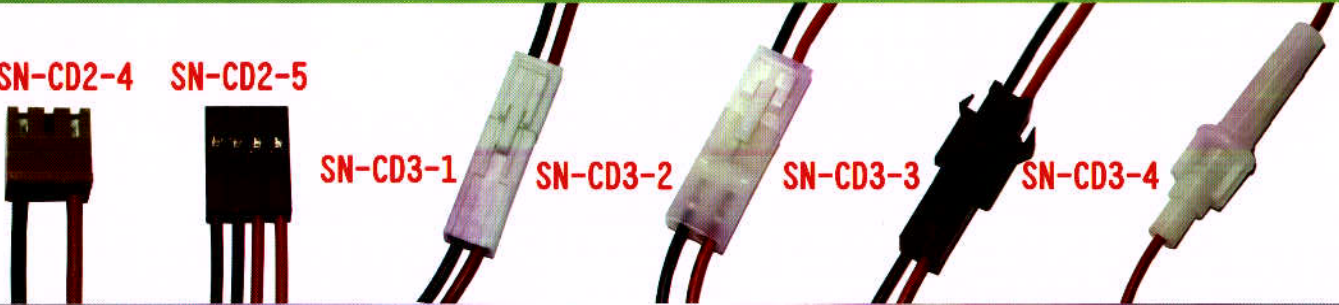

電池扣及9V電池盒

BATTERY SNAPS & 9V BATTERY HOLDERS

SN-1

SN-1-1

SN-2

SN-3

SN-3-1

SN-4

SN-4-2

SN-5

SN-6



SN-9

SN-9-1

SN-9-2

SN-9V-1 / PP3x1 FOR ONE "9V" CELL.

SN-9-3



SN-9V-1A
SN-9V-1C
SN-9V-1D

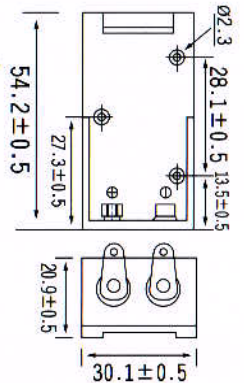
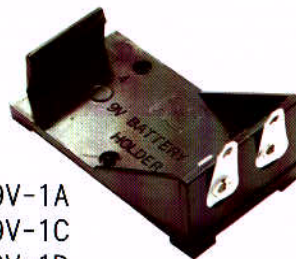

電子零件

ELECTRONIC COMPONENTS

SN-T1

SN-T2

SN-T5

SN-T8

SN-T3

SN-T4

SN-T7

STAMPING PARTS

