

1A, 200V - 1000V Standard Surface Mount Rectifier

FEATURES

- Glass passivated chip junction
- Ideal for automated placement
- Low profile package
- Moisture sensitivity level: level 1, per J-STD-020
- RoHS Compliant
- Halogen-free according to IEC 61249-2-21

APPLICATIONS

- DC to DC converter
- Switching mode converters and inverters
- General purpose

MECHANICAL DATA

- Case: Thin SMA
- Molding compound meets UL 94V-0 flammability rating
- Terminal: Pure tin plated leads, solderable per J-STD-002
- Meet JESD 201 class 2 whisker test
- Polarity: Indicated by cathode band
- Weight: 0.029g (approximately)

KEY PARAMETERS		
PARAMETER	VALUE	UNIT
I_F	1	A
V_{RRM}	200 - 1000	V
I_{FSM}	30	A
T_{JMAX}	150	°C
Package	Thin SMA	
Configuration	Single die	



Thin SMA



ABSOLUTE MAXIMUM RATINGS ($T_A = 25^\circ\text{C}$ unless otherwise noted)								
PARAMETER	SYMBOL	S1DAL	S1GAL	S1JAL	S1KAL	S1MAL	UNIT	
Marking code on the device		S1DAL	S1GAL	S1JAL	S1KAL	S1MAL		
Repetitive peak reverse voltage	V_{RRM}	200	400	600	800	1000	V	
Reverse voltage, total rms value	$V_{R(RMS)}$	140	280	420	560	700	V	
Forward current	I_F	1					A	
Surge peak forward current single half sine wave superimposed on rated load	$t = 8.3\text{ms}$	I_{FSM}					30	A
	$t = 1.0\text{ms}$						100	A
Junction temperature	T_J	-55 to +150					°C	
Storage temperature	T_{STG}	-55 to +150					°C	

THERMAL PERFORMANCE			
PARAMETER	SYMBOL	TYP	UNIT
Junction-to-lead thermal resistance	$R_{\theta JL}$	29	°C/W
Junction-to-ambient thermal resistance	$R_{\theta JA}$	82	°C/W
Junction-to-case thermal resistance	$R_{\theta JC}$	30	°C/W

Thermal Performance Note: Units mounted on PCB (5mm x 5mm Cu pad test board)

ELECTRICAL SPECIFICATIONS ($T_A = 25^\circ\text{C}$ unless otherwise noted)					
PARAMETER	CONDITIONS	SYMBOL	TYP	MAX	UNIT
Forward voltage ⁽¹⁾	$I_F = 0.5\text{A}, T_J = 25^\circ\text{C}$	V_F	0.90	-	V
	$I_F = 1\text{A}, T_J = 25^\circ\text{C}$		0.96	1.10	V
	$I_F = 0.5\text{A}, T_J = 125^\circ\text{C}$		0.78	-	V
	$I_F = 1\text{A}, T_J = 125^\circ\text{C}$		0.85	0.98	V
Reverse current @ rated V_R ⁽²⁾	$T_J = 25^\circ\text{C}$	I_R	-	1	μA
	$T_J = 125^\circ\text{C}$		-	50	μA
Junction capacitance	1MHz, $V_R = 4.0\text{V}$	C_J	8	-	pF

Notes:

1. Pulse test with PW = 0.3ms
2. Pulse test with PW = 30ms

ORDERING INFORMATION		
ORDERING CODE ⁽¹⁾	PACKAGE	PACKING
S1xAL	Thin SMA	14,000 / Tape & Reel

Notes:

1. "x" defines voltage from 200V(S1DAL) to 1000V(S1MAL)

CHARACTERISTICS CURVES

($T_A = 25^\circ\text{C}$ unless otherwise noted)

Fig.1 Forward Current Derating Curve

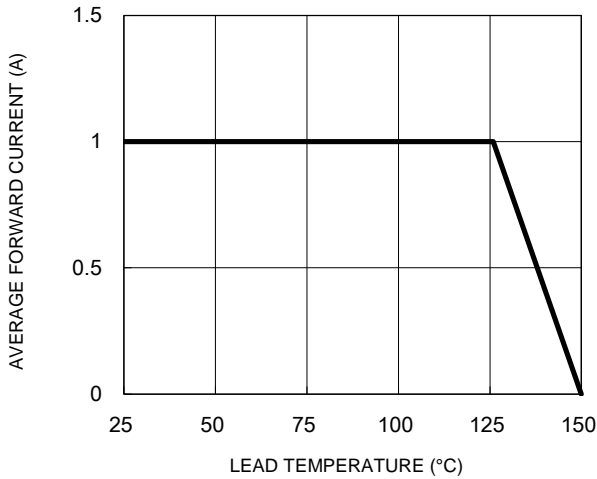

Fig.2 Typical Junction Capacitance

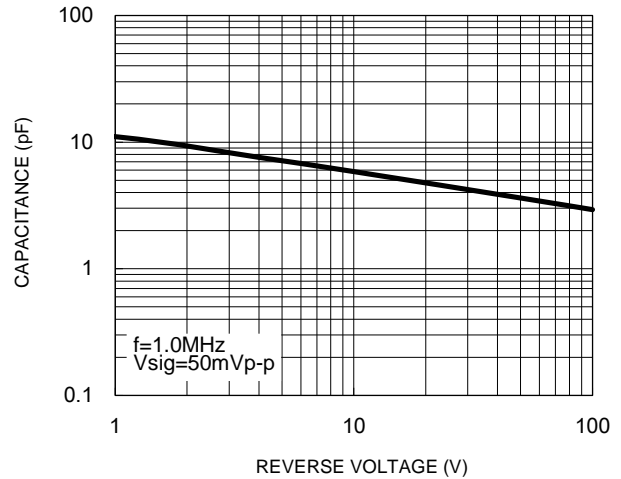

Fig.3 Typical Reverse Characteristics

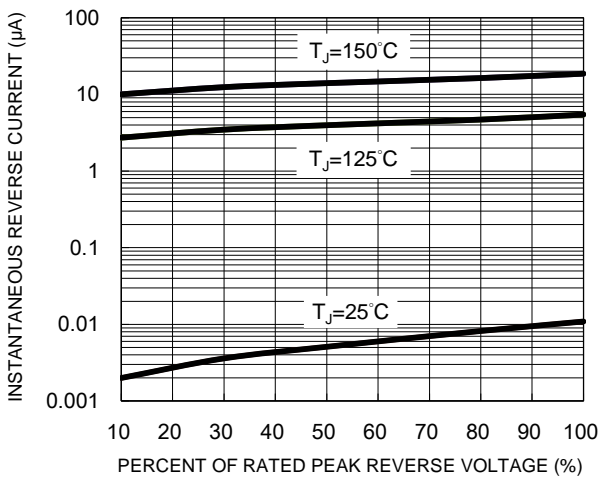

Fig.4 Typical Forward Characteristics

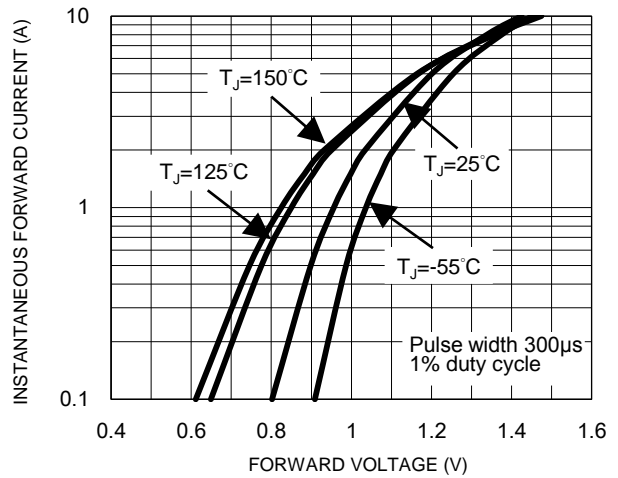
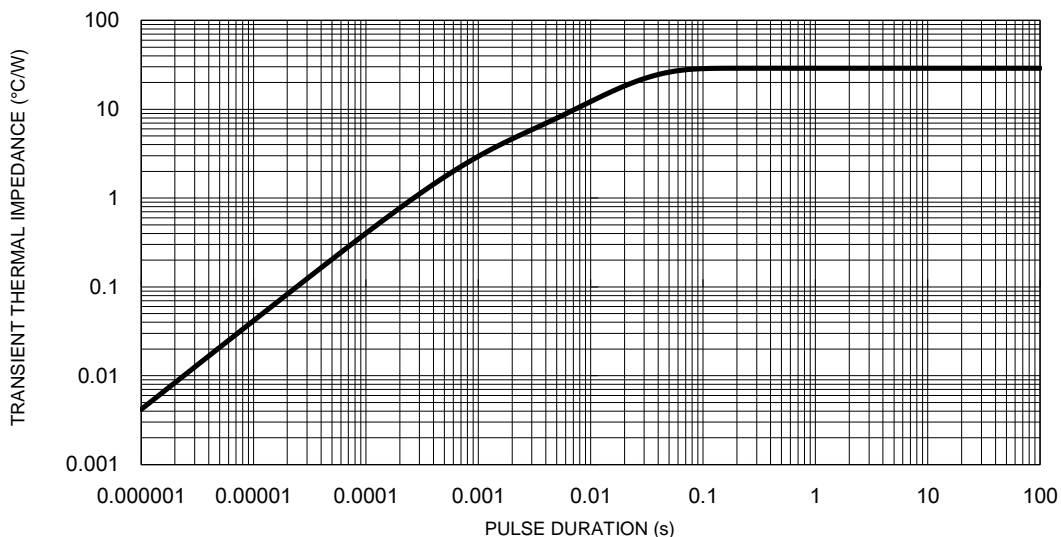
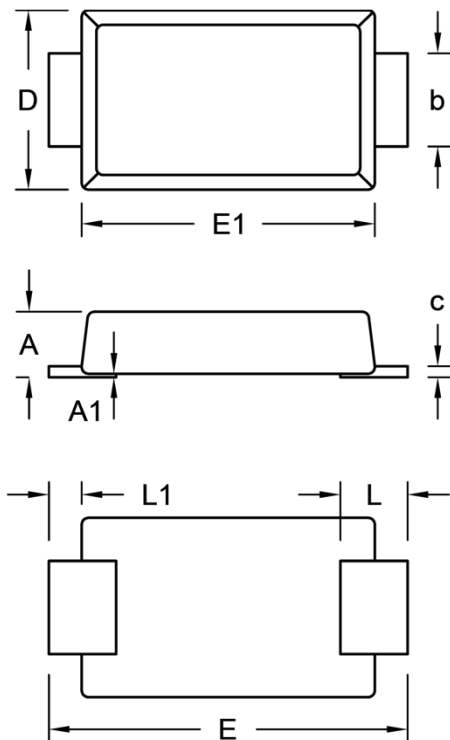

Fig.5 Typical Transient Thermal Impedance



PACKAGE OUTLINE DIMENSIONS

Thin SMA



DIM.	Unit (mm)		Unit (inch)	
	Min.	Max.	Min.	Max.
A	0.90	1.00	0.035	0.039
A1	0.00	0.10	0.000	0.004
b	1.25	1.45	0.049	0.057
c	0.10	0.22	0.004	0.009
D	2.50	2.70	0.098	0.106
E	5.05	5.35	0.199	0.211
E1	4.15	4.35	0.163	0.171
L	0.75	1.20	0.030	0.047
L1	0.30	0.60	0.012	0.024

SUGGESTED PAD LAYOUT

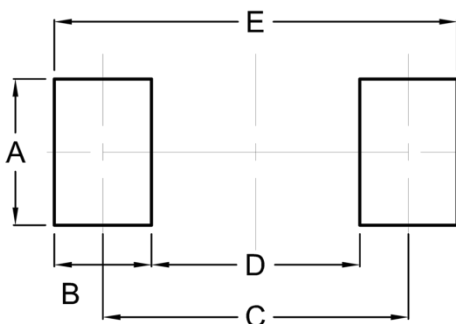

Symbol	Unit (mm)	Unit (inch)
A	2.10	0.083
B	1.40	0.055
C	4.40	0.173
D	3.00	0.118
E	5.80	0.228

MARKING DIAGRAM



P/N = Marking Code
YW = Date Code
F = Factory Code

Notice

Specifications of the products displayed herein are subject to change without notice. TSC or anyone on its behalf, assumes no responsibility or liability for any errors or inaccuracies.

Purchasers are solely responsible for the choice, selection, and use of TSC products and TSC assumes no liability for application assistance or the design of Purchasers' products.

Information contained herein is intended to provide a product description only. No license, express or implied, to any intellectual property rights is granted by this document. Except as provided in TSC's terms and conditions of sale for such products, TSC assumes no liability whatsoever, and disclaims any express or implied warranty, relating to sale and/or use of TSC products including liability or warranties relating to fitness for a particular purpose, merchantability, or infringement of any patent, copyright, or other intellectual property right.

The products shown herein are not designed for use in medical, life-saving, or life-sustaining applications. Customers using or selling these products for use in such applications do so at their own risk and agree to fully indemnify TSC for any damages resulting from such improper use or sale.