

Small Signal Diode

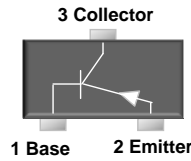

SOT-23

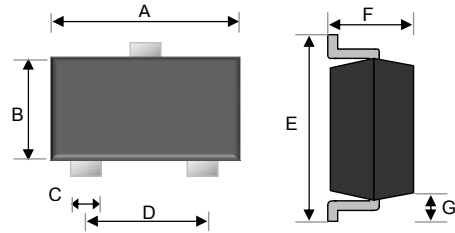

Features

- ✧ Epitaxial planar die construction
- ✧ Surface device type mounting
- ✧ Moisture sensitivity level 1
- ✧ Matte Tin(Sn) lead finish with Nickel(Ni) underplate
- ✧ Pb free version and RoHS compliant
- ✧ Green compound (Halogen free) with suffix "G" on packing code and prefix "G" on date code

Mechanical Data

- ✧ Case : SOT- 23 small outline plastic package
- ✧ Terminal: Matte tin plated, lead free., solderable per MIL-STD-202, Method 208 guaranteed
- ✧ High temperature soldering guaranteed: 260°C/10s
- ✧ Weight : 0.008gram (approximately)
- ✧ Marking Code : 2A

Dimensions	Unit (mm)		Unit (inch)	
	Min	Max	Min	Max
A	2.70	3.10	0.106	0.122
B	1.20	1.65	0.047	0.065
C	0.30	0.50	0.012	0.020
D	1.78	2.04	0.070	0.080
E	2.20	3.00	0.087	0.118
F	0.95	1.40	0.037	0.055
G	0.550 REF		0.022 REF	

Ordering Information

Package	Part No.	Packing	Marking
SOT-23	MMBT3906 RF	3K / 7" Reel	2A
SOT-23	MMBT3906 RFG	3K / 7" Reel	2A

Suggested PAD Layout

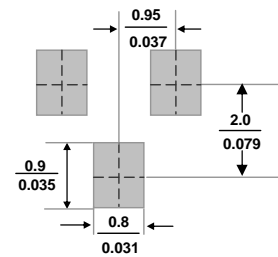

Maximum Ratings and Electrical Characteristics

Rating at 25°C ambient temperature unless otherwise specified.

Maximum Ratings

Type Number	Symbol	Value	Units
Power Dissipation	P_D	350	mW
Collector-Base Voltage	V_{CBO}	-40	V
Collector-Emitter Voltage	V_{CEO}	-40	V
Emitter-Base Voltage	V_{EBO}	-5	V
Collector Current	I_C	-200	mA
Thermal resistance junction-ambient	R_{thJA}	357	°C/W
Junction and Storage Temperature Range	T_J, T_{STG}	-55 to + 150	°C

Notes:1. Valid provided that electrodes are kept at ambient temperature

Small Signal Diode

Electrical Characteristics

Type Number			Symbol	Min	Max	Units	
Collector-Base Breakdown Voltage	$I_C = -10\mu A$	$I_E = 0$	$V_{(BR)CBO}$	-40	-	V	
Collector-Emitter Breakdown Voltage	$I_C = -1mA$	$I_B = 0$	$V_{(BR)CEO}$	-40	-	V	
Emitter-Base Breakdown Voltage	$I_E = -10\mu A$	$I_C = 0$	$V_{(BR)EBO}$	-5	-	V	
Collector Base Cut-off Current	$V_{CB} = -30V$		I_{CBO}	-	-50	nA	
Emitter Base Cut-off Current	$V_{EB} = -6V$		I_{EBO}	-	-50	nA	
DC current gain	$V_{CE} = -1V$	$I_C = -0.1mA$	h_{FE}	60	300		
	$V_{CE} = -1V$	$I_C = -1mA$		80			
	$V_{CE} = -1V$	$I_C = -10mA$		100			
	$V_{CE} = -1V$	$I_C = -50mA$		60			
	$V_{CE} = -1V$	$I_C = -100mA$		30			
Collector-Emitter saturation voltage	$I_C = -10mA$	$I_B = -1mA$	$V_{CE(sat)}$	-	-0.25	V	
	$I_C = -50mA$	$I_B = -5mA$		-	-0.4		
Base-Emitter saturation voltage	$I_C = -10mA$	$I_B = -1mA$	$V_{BE(sat)}$	-0.65	-0.85	V	
	$I_C = -50mA$	$I_B = -5mA$		-	-0.95		
Gain-bandwidth product	$V_{CE} = -20V$	$I_C = -10mA$	$f = 100MHz$	f_T	250	-	MHz
Output capacitance	$V_{CB} = -5V$	$I_E = 0$	$f = 1MHz$	C_{obo}	-	4.5pF	
Delay time	$V_{CC} = -3V$	$V_{BE} = -0.5V$	$I_C = -10mA$	t_d	-	35	nS
Rise time			$I_{B1} = -1.0mA$	t_r	-	35	nS
Storage time	$V_{CC} = -3V$		$I_C = -10mA$	t_s	-	225	nS
Fall time			$I_{B1} = I_{B2} = -1.0mA$	t_f	-	75	nS

Tape & Reel specification

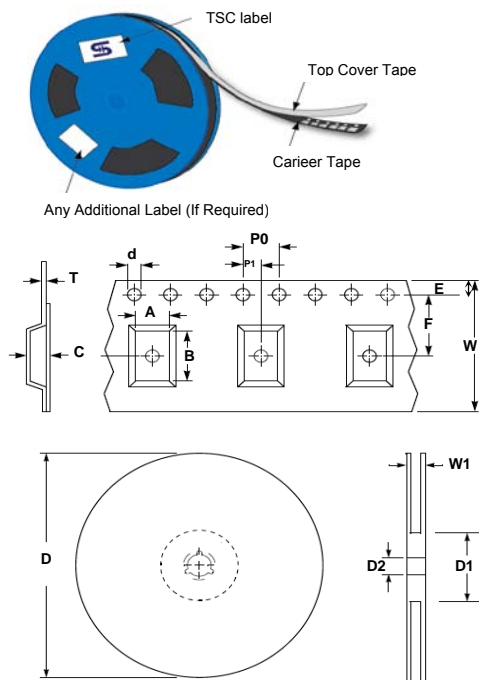

Item	Symbol	Dimension(mm)
Carrier width	A	3.15 ±0.10
Carrier length	B	2.77 ±0.10
Carrier depth	C	1.22 ±0.10
Sprocket hole	d	1.50 ± 0.10
Reel outside diameter	D	178 ± 1
Reel inner diameter	D1	55 Min
Feed hole width	D2	13.0 ± 0.20
Sprocket hole position	E	1.75 ±0.10
Punch hole position	F	3.50 ±0.05
Sprocket hole pitch	P0	4.00 ±0.10
Embossment center	P1	2.00 ±0.05
Overall tape thickness	T	0.229 ±0.013
Tape width	W	8.10 ±0.20
Reel width	W1	12.30 ±0.20

Small Signal Transistor

Rating and Characteristic Curves

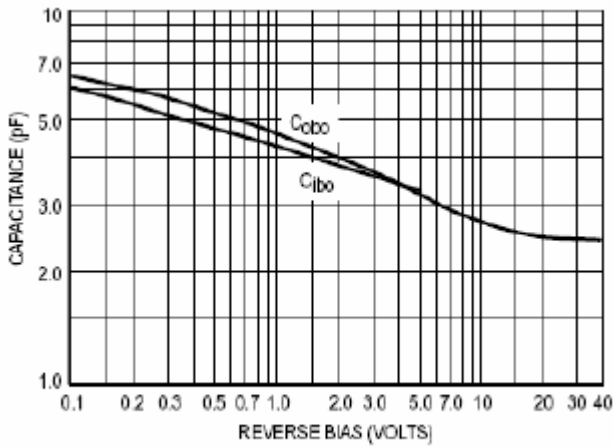

Figure 1 Capacitance

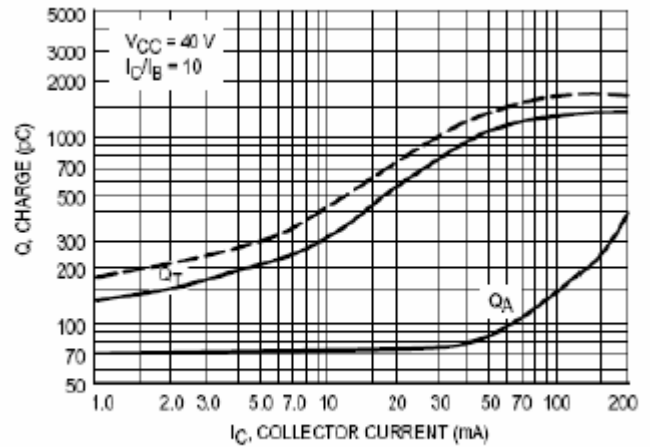

Figure 2 Charge Data

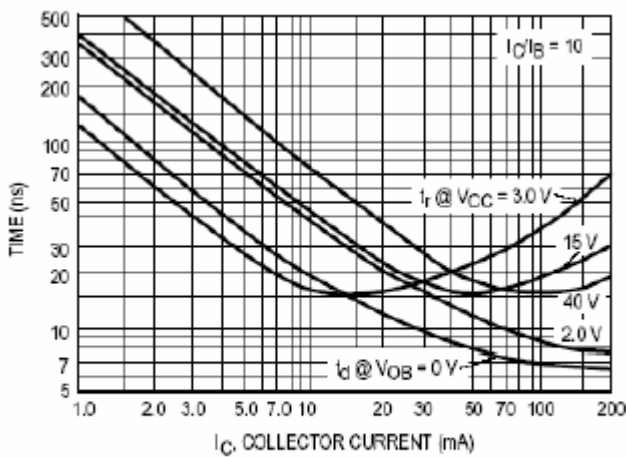

Figure 3 Turn-On Time

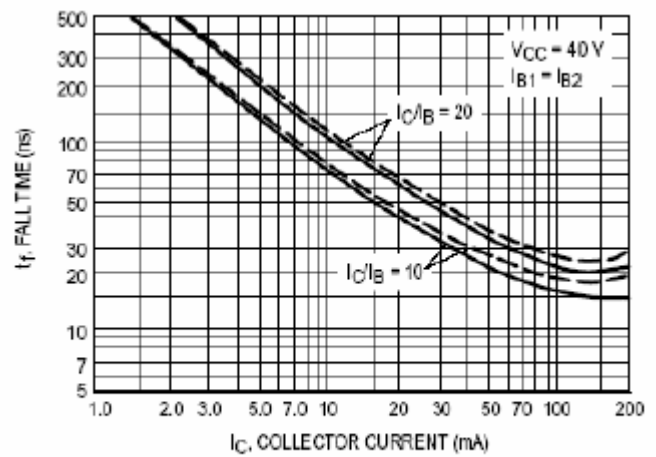

Figure 4 Fall Time

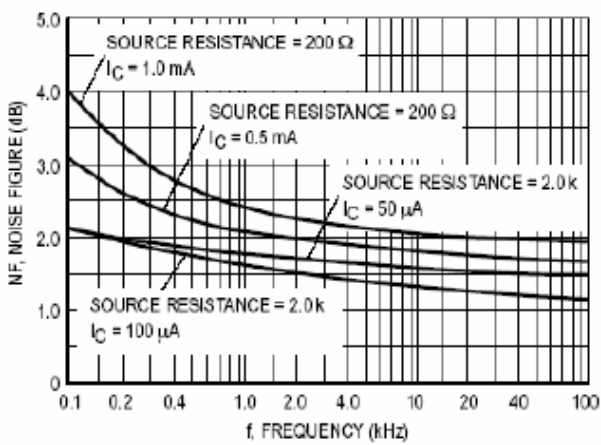

Figure 5

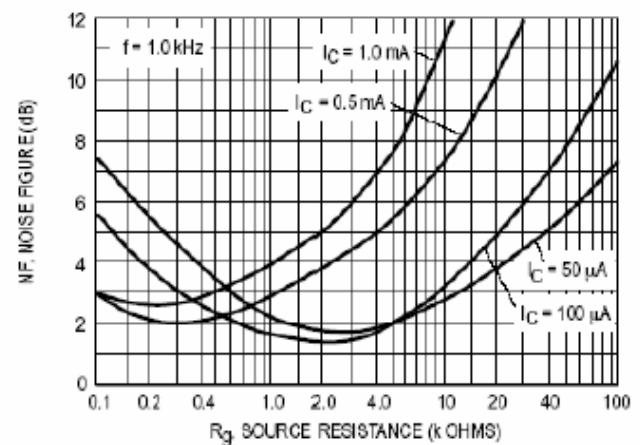

Figure 6

Small Signal Diode

Rating and Sharacteristic Curves

h PARAMETERS

($V_{CE} = -10\text{ Vdc}$, $f = 1.0\text{ kHz}$, $T_A = 25^\circ\text{C}$)

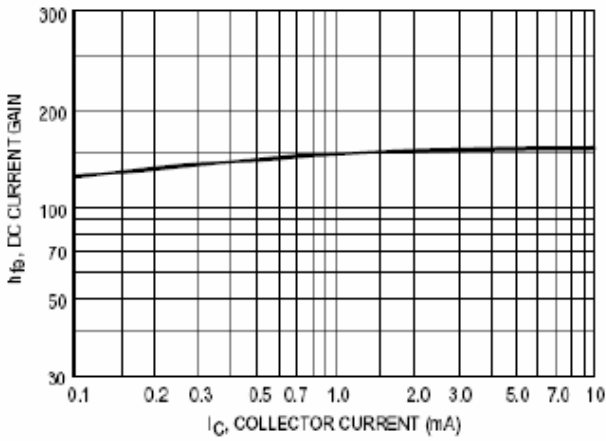

Figure 7 Current Gain

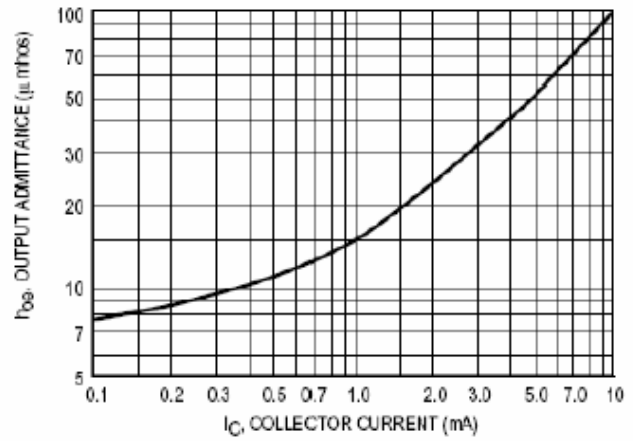

Figure 8 Output Admittance

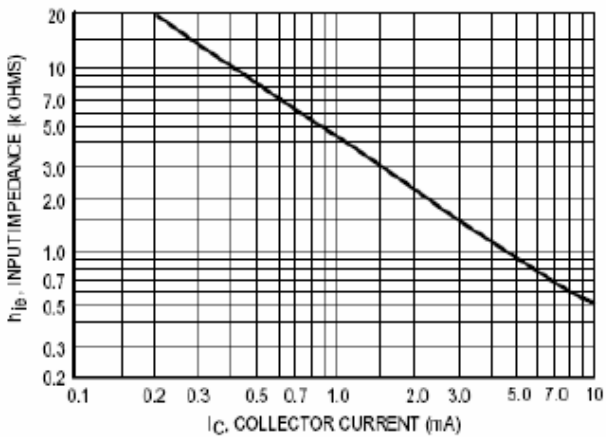

Figure 9 Input Impedance

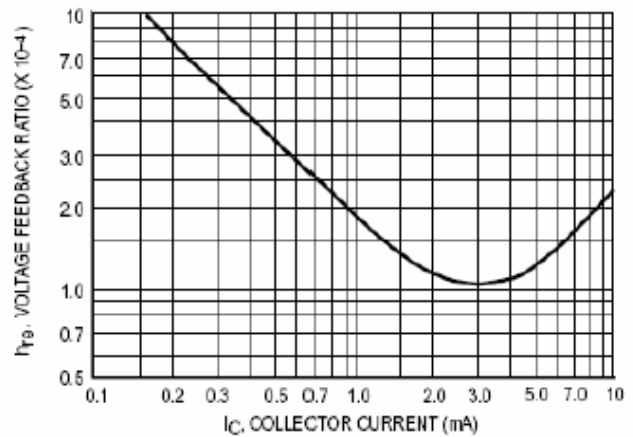

Figure 10 Voltage Feedback Ratio

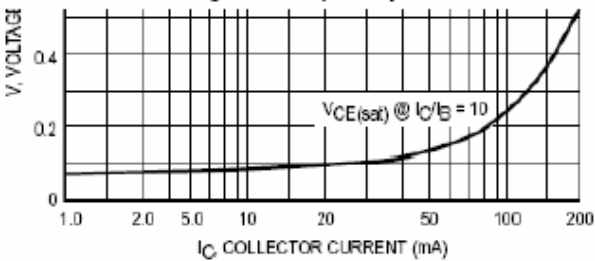

Figure 11 "ON" Voltages

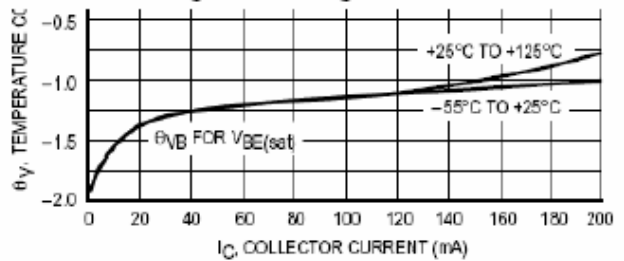

Figure 12 Temperature Coefficients