



Elektrotechnik Karl-Heinz Mauz GmbH

LSM-57A (Artikel-Nr. 120060)

EKULIT

SPECIFICATIONS:

TYPE	UNIT	LSM-57A
Impedance	Ω	$8 \pm 15\%$
Power (Nominal)	W	0.25
Power (Maximum)	W	0.5
Resonant Frequency	Hz	$450 \pm 20\%$
Sound Pressure Level	dB	85 ± 3
Frequency Range	Hz	Fo~4.000
Operating Temperature	$^{\circ}\text{C}$	-20~+60
Storage Temperature	$^{\circ}\text{C}$	-30~+70

DIMENSIONS :

(Unit: mm)

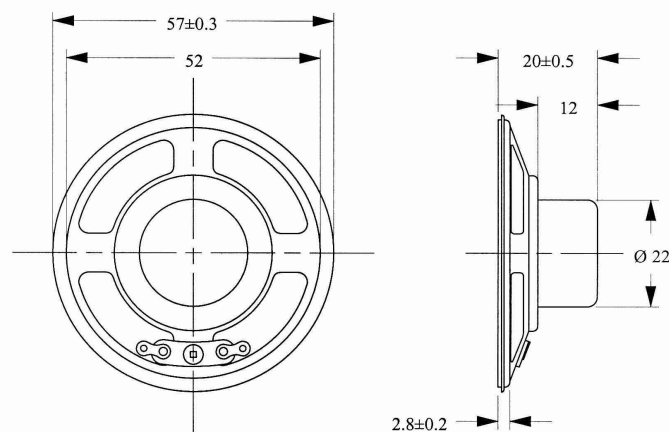

Frequency response:

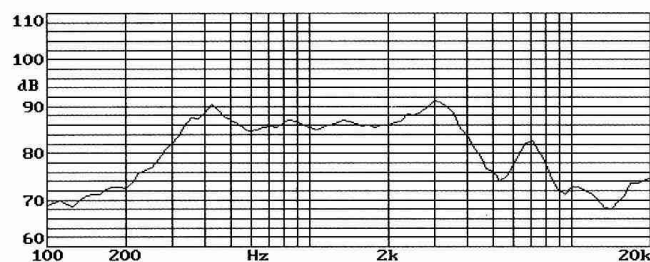

Adresse: **Felix-Wankel-Str. 35 • 73760 Ostfildern/Nellingen**

Tel: **+49-711/3414023**

Fax: **+49-711/3414024**

E-mail: **info@ekulit.de** Web site: **www.EKULIT.de**