



Photocoupler

Product Data Sheet

LTV-305X

Spec No.: DS70-2014-0079

Effective Date: 07/15/2016

Revision: B

LITE-ON DCC

RELEASE

BNS-OD-FC001/A4

Photocoupler LTV-305X series

1. DESCRIPTION

1.1 Features

- Isolation voltage between input and output V_{iso} : 3,750Vrms
- 4pin MFP non zero-cross optoisolators triac driver output
- High repetitive peak off-state voltage V_{DRM} : Min. 600V
- High critical rate of rise of off-state voltage (dV/dt : MIN. 1000V / μs)
- Mini-flat package :
2.0mm profile : LTV-3050, LTV-3051, LTV-3052, LTV-3053
- Safety approval
UL 1577
cUL CA5A
VDE DIN EN60747-5-5 (VDE 0884-5)
- RoHS Compliance
All materials be used in device are followed EU RoHS directive (No.2002/95/EC).
- ESD pass HBM 8000V / MM2000V
- MSL class1

1.2 Applications

- Motor Controls
- Solid state relays
- For triggering high power thyristor and triac
- Household use equipment

Photocoupler LTV-305X series

2. PACKAGE DIMENSIONS

2.1 LTV-305X series

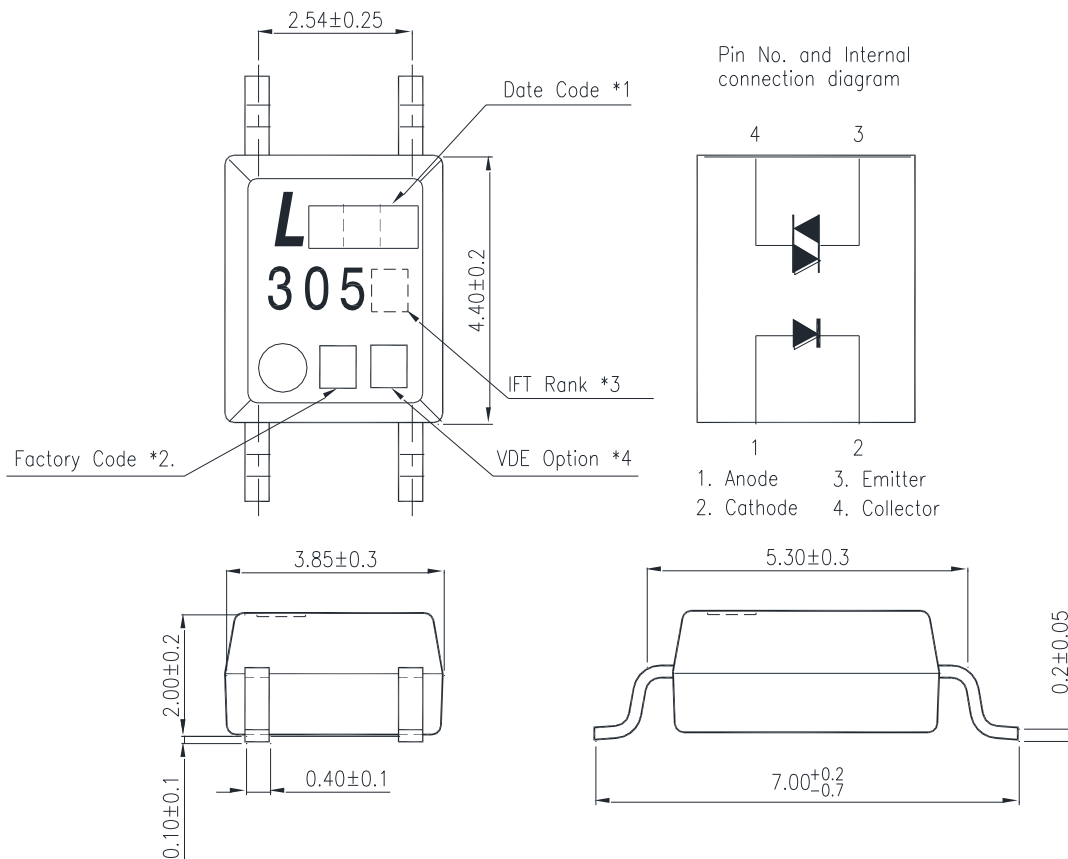

Notes :

1. 1-digit Year date code, 2-digit work week.
2. Factory identification mark shall be marked (X: China -TJ)
3. I_{FT} Rank
4. "4" or "V" for VDE option.

*All dimensions in millimeters.

Photocoupler LTV-305X series

3. TAPING DIMENSIONS

3.1 LTV-305X-TP

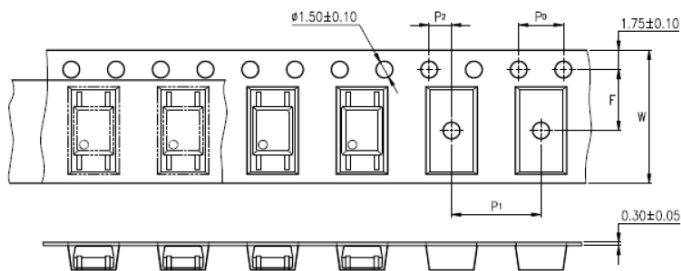

3.2 LTV-305X

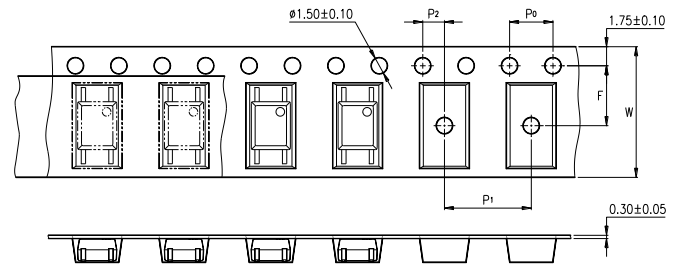

Description	Symbol	Dimension in mm (inch)
Tape wide	W	12±0.3 (0.472)
Pitch of sprocket holes	P ₀	4±0.1 (0.157)
Distance of compartment	F	5.5±0.1 (0.217)
	P ₂	2±0.1 (0.079)
Distance of compartment to compartment	P ₁	8±0.1 (0.315)

3.3 Quantities Per Reel

Package Type	LTV-305X series
Quantities (pcs)	3000

Photocoupler LTV-305X series

4. RATING AND CHARACTERISTICS

4.1 Absolute Maximum Ratings at Ta=25°C

	Parameter	Symbol	Rating	Unit
Input	Forward Current	I_F	50	mA
	Reverse Voltage	V_R	6	V
	Power Dissipation	P_D	70	mW
	Junction Temperature	T_J	125	°C
Output	Off-State Output Terminal Voltage	V_{DRM}	600	V
	Peak Repetitive Surge Current (PW=1ms, 120pps)	V_{TSM}	1	A
	Collector Power Dissipation	P_C	300	mW
	Junction Temperature	T_J	125	°C
	Total Power Dissipation	P_{tot}	330	mW
*1.	Isolation Voltage	V_{iso}	3750	V_{rms}
	Ambient Operating Temperature Range	T_A	-55 ~ +115	°C
	Storage Temperature	T_{stg}	-55 ~ +150	°C
*2.	Soldering Temperature	T_L	260	°C

*1. AC For 1 Minute, R.H. = 40 ~ 60%

Isolation voltage shall be measured using the following method.

- (1) Short between anode and cathode on the primary side and between collector and emitter on the secondary side.
- (2) The isolation voltage tester with zero-cross circuit shall be used.
- (3) The waveform of applied voltage shall be a sine wave.

*2. For 10 Seconds

Photocoupler LTV-305X series

4.2 ELECTRICAL OPTICAL CHARACTERISTICS at Ta=25°C

Parameter		Symbol	Min.	Typ.	Max.	Unit	Test Condition	
Input	Forward Voltage	V_F	—	1.15	1.5	V	$I_F=20\text{mA}$	
	Reverse Current	I_R	—	—	10	μA	$V_R=6\text{V}$	
Output	*1 Peak Blocking Current, Either Direction	I_{DRM}	—	10	100	nA	$V_{DRM}=600\text{V}$	
	Peak On-State Voltage, Either Direction	V_{TM}	—	1.7	3	V	$I_{TM}=100\text{ mA Peak}$	
	*2 Critical Rate of Rise of Off-State Voltage	dv/dt	1000	—	—	V/ μs		
COUPLED	*3 Led Trigger Current, Current Required to Latch Output, Either Direction	LTV-3050	I_{FT}	—	—	30	mA	Main Terminal Voltage = 3V
		LTV-3051		—	—	15		
		LTV-3052		—	—	10		
		LTV-3053		—	—	5		
	Holding Current, Either Direction	I_H	—	250	—	μA		

*1 Test voltage must be applied within dv/dt rating.

*2 This is static dv/dt. Commutating dv/dt is a function of the load-driving thyristor(s) only.

*3 All devices are guaranteed to trigger at an I_F value less than or equal to max I_{FT} .

Photocoupler LTV-305X series

5. CHARACTERISTICS CURVES (TYPICAL PERFORMANCE)

Fig.1 Forward Current vs. Ambient Temperature

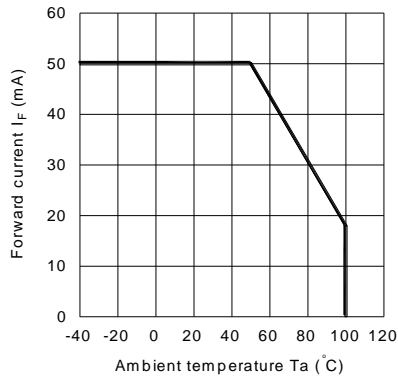

Fig.2 On-state Current vs. Ambient Temperature

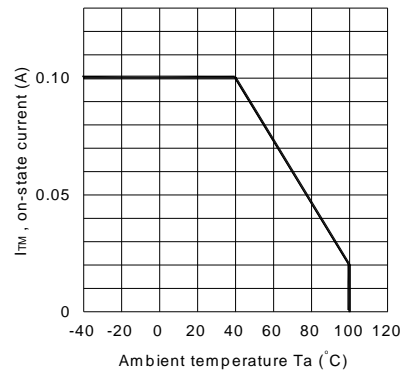

Fig.3 Minimum Trigger Current vs. Ambient Temperature

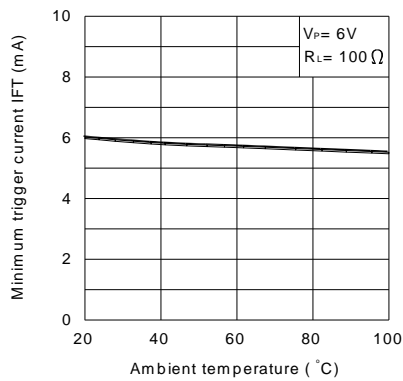

Fig.4 Forward Current vs. Forward Voltage

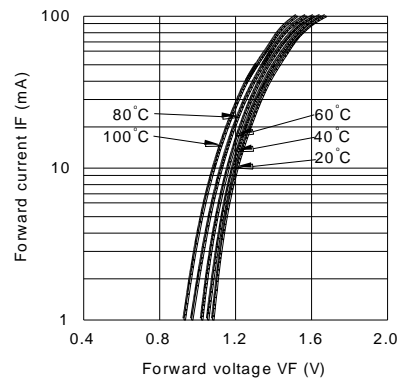

Fig.5 On-state Voltage vs. Ambient Temperature

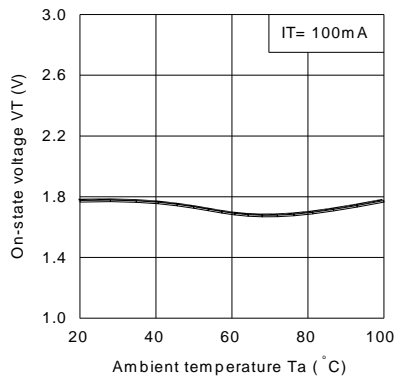
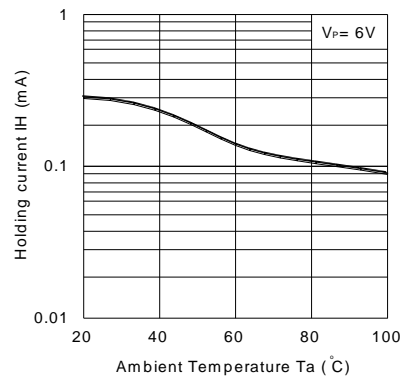

Fig.6 Holding Current vs. Ambient Temperature



Photocoupler LTV-305X series

Fig.7 Repetitive Peak Off-state Current vs. Temperature

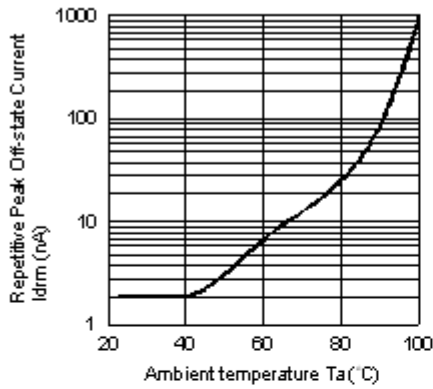
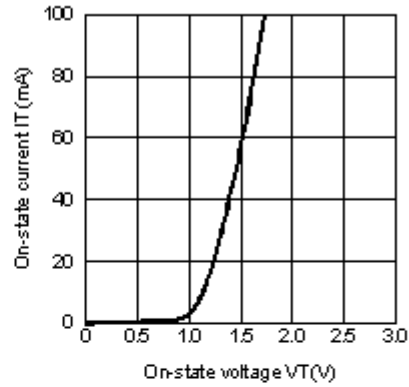
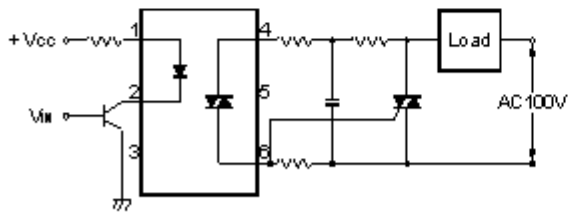

Fig.8 On-state Current vs. On-state Voltage



Basic Operation Circuit

Medium/High Power Triac Drive Circuit



Photocoupler LTV-305X series

6. TEMPERATURE PROFILE OF SOLDERING

6.1 IR Reflow soldering (JEDEC-STD-020C compliant)

One time soldering reflow is recommended within the condition of temperature and time profile shown below. Do not solder more than three times.

Profile item	Conditions
Preheat	
- Temperature Min (T_{Smin})	150°C
- Temperature Max (T_{Smax})	200°C
- Time (min to max) (ts)	90±30 sec
Soldering zone	
- Temperature (T_L)	217°C
- Time (t_L)	60 sec
Peak Temperature (T_P)	260°C
Ramp-up rate	3°C / sec max.
Ramp-down rate	3~6°C / sec

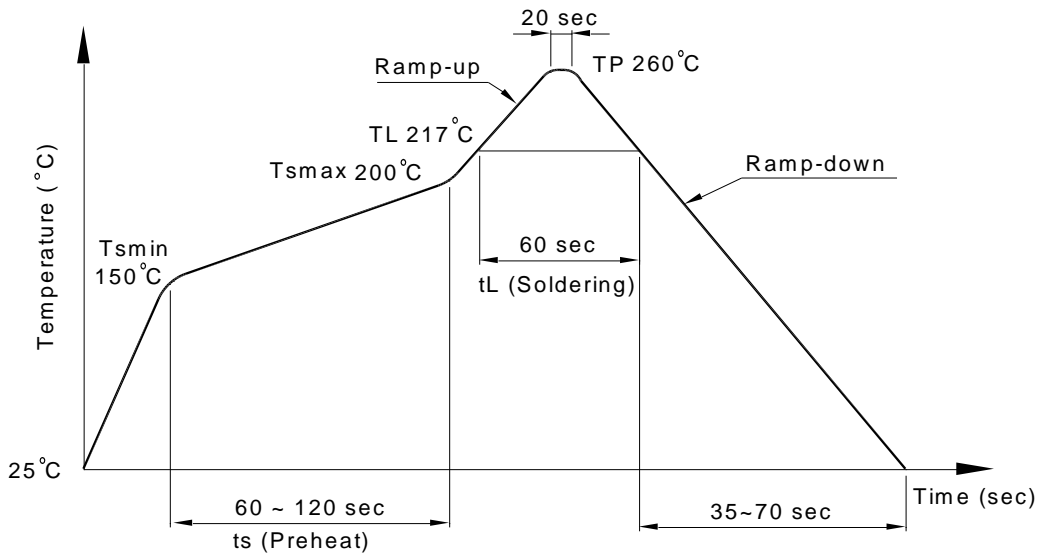

**Photocoupler
LTV-305X series**

6.2 Wave soldering (JEDEC22A111 compliant)

One time soldering is recommended within the condition of temperature.

Temperature: $260 \pm 0 / -5^\circ\text{C}$

Time: 10 sec.

Preheat temperature: 25 to 140°C

Preheat time: 30 to 80 sec.

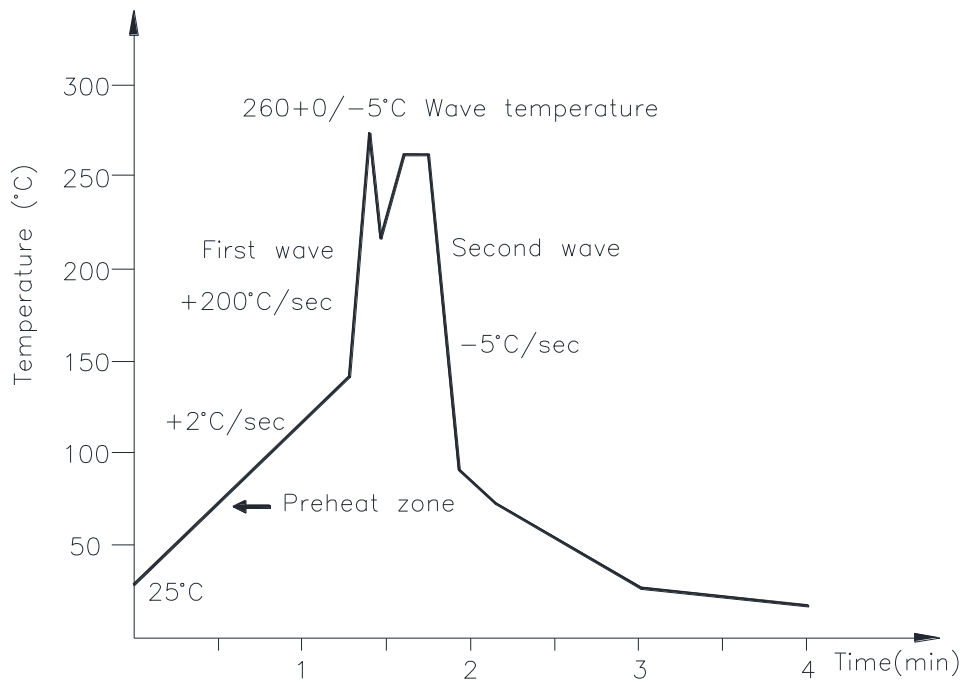

6.3 Hand soldering by soldering iron

Allow single lead soldering in every single process. One time soldering is recommended.

Temperature: $380 \pm 0 / -5^\circ\text{C}$

Time: 3 sec max.

**Photocoupler
LTV-305X series**

7. RRECOMMENDED FOOT PRINT PATTERNS (MOUNT PAD)

Unit: mm

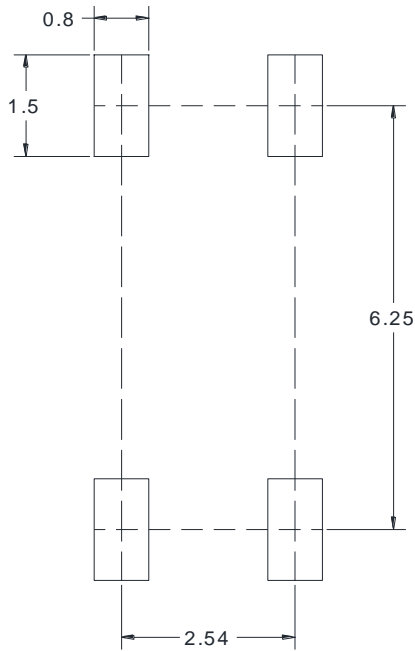

**Photocoupler
LTV-305X series**

8. NAMING RULE

LTV-305(X)(1)

DEVICE PART NUMBER ————↑
Please refer to Electrical Optical
Characteristics Table on Page P5

(1) TAPING TYPE (TP or no suffix) ————↑

Example : LTV-3051-TP1

LTV305(X)(1)-V

DEVICE PART NUMBER ————↑
Please refer to Electrical Optical
Characteristics Table on Page P5

(1) TAPING TYPE (TP or no suffix) ————↑

(2) VDE option ————↑

Example : LTV3051TP1-V

9. NOTES

- LiteOn is continually improving the quality, reliability, function or design and LiteOn reserves the right to make changes without further notices.
- The products shown in this publication are designed for the general use in electronic applications such as office automation equipment, communications devices, audio/visual equipment, electrical application and instrumentation.
- For equipment/devices where high reliability or safety is required, such as space applications, nuclear power control equipment, medical equipment, etc, please contact our sales representatives.
- When requiring a device for any "specific" application, please contact our sales in advice.
- If there are any questions about the contents of this publication, please contact us at your convenience.
- The contents described herein are subject to change without prior notice.
- Immerge unit's body in solder paste is not recommended.