



RM96

miniature relays



- Height 16,2 mm • IP 40 and IP 67
- For PCB (1 CO, 1 NO, 1 NC) and plug-in sockets (1 CO)
- Accessories: sockets and modules for 1 CO
- DC coils, insulation class F: 155 °C
- Recyclable packing
- Terminals: 3,2 mm for version 1 CO,
5,0 mm for version 1 NO and 1 NC
- Recognitions, certifications, directives: RoHS,   

Contact data

Number and type of contacts	1 CO, 1 NO, 1 NC	
Contact material	AgSnO₂ , AgSnO ₂ /Au hard gold plating, AgCdO ^①	
Rated / max. switching voltage	AC	250 V / 400 V
Min. switching voltage		10 V AgSnO ₂ , 5 V AgSnO ₂ /Au hard gold plating, 10 V AgCdO
Rated load (capacity)	AC1	8 A / 250 V AC
	AC15	3 A / 120 V 1,5 A / 240 V (B300)
	DC1	8 A / 24 V DC (see Fig. 3)
	DC13	0,22 A / 120 V 0,1 A / 250 V (R300)
Motor load	acc. to UL 508	1/2 HP 240 V AC, 4,9 FLA, single-phase motor ^②
	AC3 acc. to IEC 60947-4-1	0,37 kW 240 V AC, single-phase motor
Min. switching current		10 mA AgSnO ₂ , 2 mA AgSnO ₂ /Au hard gold plating, 5 mA AgCdO
Max. inrush current		15 A
Rated current		8 A
Max. breaking capacity	AC1	2 000 VA
Min. breaking capacity		1 W AgSnO ₂ , 0,05 W AgSnO ₂ /Au hard gold plating, 0,5 W AgCdO
Contact resistance		≤ 100 mΩ
Max. operating frequency	• at rated load AC1	600 cycles/hour
	• no load	72 000 cycles/hour
Coil data		
Rated voltage	DC	5, 6, 9, 12 , 18, 24 , 48 V
Must release voltage		DC: ≥ 0,1 U _n
Operating range of supply voltage		see Table 1 and Fig. 4
Rated power consumption	DC	0,22...0,3 W
Insulation according to EN 60664-1		
Insulation rated voltage		400 V AC
Rated surge voltage		4 000 V 1,2 / 50 μs
Overvoltage category		III
Insulation pollution degree		3
Dielectric strength	• between coil and contacts	4 000 V AC type of insulation: reinforced
	• contact clearance	1 000 V AC type of clearance: micro-disconnection
Contact - coil distance	• clearance	≥ 8 mm
	• creepage	≥ 8 mm
General data		
Operating / release time (typical values)		10 ms / 5 ms
Electrical life (number of cycles)	• resistive AC1	> 10 ⁵ 8 A, 250 V AC
	• cosφ	see Fig. 2
Mechanical life (cycles)		> 2 x 10 ⁷
Dimensions (L x W x H)	1 CO:	30 x 10 x 16,2 mm
	1 NO, 1 NC:	28 x 10 x 16,2 mm
Weight		11 g
Ambient temperature (non-condensation and/or icing)	• storage	-40...+85 °C
	• operating	-40...+80 °C
Cover protection category		IP 40 or IP 67 EN 60529
Environmental protection		RTII EN 61810-7
Shock resistance		20 g
Vibration resistance		10 g 10...150 Hz
Solder bath temperature		max. 270 °C
Soldering time		max. 5 s

The data in bold type relate to the standard versions of the relays. ^① AgCdO contact material in electrical contacts is only for use in electrical and electronic equipment (EEE) in compliance with directive RoHS2 2011/65/EU in restricted categories of EEE covered by this directive. Relpol S.A. is not responsible for usage relays with AgCdO contact material in categories of EEE where it is prohibited by the directive RoHS2 2011/65/EU. ^② For single phase motors for 110-120 V AC do not use motors with higher FLA than given for 240 V AC.

RM96

miniature relays

Dimensions

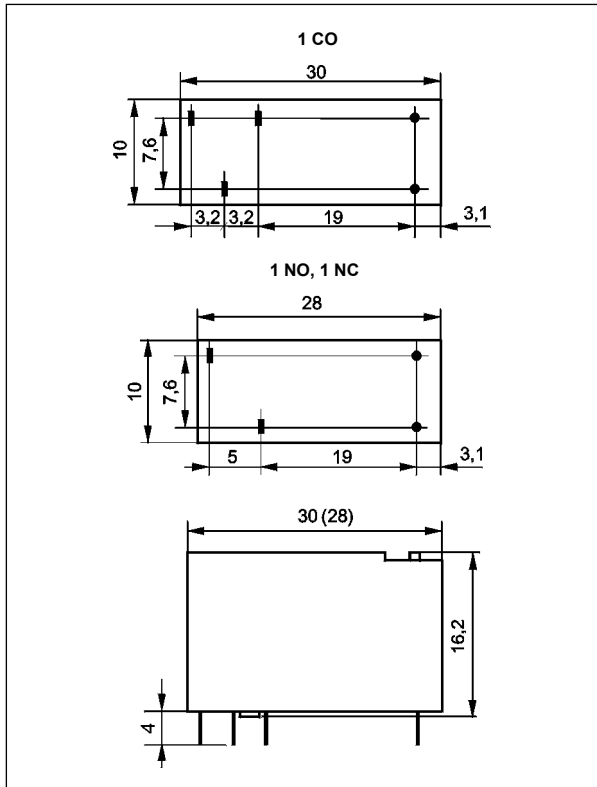

Connection diagrams (pin side view)

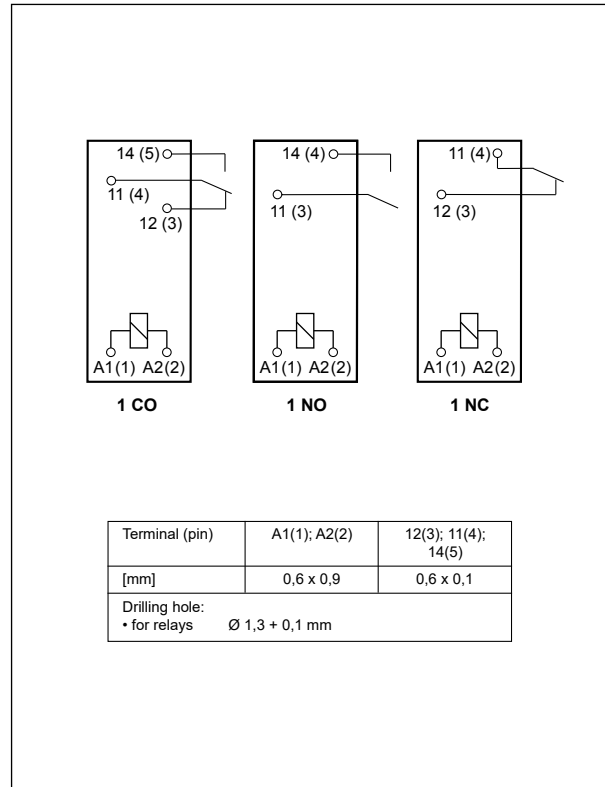

Pinout (solder side view)

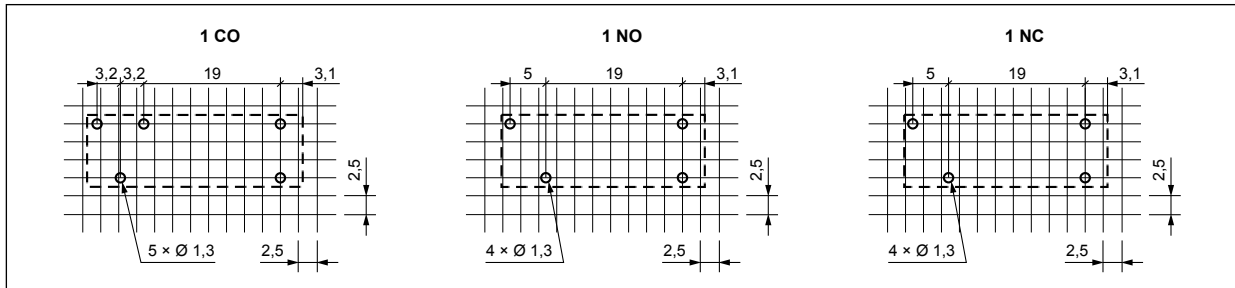

Print on relay cover

Type marking on relays cover **RM96** do not match the ordering codes (examples of marking for **RM96-1011-35-1012** and **RM96-3021-25-1024**).

RM96P-12-W
 \square DC 24V
 AC 250V 8A
 4 \square 5
 3

Contact material AgCdO
 without marks
 - AgCdO

Contact material AgSnO_2
 AgSnO₂
 - AgSnO₂
 AgSnO₂+Au
 - AgSnO₂/Au hard gold plating

10A 250VAC

RM96Z-24
 \square DC 24V
 AC 250V 10A
 4 \square 5
 AgSnO₂

Number and type of contacts
 P - 1 CO
 Z - 1 NO
 R - 1 NC

Coil
 5 - 5 V DC
 ...
 48 - 48 V DC

Cover protection category
 without marks - IP 40
 W - IP 67

10A 250VAC

Electrical life at AC resistive current.
 $U_n = 230 \text{ V AC}$ - version 1 NO

Fig. 1

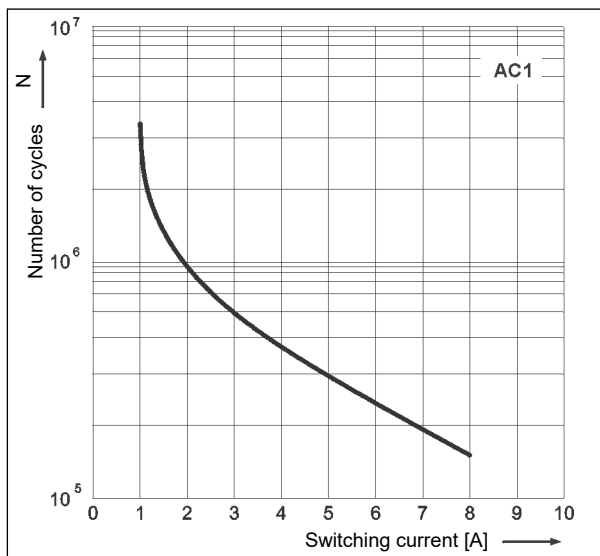

Electrical life reduction factor at AC inductive load

Fig. 2

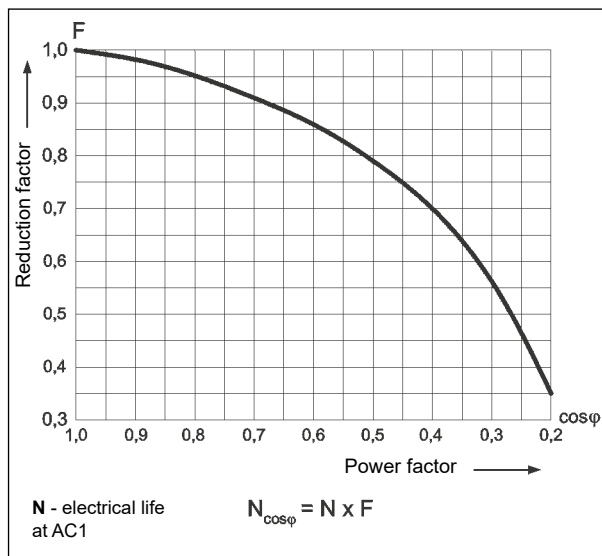

Max. breaking capacity
A - resistive load DC1
B - resistive load AC1

Fig. 3

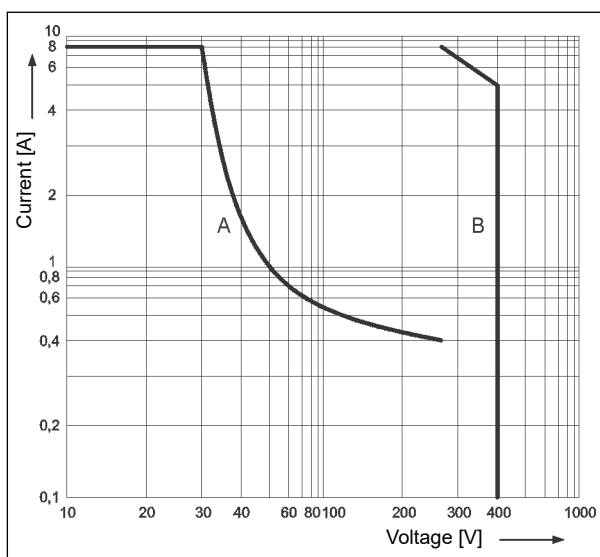

Coil operating range - DC

Fig. 4

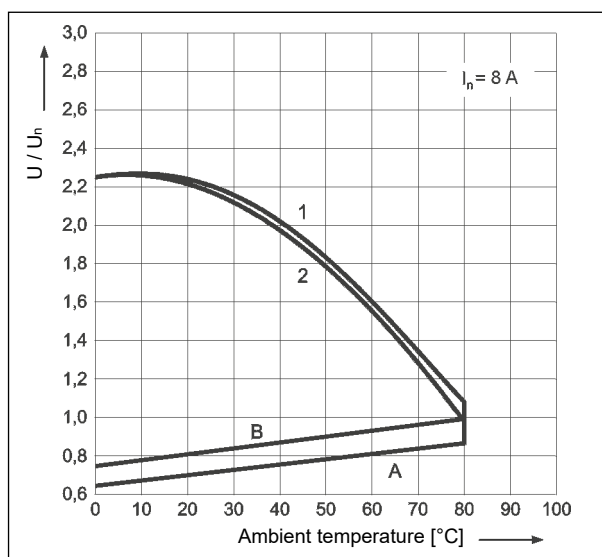

Description of Fig. 4

A - relations between make voltage and ambient temperature at no load on contacts. Coil temperature and ambient temperature are equal before coil energizing. Make voltage is not higher than the value read on Y axis (multiplication of rated voltage).

B - relations between make voltage and ambient temperature after initial coil heating up with $1,1 U_n$, at continues load of I_n on contacts. Make voltage is not higher than the value read on Y axis (multiplication of rated voltage).

1, 2 - values on Y axis represent allowed overvoltage on coil at certain ambient temperature and contact load:

- 1** - no load
- 2** - rated load

ES 32

Screw terminals
 plug-in socket
 for RM96 1 CO
 - see page 5

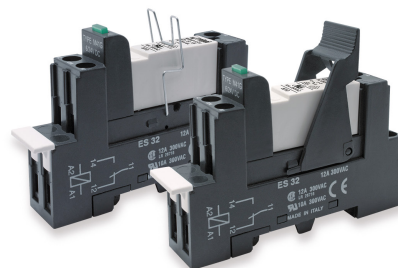



RM96



miniature relays

Mounting

Relays **RM96 1 NO** (one normally open contact) and **RM96 1 NC** (one normally closed contact) are designed for direct PCB mounting.

Relays **RM96 1 CO** (one changeover contact) are designed for: • direct PCB mounting • plug-in sockets.

Sockets for RM96 1P	Accessories			Additional features
	Retainer / retractor clips	Spring wire clips	Description plates	
Screw terminals sockets , 35 mm rail mount (acc. to EN 60715) or on panel mounting (one M3 screw)				
ES 32	MS 16, GZMB80-0040	GZM80-0041	TR	modules  , strips 

 Signalling / protecting modules type M... - see page 6.  Interconnection strips ZGGZ80 - see page 7.

Coil data - DC voltage version

Table 1

Coil code	Rated voltage V DC	Coil resistance at 20 °C Ω	Acceptable resistance	Coil operating range V DC	
				min. (at 20 °C)	max. (at 20 °C)
1005	5	110	± 10%	3,5	12,0
1006	6	160	± 10%	4,2	14,5
1009	9	360	± 10%	6,3	22,0
1012	12	660	± 10%	8,4	29,5
1018	18	1 500	± 10%	12,6	44,0
1024	24	2 200	± 10%	16,8	54,0
1048	48	8 000	± 10%	33,6	102,0

The data in bold type relate to the standard versions of the relays.

Ordering codes

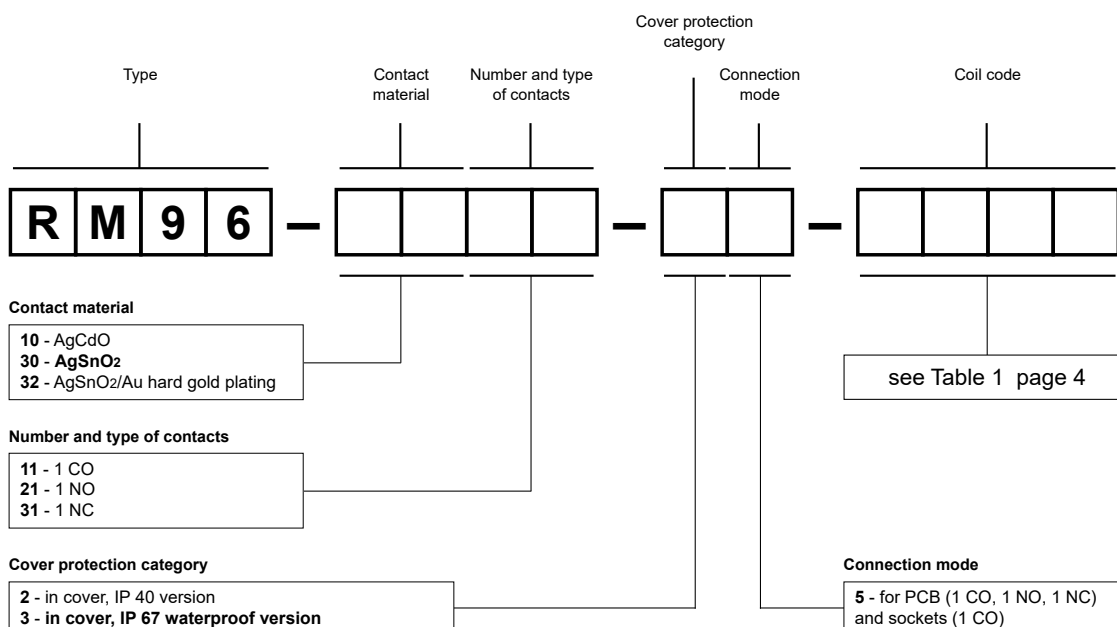

Examples of ordering codes:

RM96-1011-35-1012

relay **RM96**, for PCB and sockets, one changeover contact, contact material AgCdO, coil voltage 12 V DC, in cover IP 67

RM96-3021-25-1024

relay **RM96**, for PCB, one normally open contact, contact material AgSnO₂, coil voltage 24 V DC, in cover IP 40

Plug-in sockets and accessories

ES 32

For RM96 1 CO

Screw terminals
Max. tightening moment
for the terminal: 0,5 Nm
35 mm rail mount
acc. to EN 60715
or on panel mounting
75 x 15,5 x 42,5(59) mm ^②
One pole, 3,2 mm pinout
12 A, 300 V AC



Connection diagrams

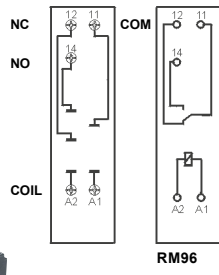

RM96

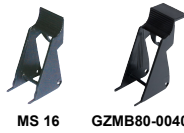

MS 16

GZMB80-0040



TR



Module type M...



ZGGZ80



GZM80-0041

Accessories ^①

Dimensions

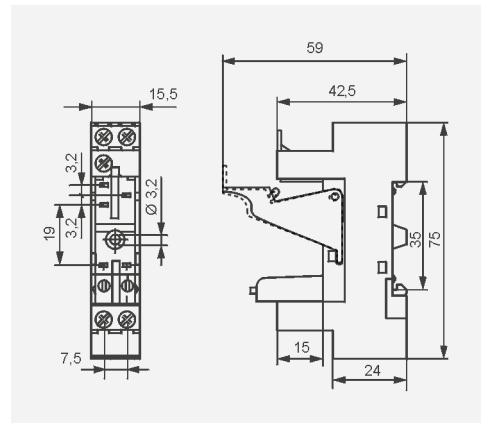

- ^① Mounting and sub-assemblies of accessories in the socket - see page 5. Signalling / protecting modules type M... - see page 6.
- ^② In the bracket the height of socket with retainer / retractor clip is shown.

Mounting and sub-assemblies of the relay and accessories in the socket

Signalling / protecting
module type M...



Retainer / retractor clip



Electromagnetic
relay

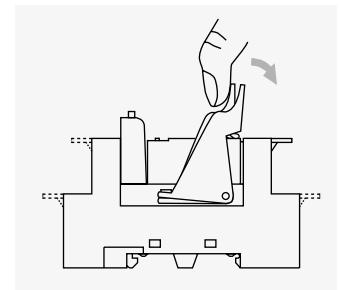
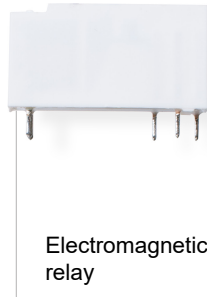

Removing the relay from the socket
with a retractor / retractor clip



Description plate

Screw terminals
plug-in socket



PRECAUTIONS:

1. Ensure that the parameters of the product described in its specification provide a safety margin for the appropriate operation of the device or system and never use the product in circumstances which exceed the parameters of the product. 2. Never touch any live parts of the device. 3. Ensure that the product has been connected correctly. An incorrect connection may cause malfunction, excessive heating or risk of fire. 4. In case of any risk of any serious material loss or death or injuries of humans or animals, the devices or systems shall be designed so to equip them with double safety system to guarantee their reliable operation.

Signalling / protecting modules type M...

For sockets type:

GZT80, GZM80, GZS80, GZMB80, GZT92, GZM92, GZS92, ES 32, GZT2, GZM2, GZMB2, GZT3, GZM3, GZT4, GZM4, GZMB4

Modules type M... are parallelly connected with relay coil.

Polarity P: -A1/+A2. Polarity N: +A1/-A2.

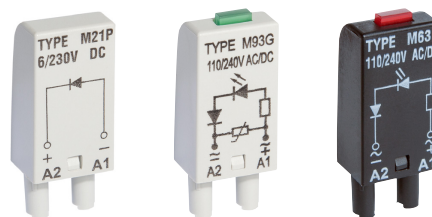

Modules type M...	Layout	Voltage	Type of module ① ②
Module D (polarization P) It limits overvoltage on DC coils.		6/230 V DC	M21P
Module D (polarization N) It limits overvoltage on DC coils.		6/230 V DC	M21N
Module LD (polarization P) It limits overvoltage on DC coils. Coil energizing indication.		6/24 V DC 24/60 V DC 110/230 V DC	M31R, M31G M32R, M32G M33R, M33G
Module LD (polarization N) It limits overvoltage on DC coils. Coil energizing indication.		6/24 V DC 24/60 V DC 110/230 V DC	M41R, M41G M42R, M42G M43R, M43G
Module RC It protects against EMC disturbance. It limits overvoltage.		6/24 V AC/DC 24/60 V AC/DC 110/240 V AC/DC	M51 M52 M53
Module L Coil energizing indication.		6/24 V AC/DC 24/60 V AC/DC 110/240 V AC/DC	M61R, M61G M62R, M62G M63R, M63G
Module LV It limits overvoltage on AC and DC coils. Coil energizing indication.		6/24 V AC/DC 24/60 V AC/DC 110/240 V AC/DC	M91R, M91G M92R, M92G M93R, M93G
Module V It limits overvoltage on AC coils. No indication.		6/24 V AC 110/130 V AC 220/240 V AC	M71 M72 M73
Module R It limits harmful voltage on AC coils induced in long lines which causes unwanted making of the relay.		110/240 V AC	M103

① M...R - LED red, M...G - LED green

② When ordering modules indicate their color: gray or black.

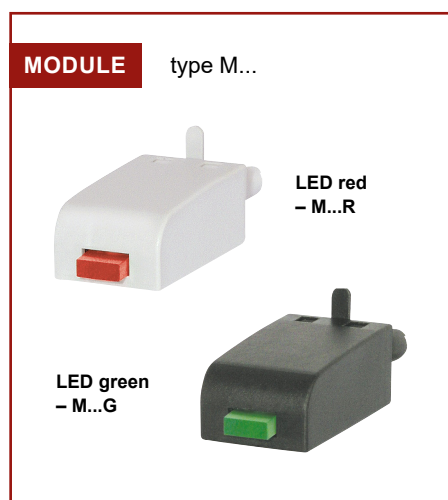

Interconnection strips ZGGZ80



PI85-...-MS-...
(RM85 + GZM80)

ZGGZ80

ZGGZ80 for:

Plug-in sockets	Relays for plug-in sockets	Interface relays ③
GZT80	RM84, RM85, RM85 inrush, RM85 105 °C sensitive, RM87L ④, RM87P ④, RM87N ④	PI84-...-TS-... (RM84 + GZT80)
GZM80		PI84-...-MS-... (RM84 + GZM80)
GZS80		PI85-...-TS-... (RM85 + GZT80)
GZT92		(RM85 inrush + GZT80)
GZM92		PI85-...-MS-... (RM85 + GZM80)
GZS92		
ES 32	RM96 1 CO	

③ Interface relay PI84 (PI85) is offered as a set: plug-in socket GZT80 or GZM80 + miniature relay RM84 (RM85) + signalling / protecting module type M... + retainer / retractor clip GZT80-0040 + description plate GZT80-0035. ④ Also versions RM87. sensitive

Interconnection strip ZGGZ80

- designed for the co-operation with plug-in sockets of miniature relays and with interface relays PI84 and PI85, which are equipped with screw terminals; sockets and relays are mounted on 35 mm rail mount acc. to EN 60715,
- bridges common input signals (coil terminals A1 or A2) or output signals - see photo at the top,
- maximum permissible current is 10 A / 250 V AC,
- possibility of connection of 8 sockets or relays,
- colours of strips: **ZGGZ80-1** grey, **ZGGZ80-2** black.

