

AK4100/..-5.0-PEBBLE GREY

- 1- to n-poles

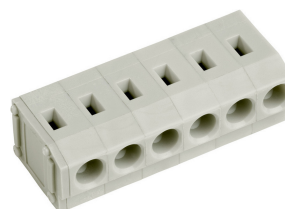

A Phoenix Mecano Brand

Technical Data

Wire sizes		Insulating Material	
Solid min	0.08 mm ²	Material	PA 6.6
Solid max	2.5 mm ²	Flammability Class	UL 94 V-0
Stranded (flexible) min	0.08mm ²	Temperatures	
Stranded (flexible) max	2.5 mm ²	Operating Temperature (without mech. load)	-40 °C - 105 °C
Stranded with Ferrule min	0.14 mm ²	Store Temperature	-40 °C - 105 °C
Stranded with Ferrule max	1.0 mm ²	Wave Soldering Process	
Dimensions		Soldering Temperature, recommended	260 °C
Stripped Length	9.0 mm	Peak Soldering Time, recommended	3-4 s
PCB Hole Diameter	1.0 mm	Reflow Process	
Materials		Soldering Temperature, recommended	-
Solder Tab	Copper Alloy	Peak Soldering Time, recommended	-
Clamp Spring	Stainless Steel		

Colours

	PEBBLE GREY, RAL 7032
	BLUE, RAL 5015

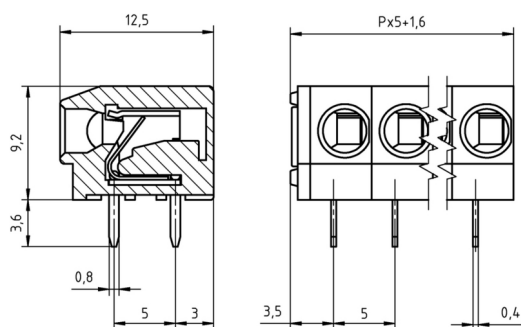

Colours according to RAL, there may be variations on colour due to production conditions. Special colours on request.





Order Data (Spacing 5.0 mm)

Poles	Width (mm)	Article Designation	Article Number	PU
1	6.60	AK4100/1-5.0-PEBBLE GREY	54100010001 G	250
2	11.60	AK4100/2-5.0-PEBBLE GREY	54100020001 F	200
3	16.60	AK4100/3-5.0-PEBBLE GREY	54100030001 F	200
4	21.60	AK4100/4-5.0-PEBBLE GREY	54100040001 E	100
5	26.60	AK4100/5-5.0-PEBBLE GREY	54100050001 E	100
6	31.60	AK4100/6-5.0-PEBBLE GREY	54100060001 D	50
7	36.60	AK4100/7-5.0-PEBBLE GREY	54100070001 D	50
8	41.60	AK4100/8-5.0-PEBBLE GREY	54100080001 D	50
9	46.60	AK4100/9-5.0-PEBBLE GREY	54100090001 D	50
10	51.60	AK4100/10-5.0-PEBBLE GREY	54100100001 D	50
11	56.60	AK4100/11-5.0-PEBBLE GREY	54100110001 D	50
12	61.60	AK4100/12-5.0-PEBBLE GREY	54100120001 D	50

Accessoires

Figure	Designation	Article Number
	Bridge, 2-pole, insulated, BRI/2-5.0/5.08-LIGHT GREY	Order Data: 50000000006
	Bridge, 3-pole, insulated, BRI/3-5.0/5.08-LIGHT GREY	Order Data: 50000000007

Ratings

UseGroup					
	B	C	D		
Rated Voltage	300 V	-	300 V	250 V	
Rated Current	10 A	-	10 A	17.5 A	
Rated Wire Size				min	max
- solid	AWG 20-14	-	AWG 20-14	0.5 mm ²	2.5 mm ²
- stranded	-	-	-	-	-
Test Voltage	1.60 kV	-	1.60 kV	2.0 kV	