

Top View of Assembly

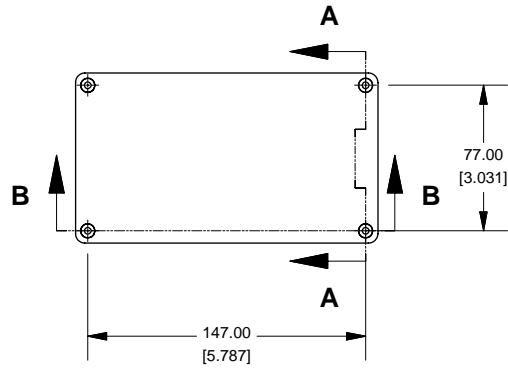

SECTION A-A End View of Assembly

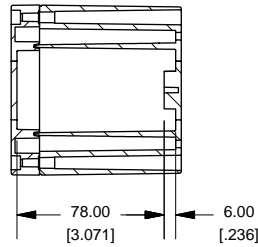

1554K

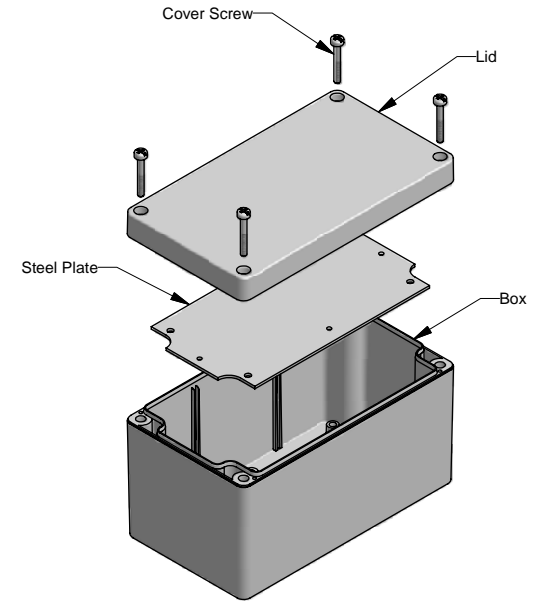

SECTION B-B Side View of Assembly

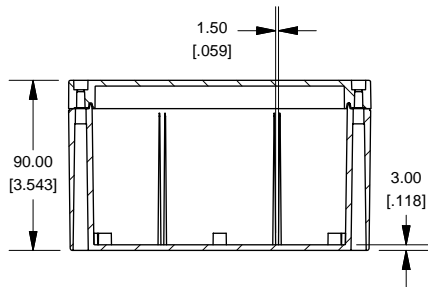

Top View Looking Inside Box

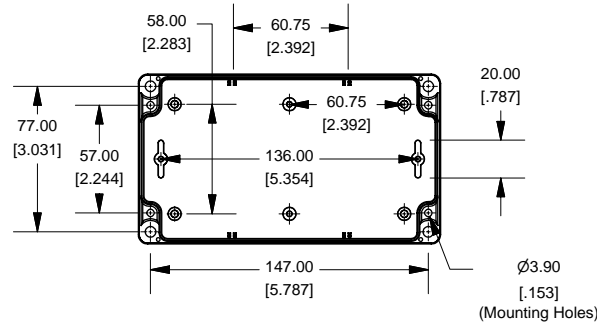

Lid

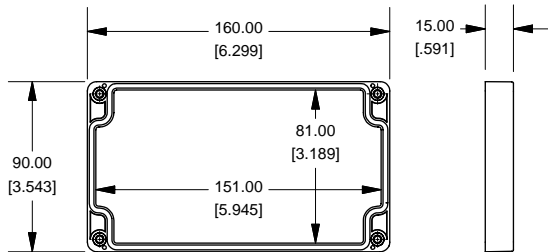

Available 16 Gauge Steel Plate

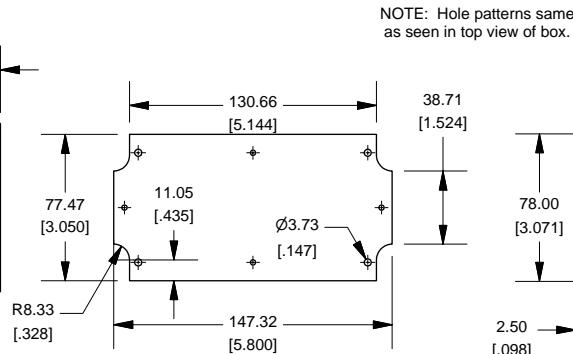

Maximum P.C. Board Size

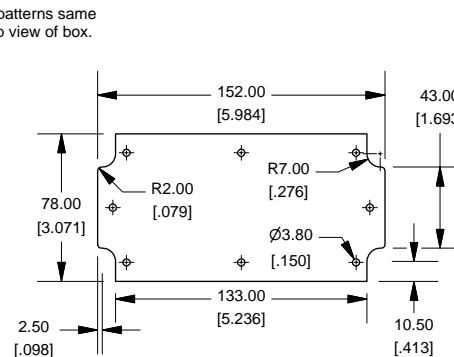

NOTE: Hole patterns same as seen in top view of box.

NOTE	
Purchased assembly includes box, lid and 4 cover screws.	
Cover screws should be torqued to 2.5 lbf-in (30 cN-m)	
Polycarbonate version is 508 approved	
Enclosure Type 4X, 4, 12 File# E65324	

1554K	
1554K Regular Enclosure	
General Purpose ABS	1554KGY
Polycarbonate	1554K2GY
1554K Clear Lid Enclosure	
Polycarbonate	1554K2GYCL
ACCESSORIES	
Heavy Duty 16 Gauge Galvanized Steel Panels	1554JPL
Steel Panel / P.C. Board Machine Screws [M3 X 8mm Nickel Plated]	1591MM100
Steel Panel / P.C. Board Self Tapping Screw [#6 X 1/4" (6.4mm) Nickel Plated]	1598ATS100
Cover Screws (Pkg 4) [M4 X 20mm Stainless Steel]	SC1554

